

Alphabet



A B C D E F G

H I J K L M N

O P Q R S T U

V W X Y Z

1 2 3 4 5

6 7 8 9 0

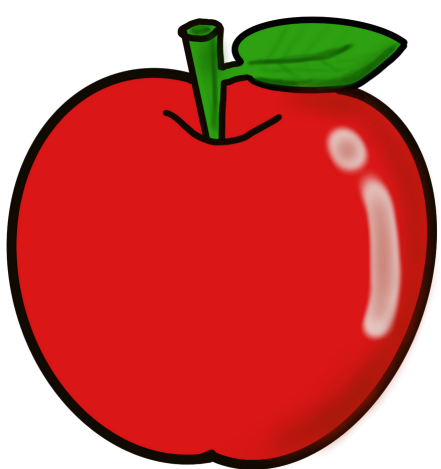
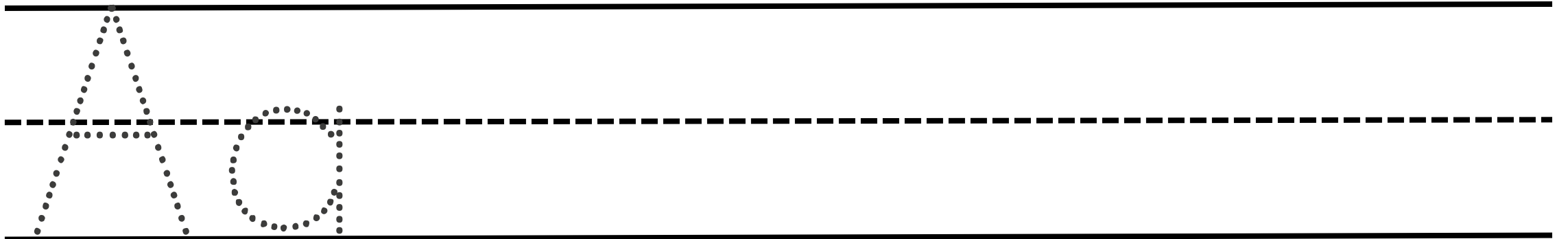
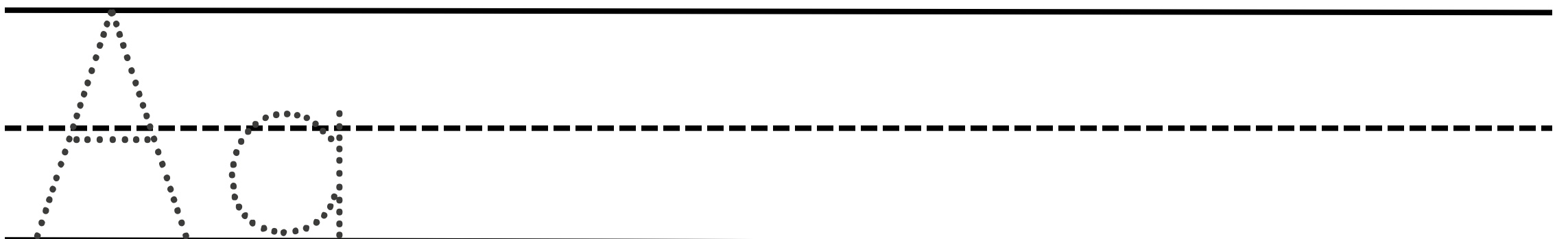
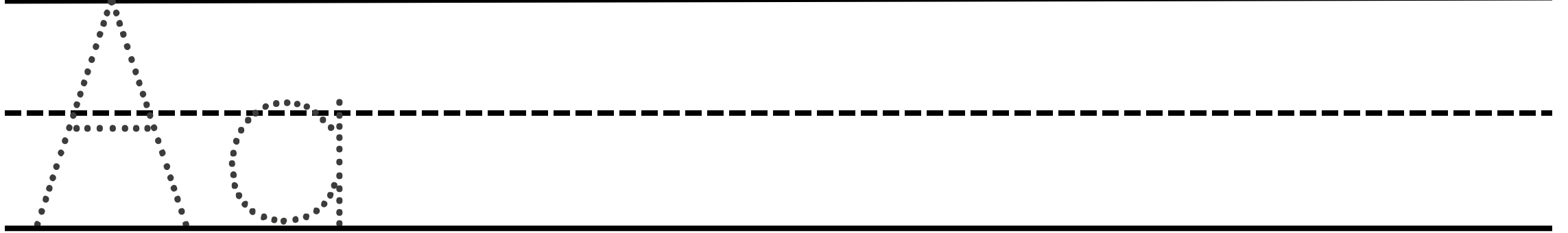
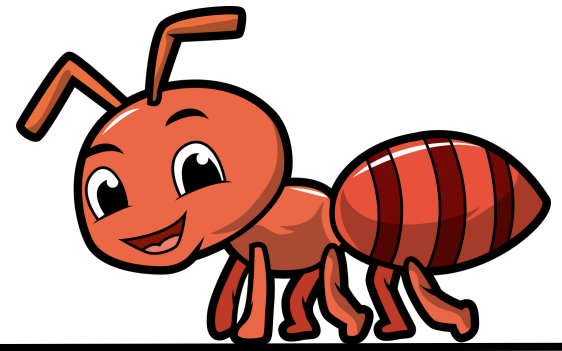
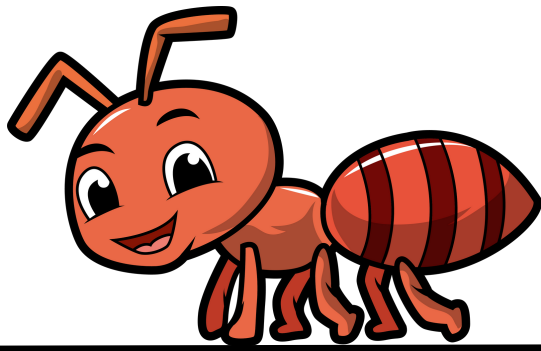
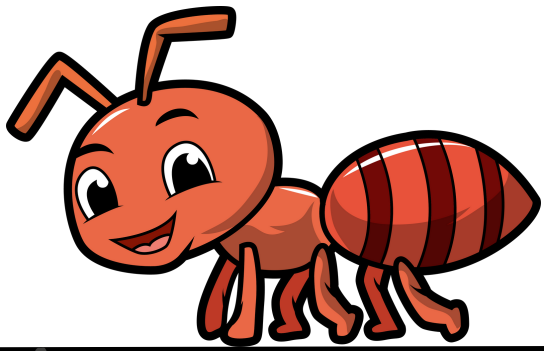
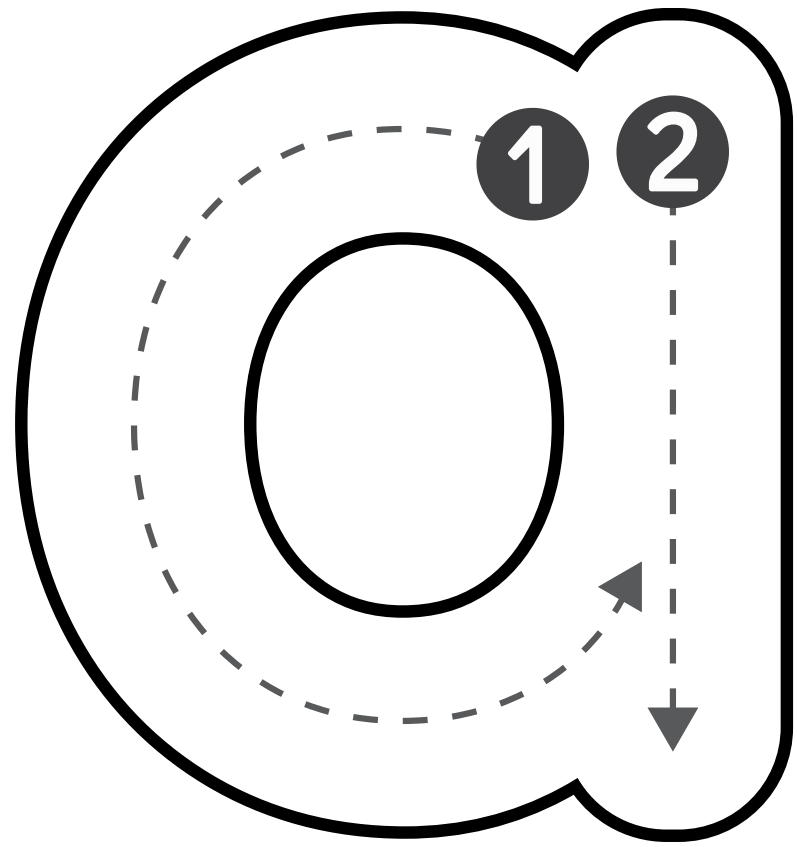
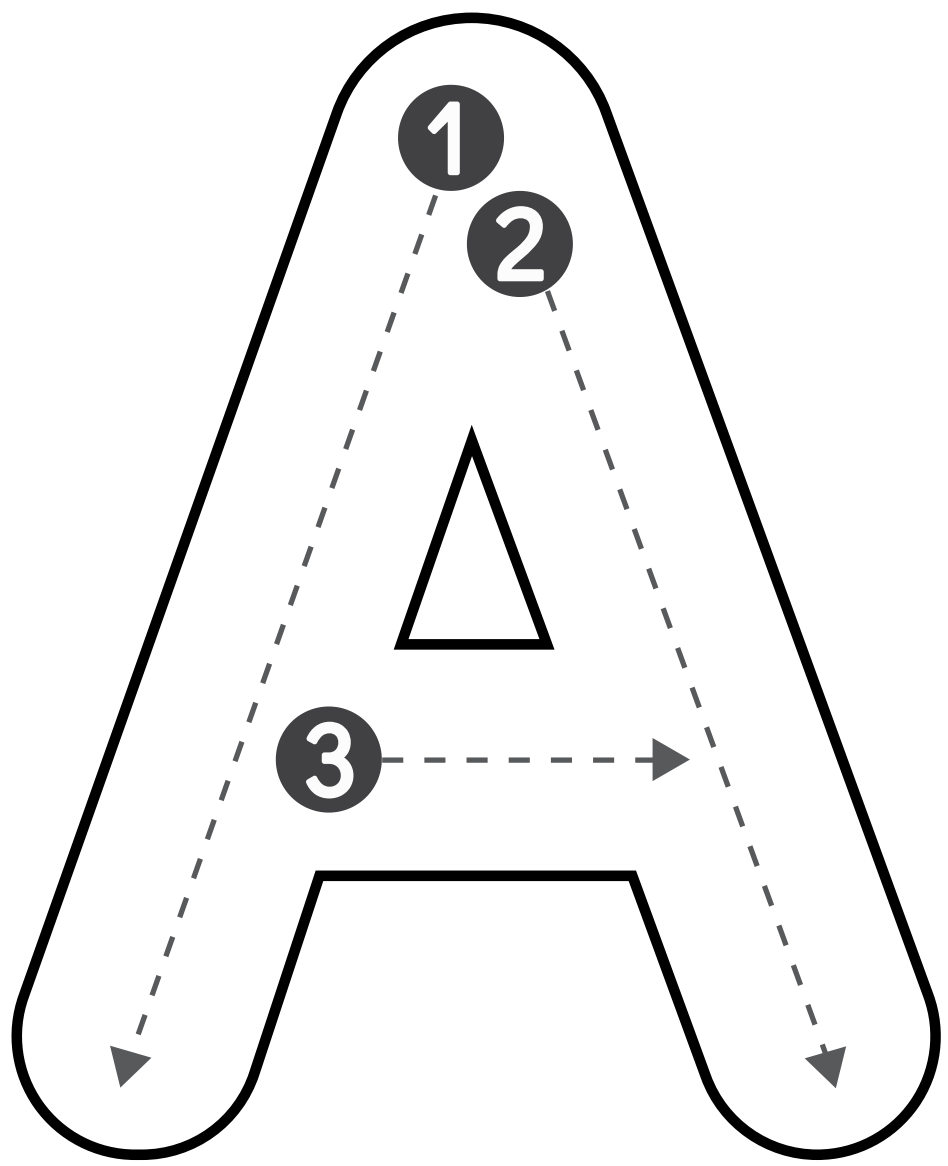

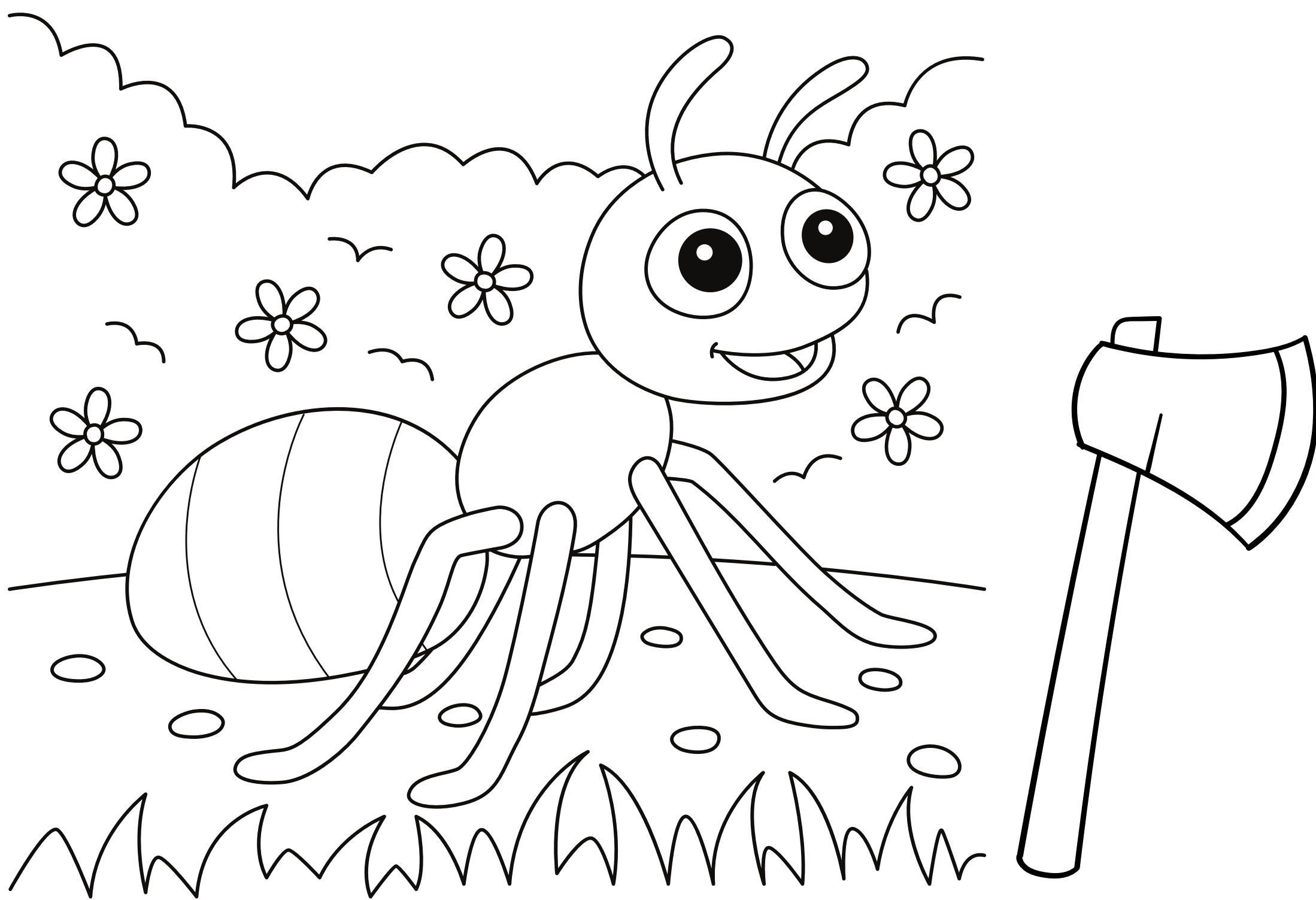
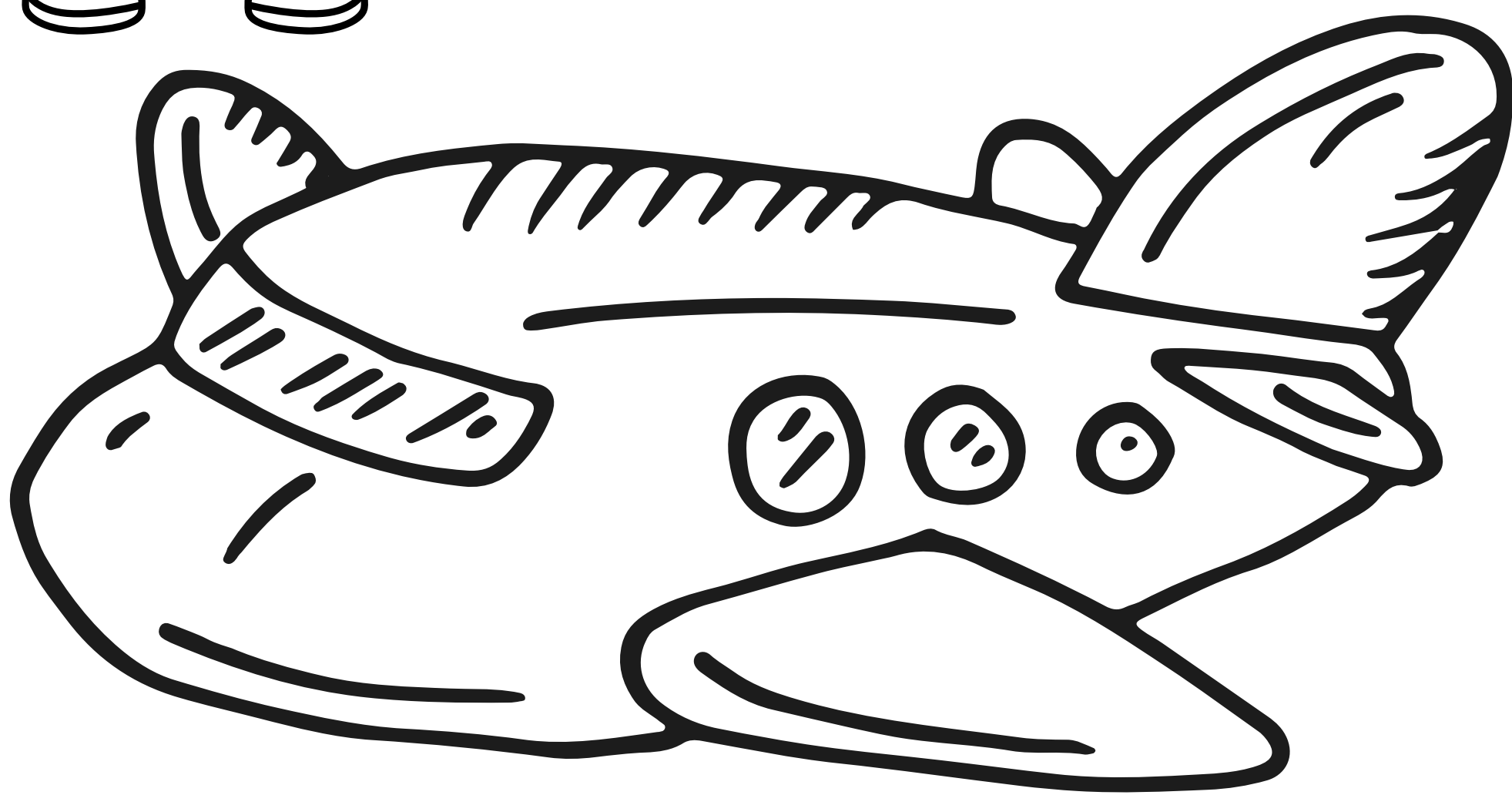
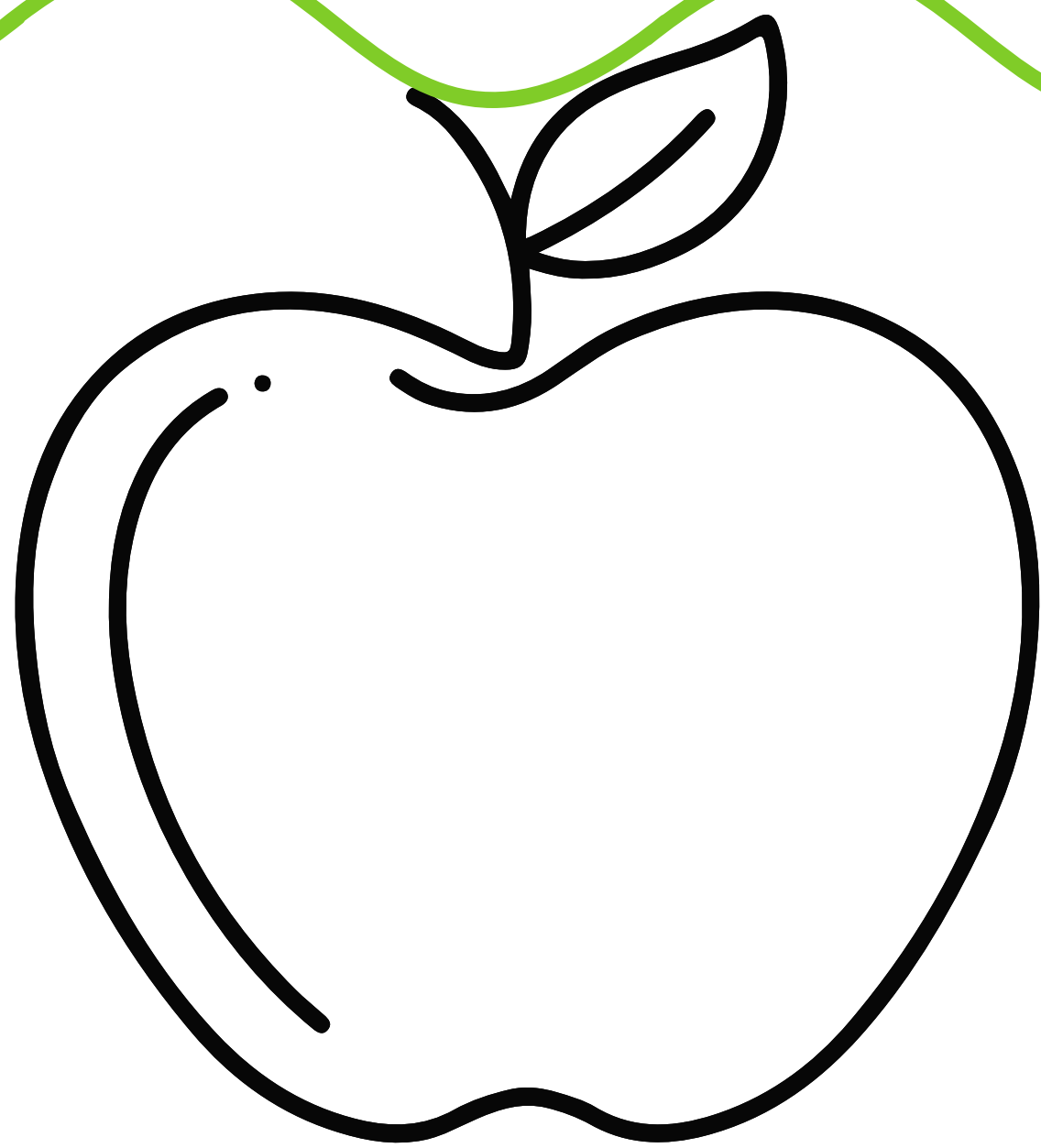
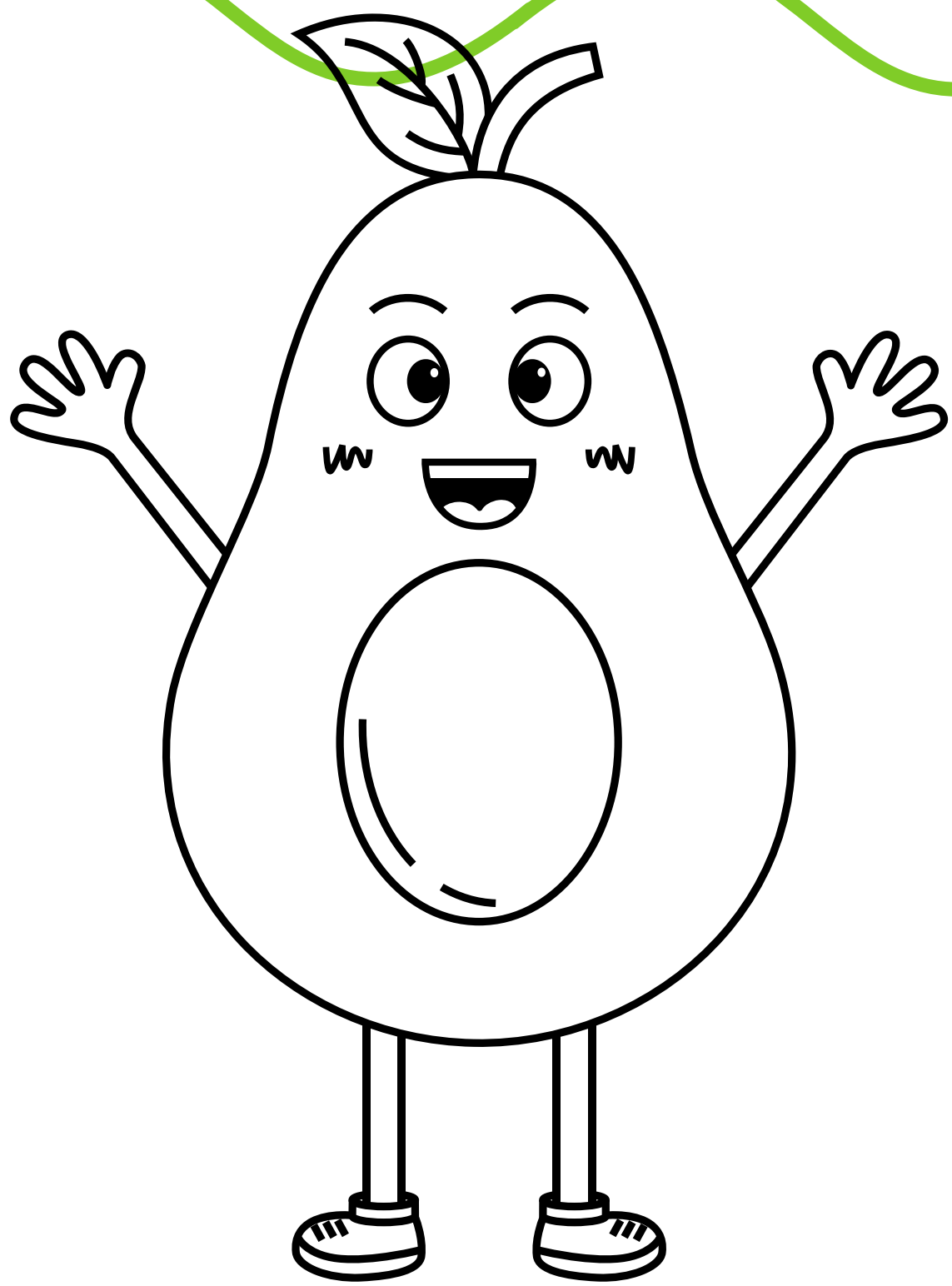

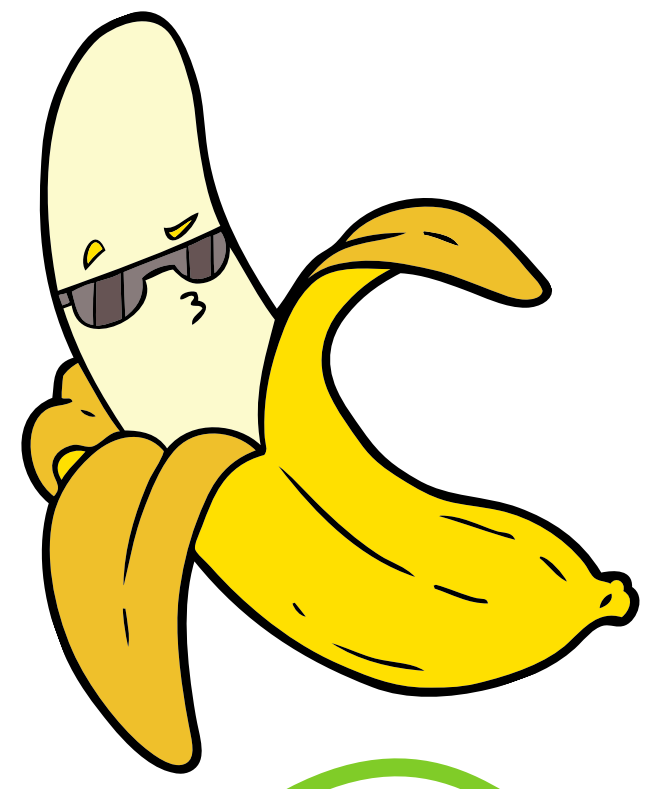
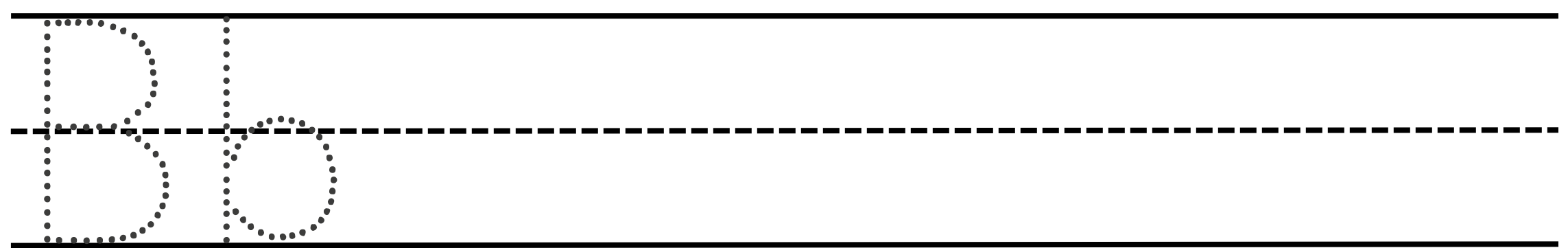
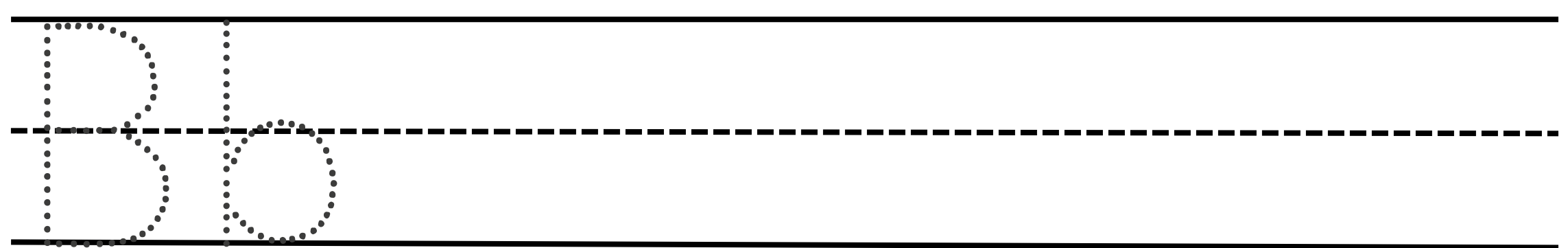
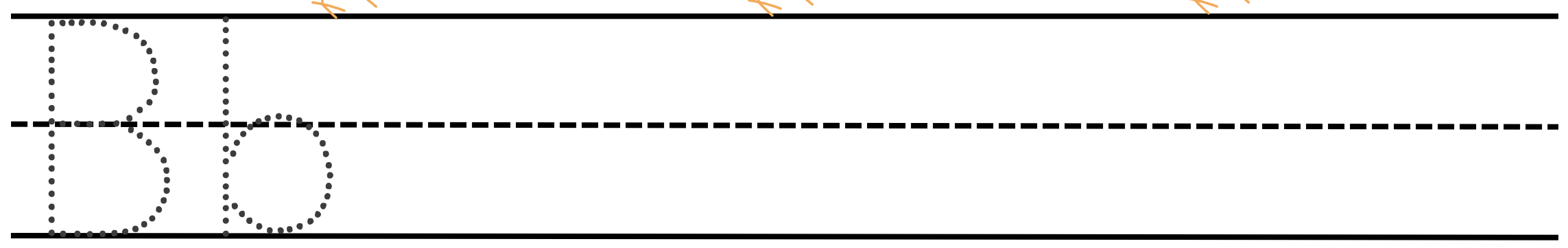
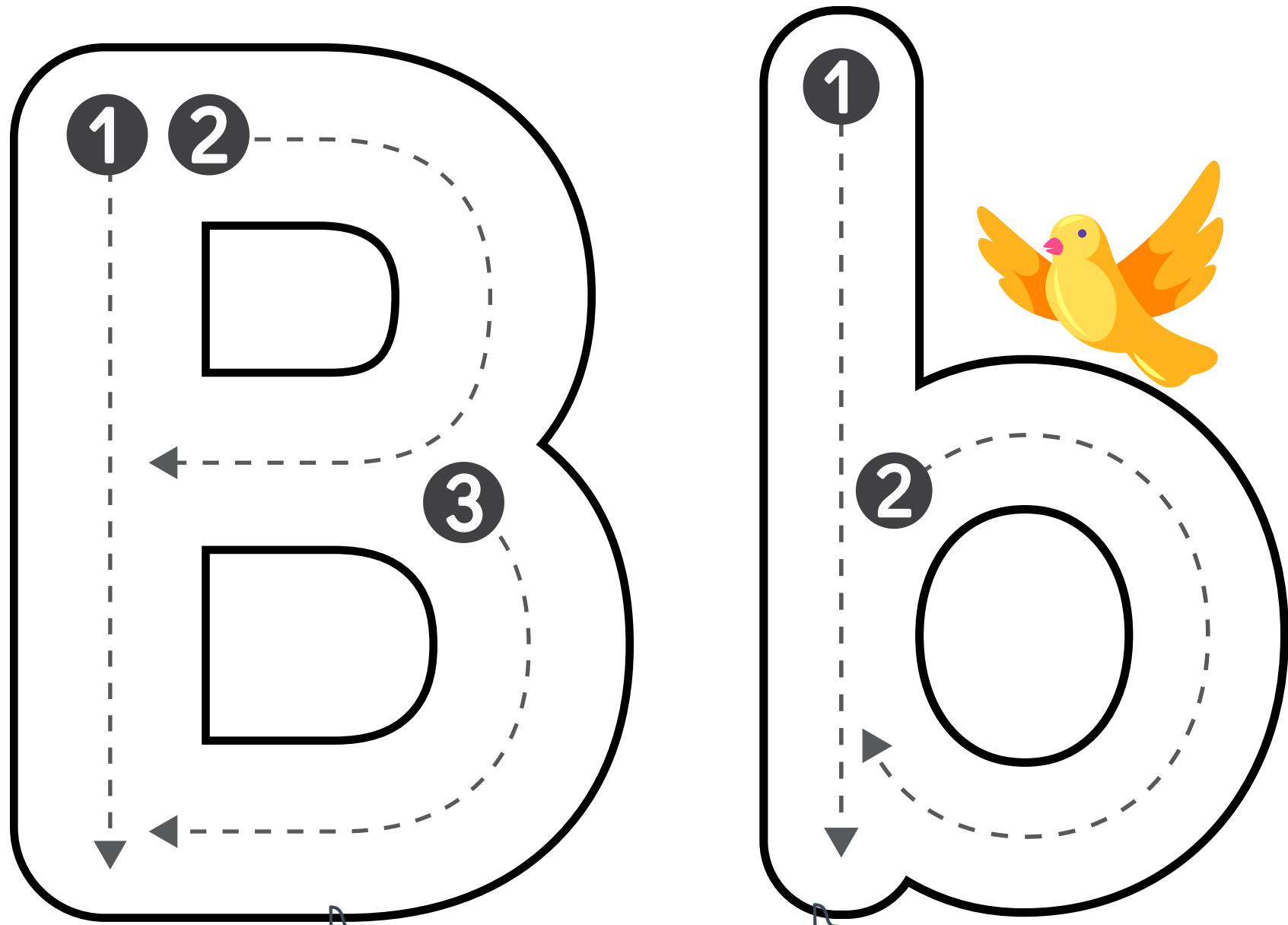

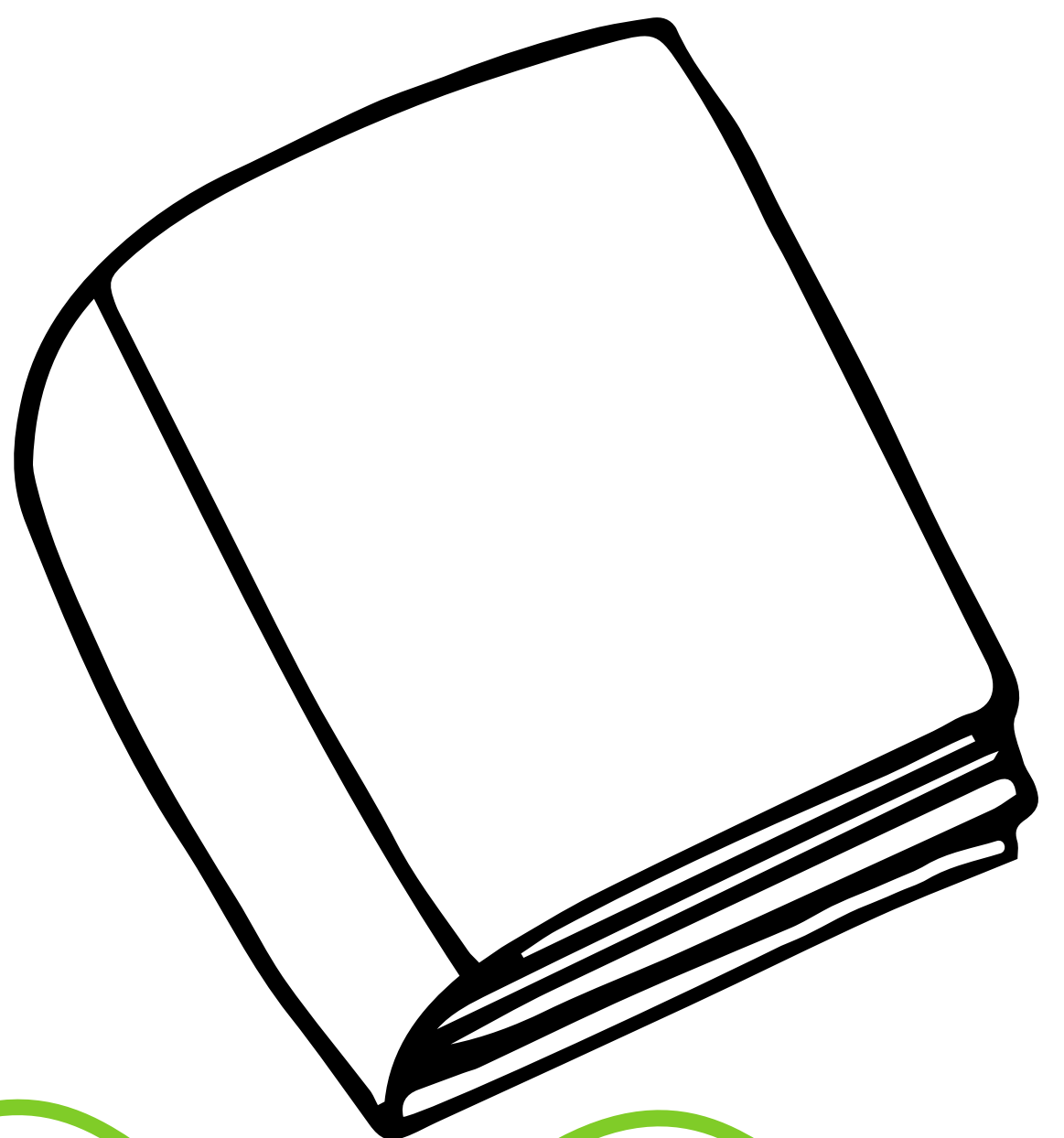
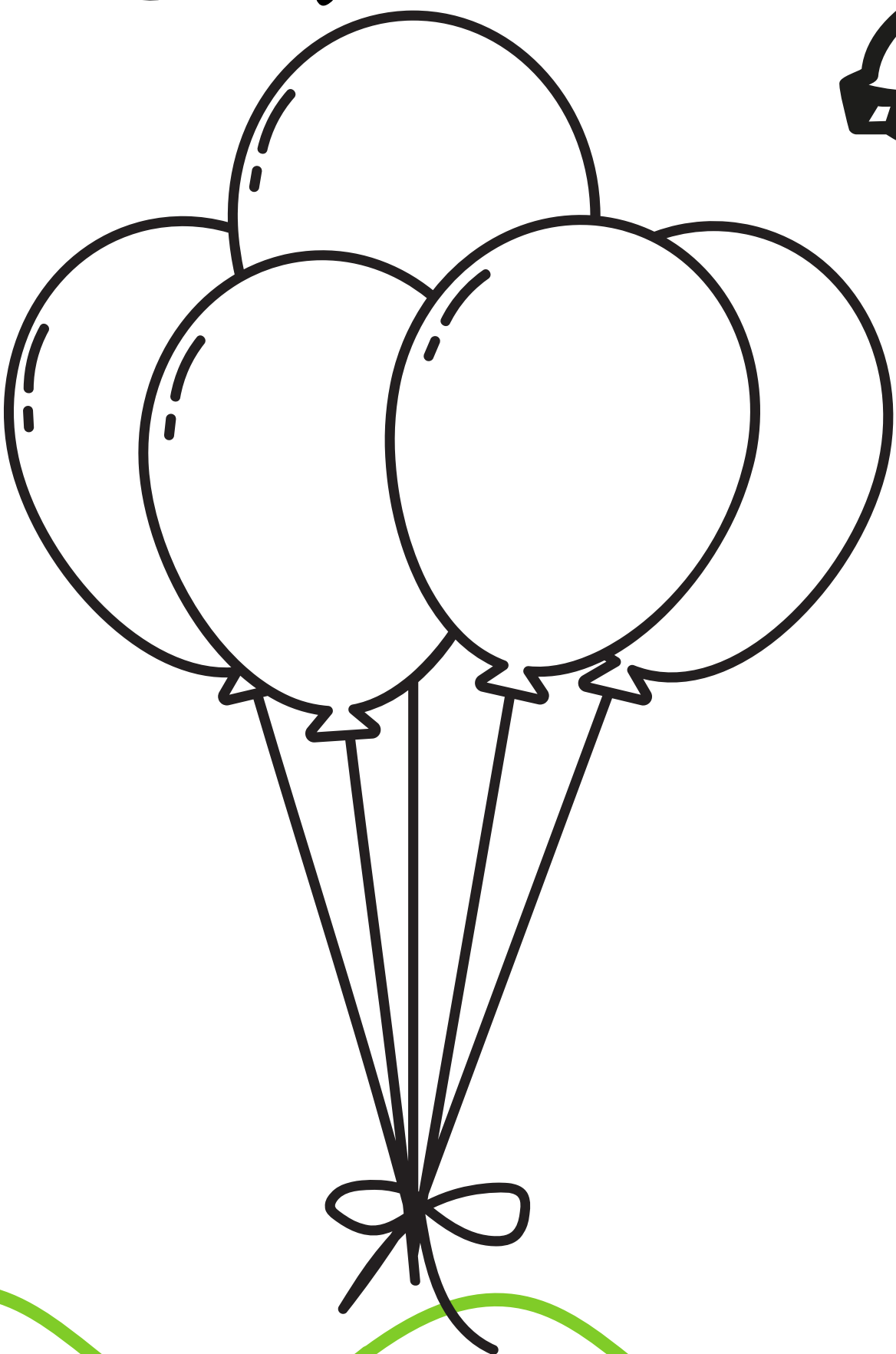
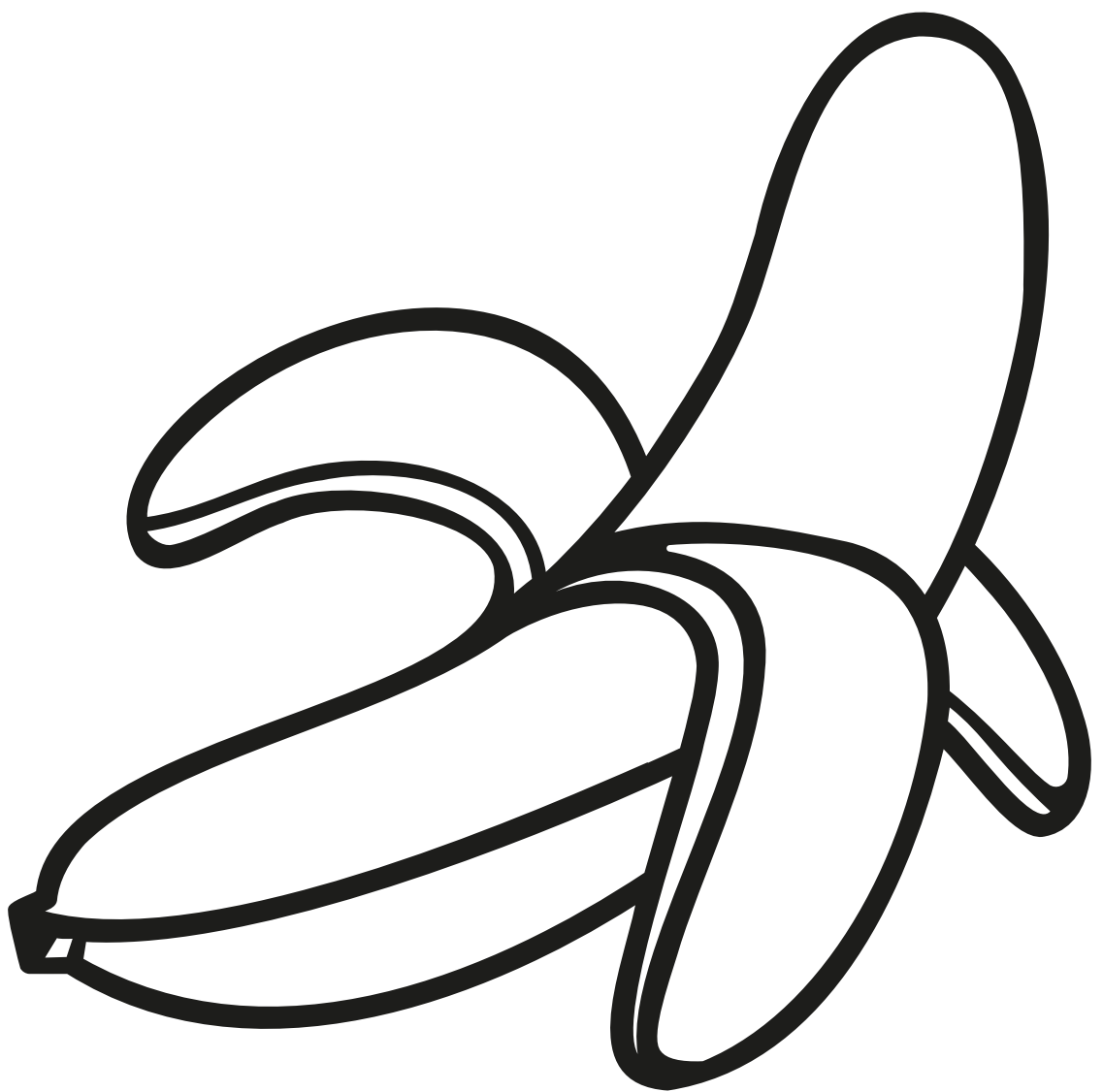
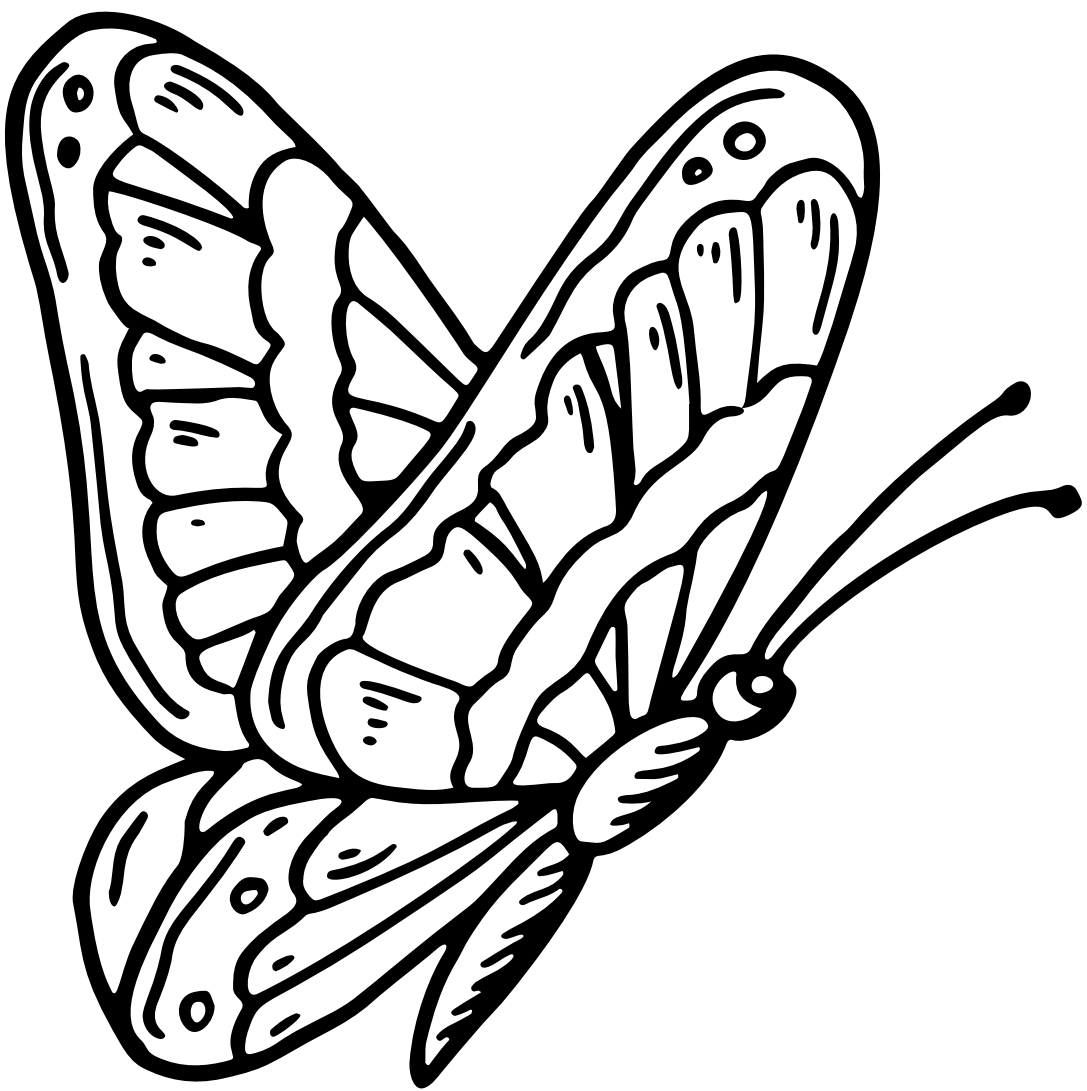
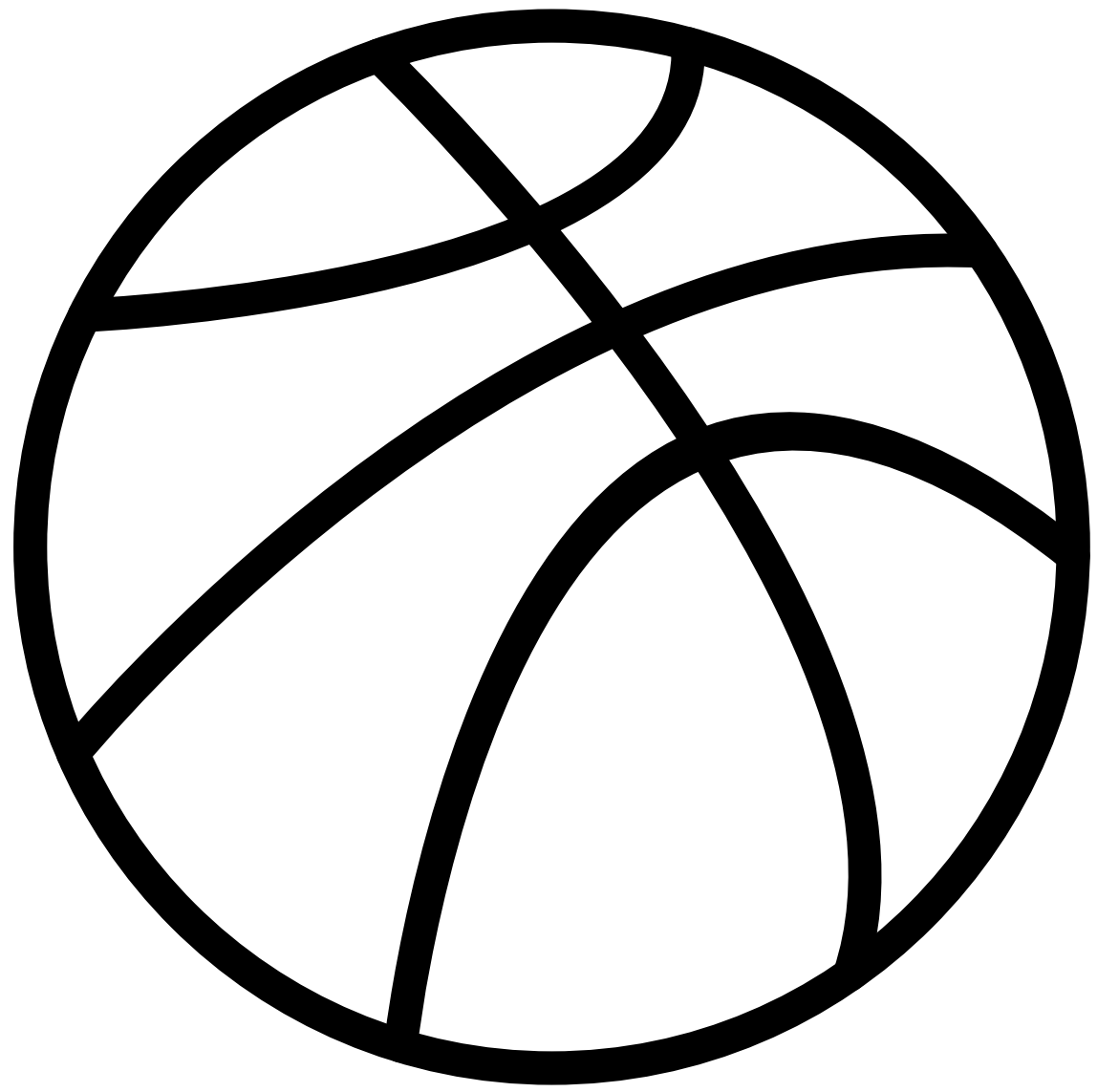
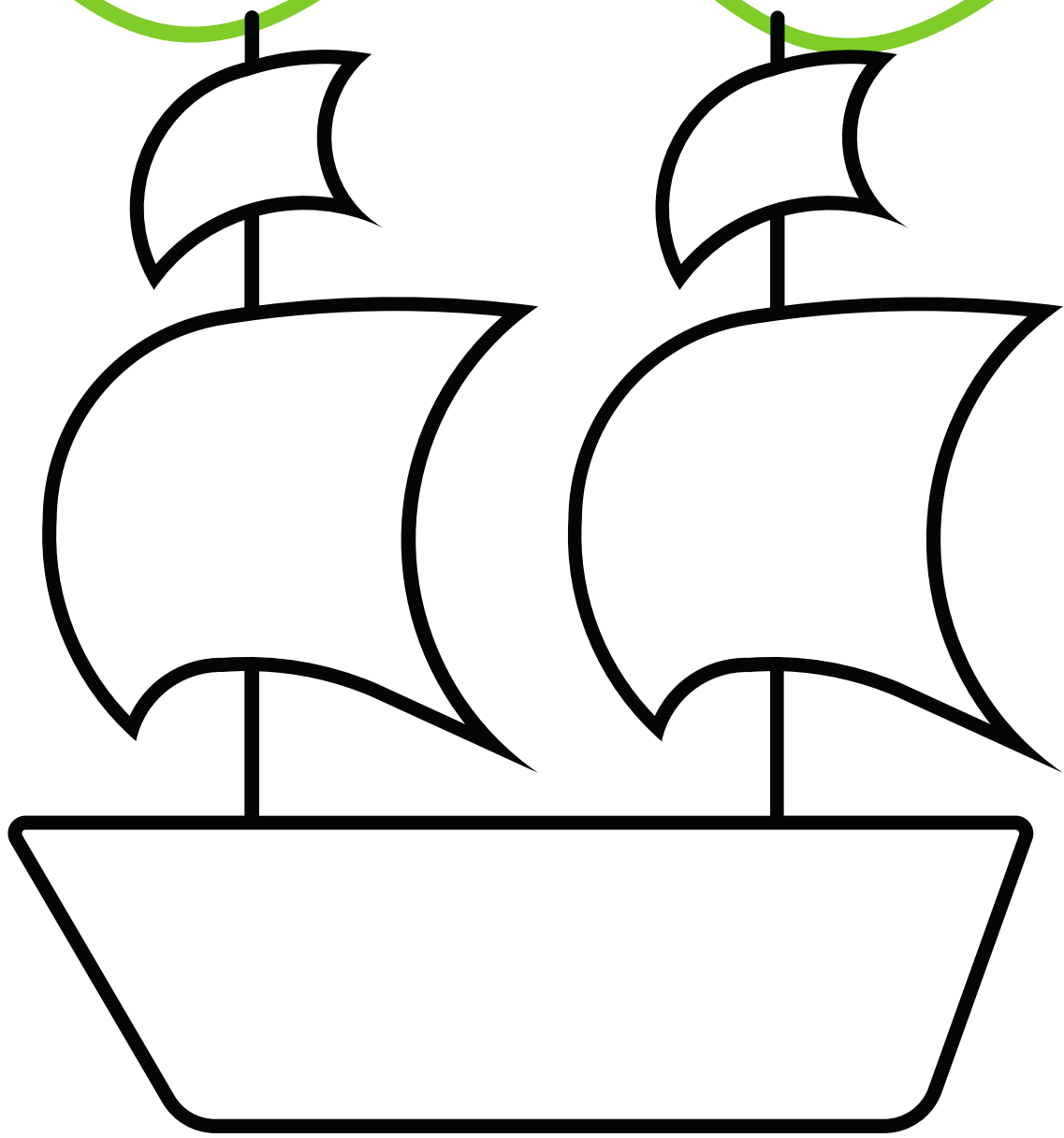

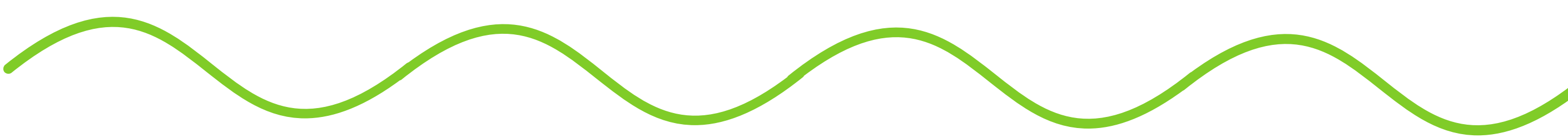
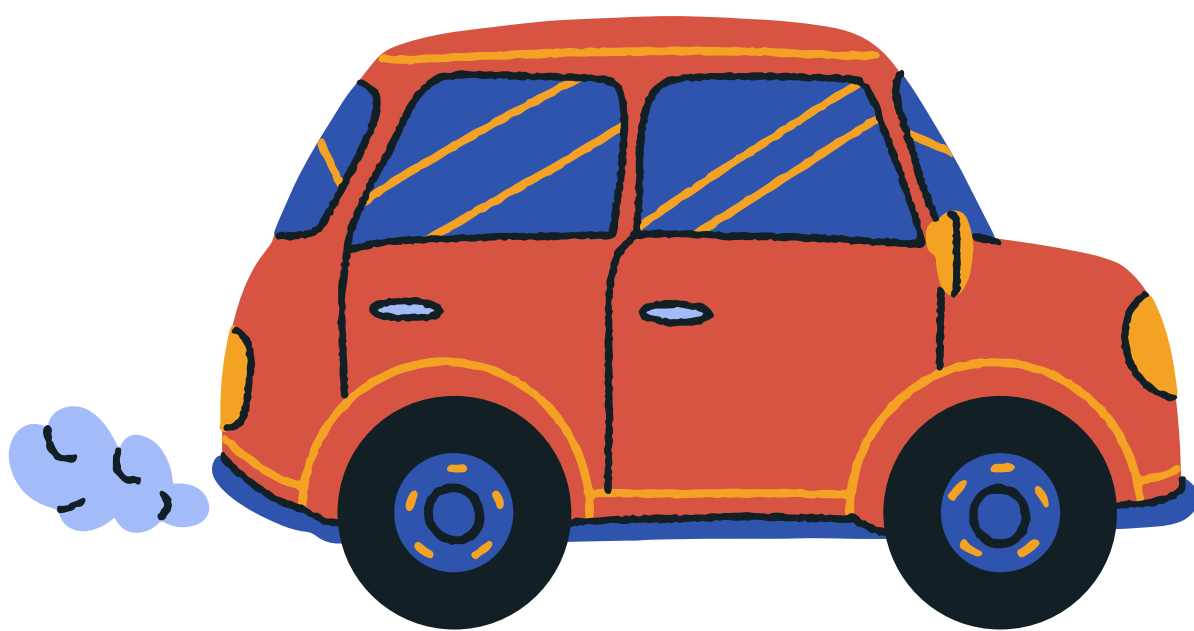
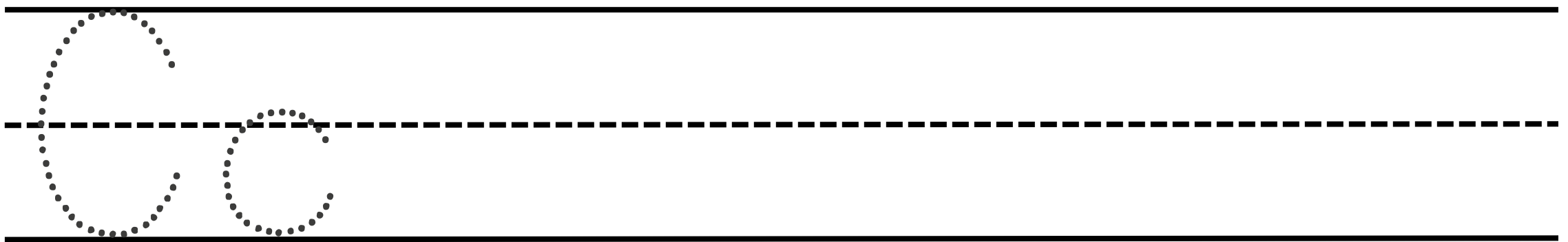
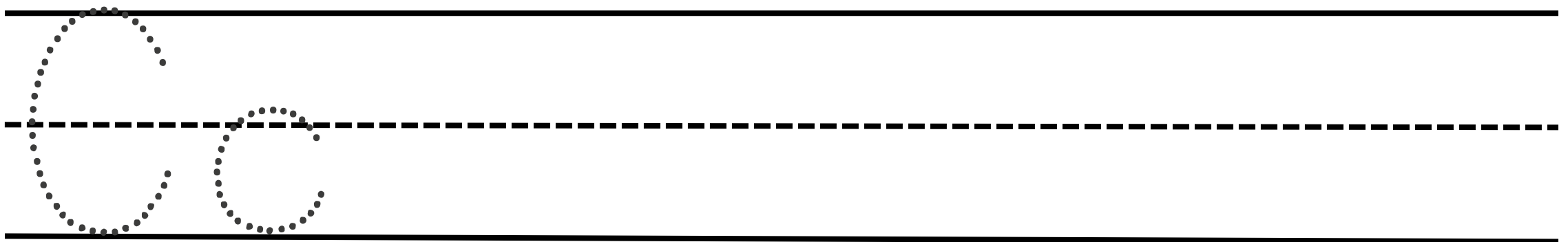
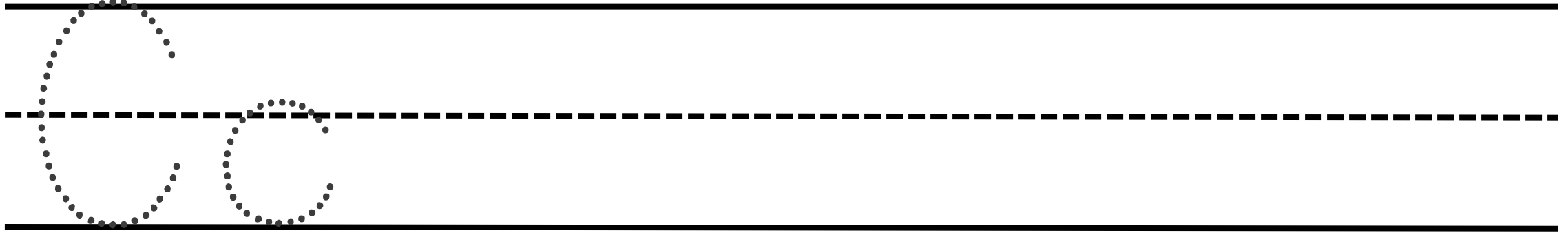
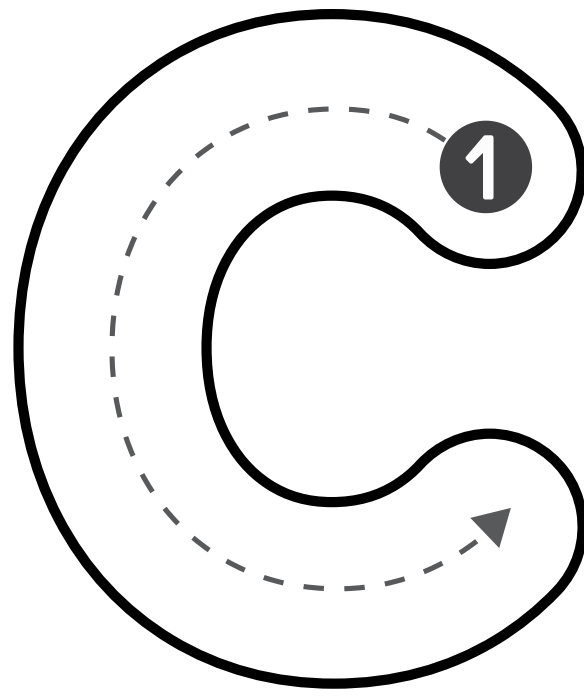
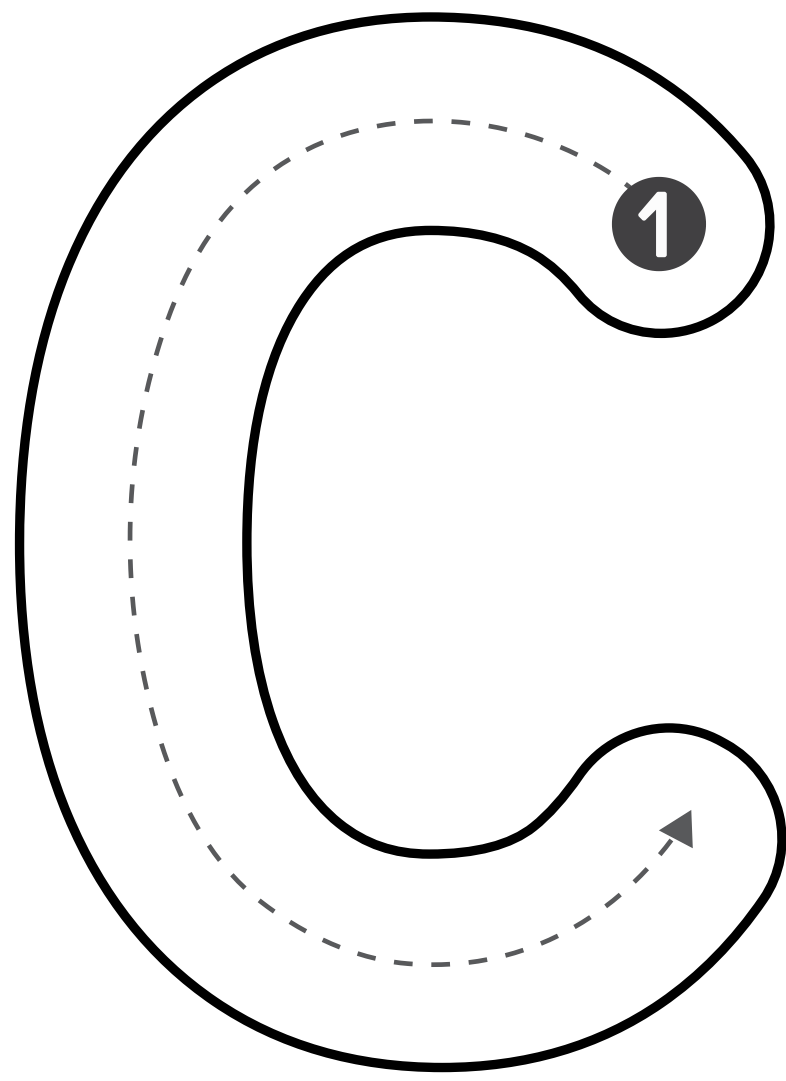
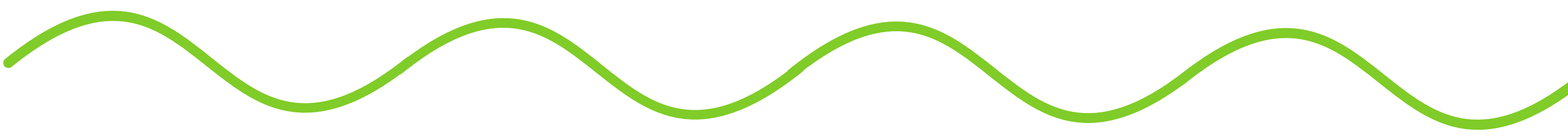

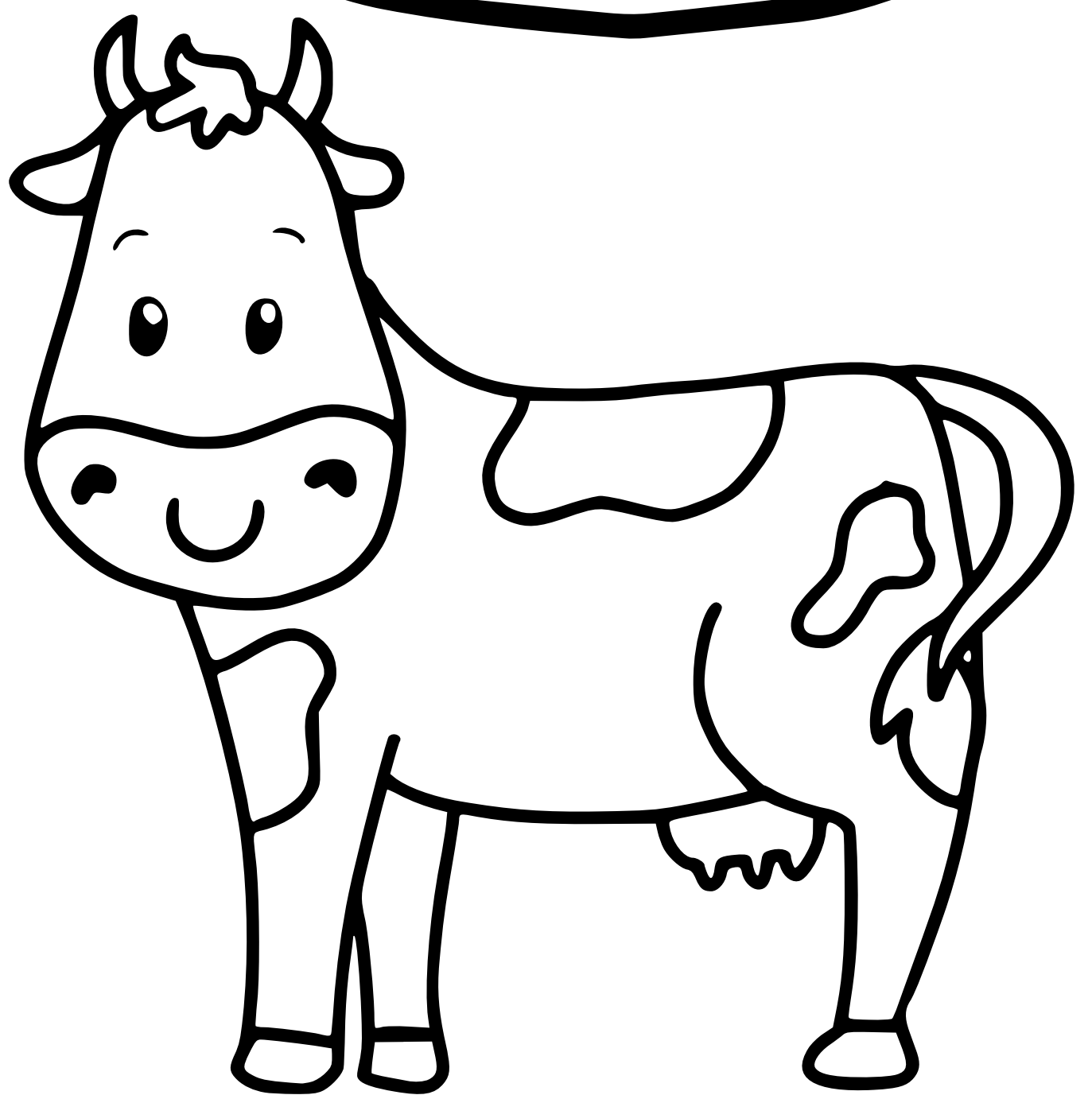
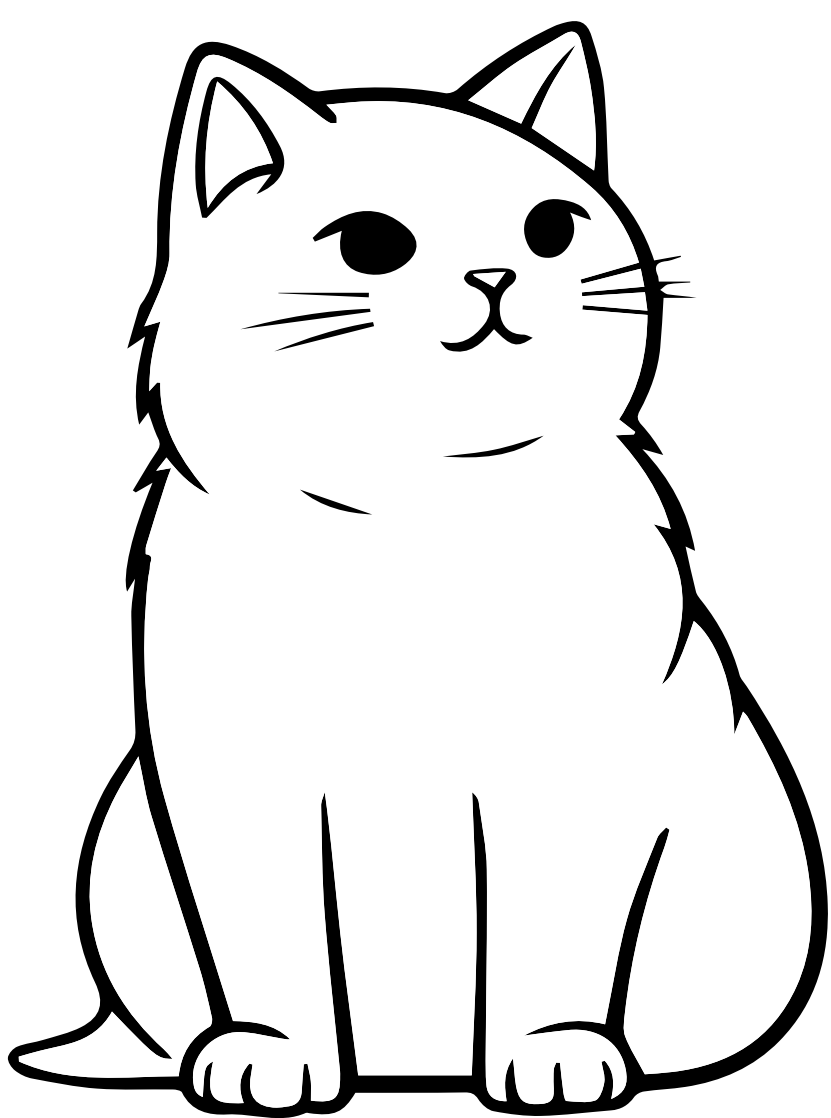
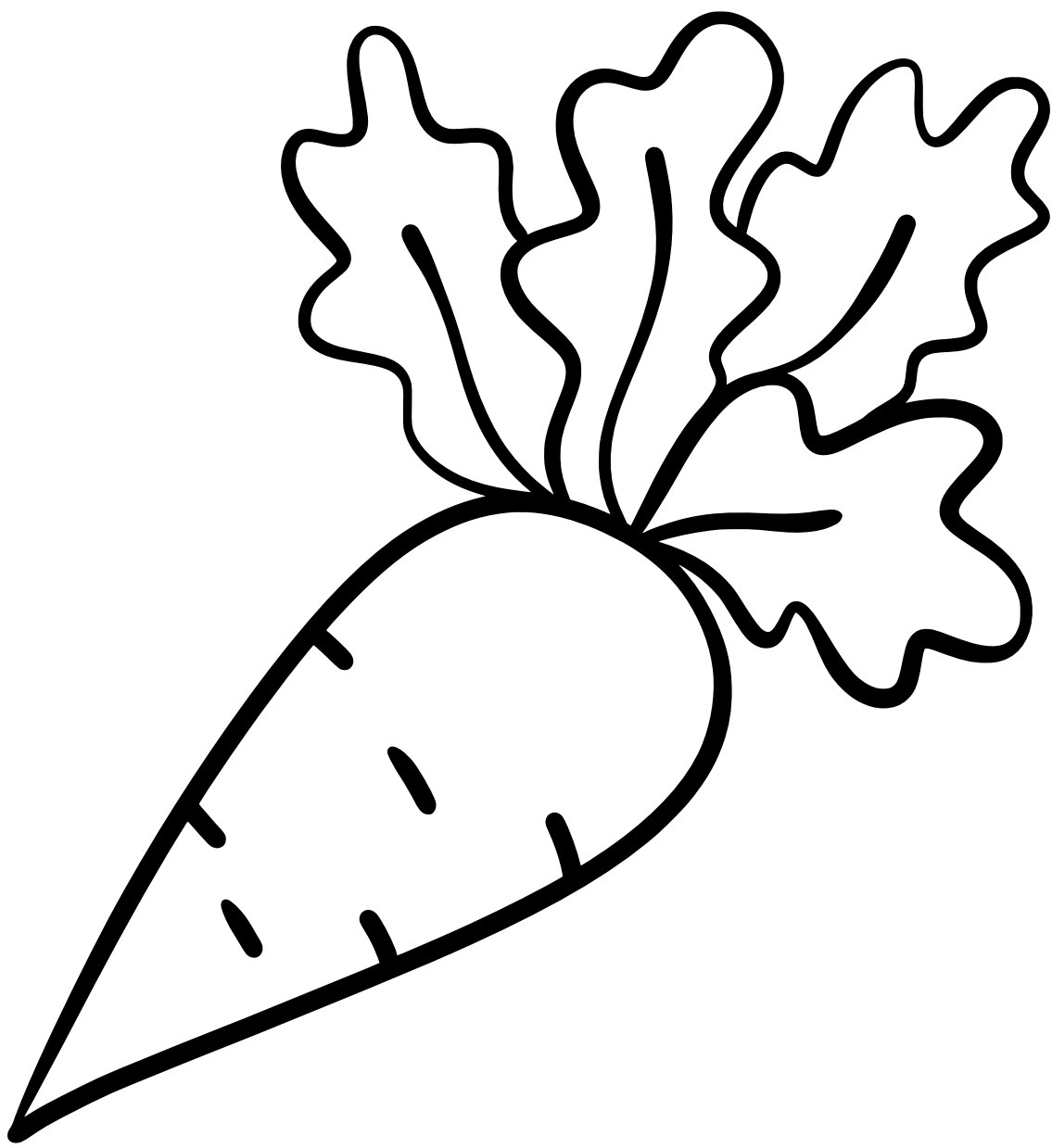
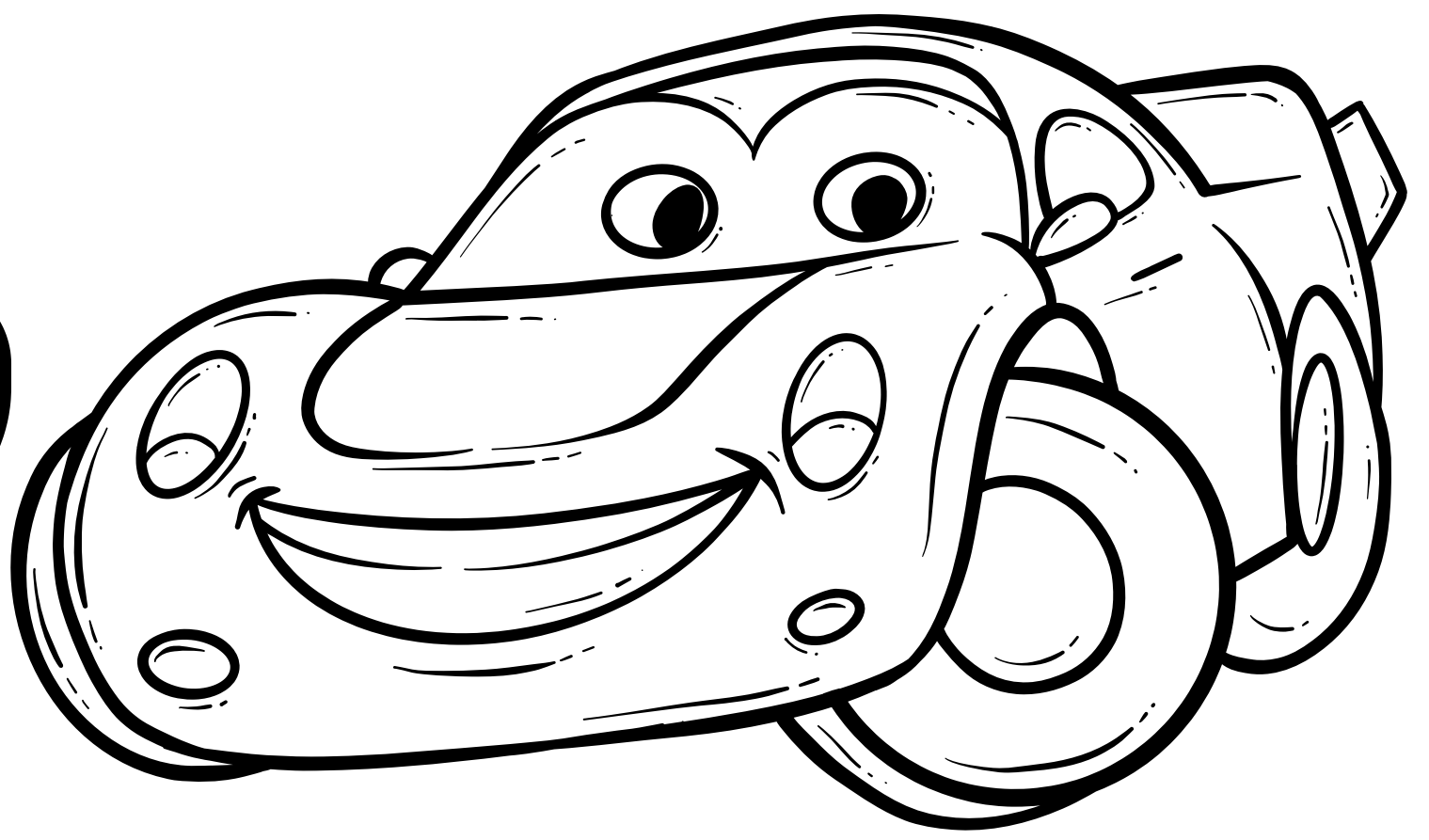

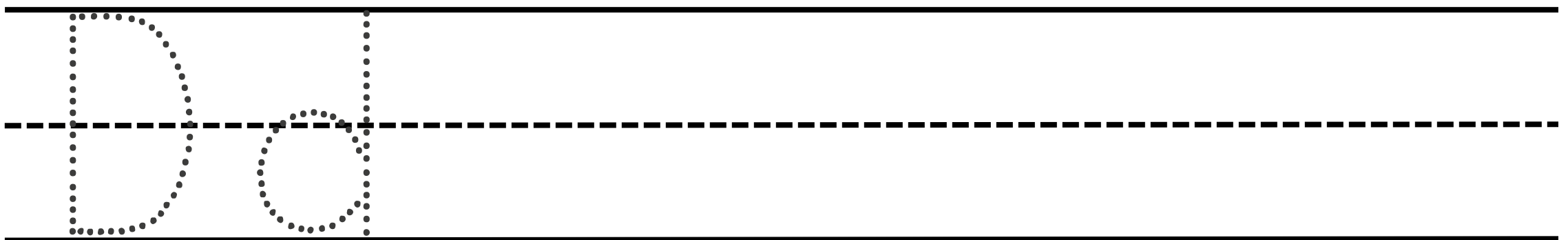
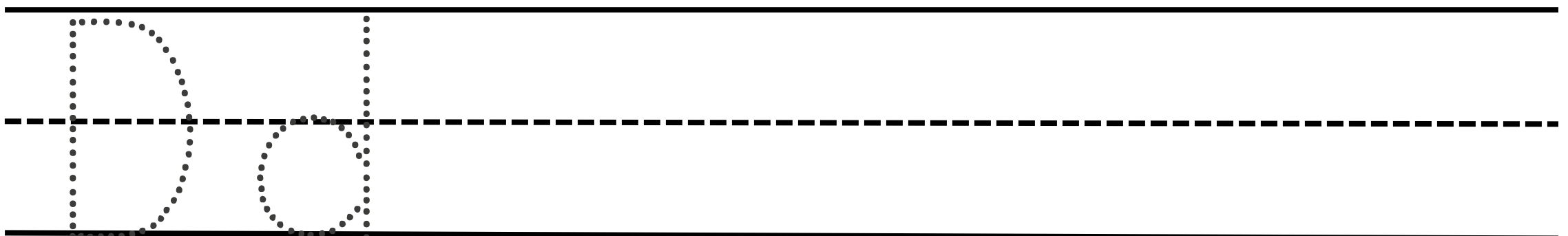
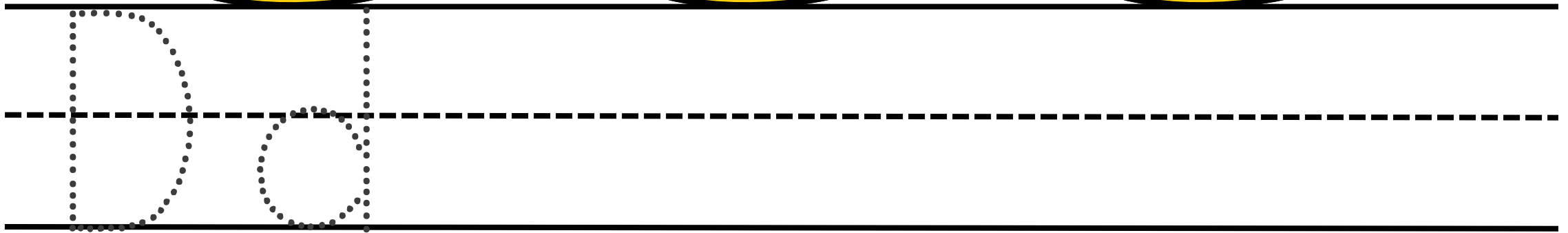
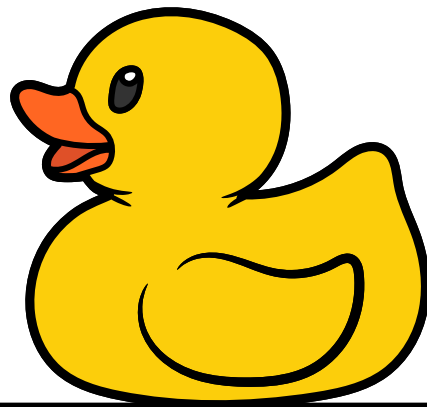
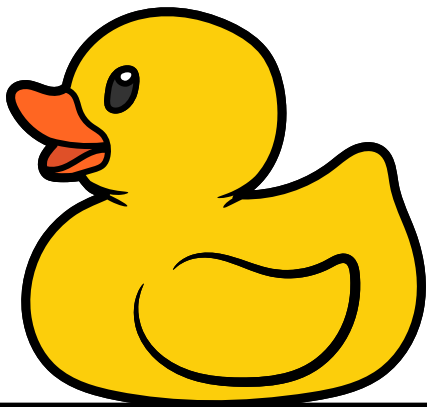
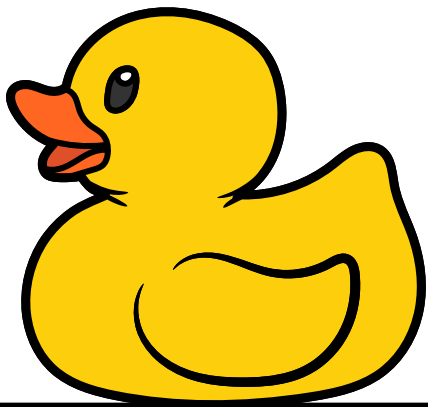
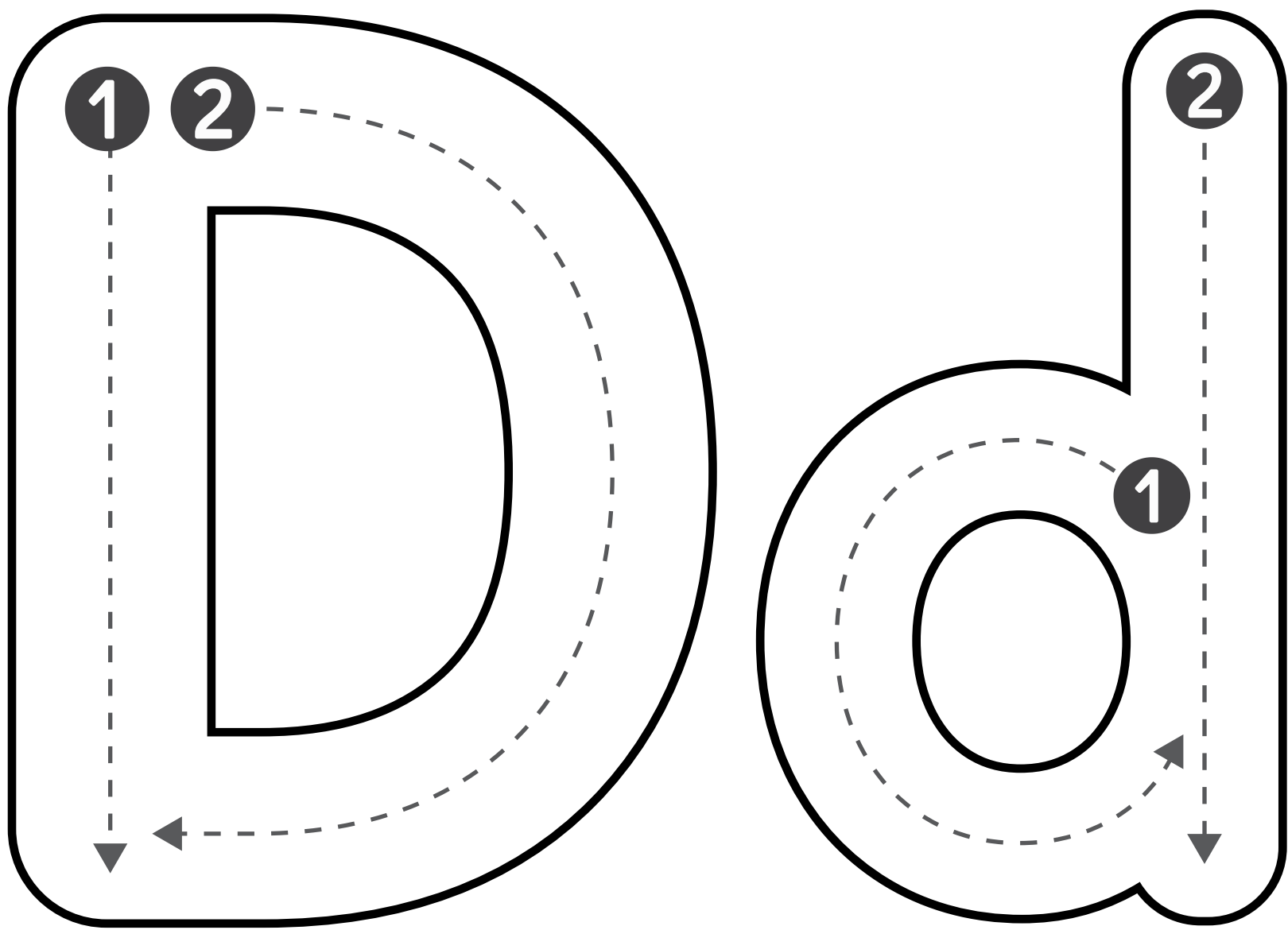

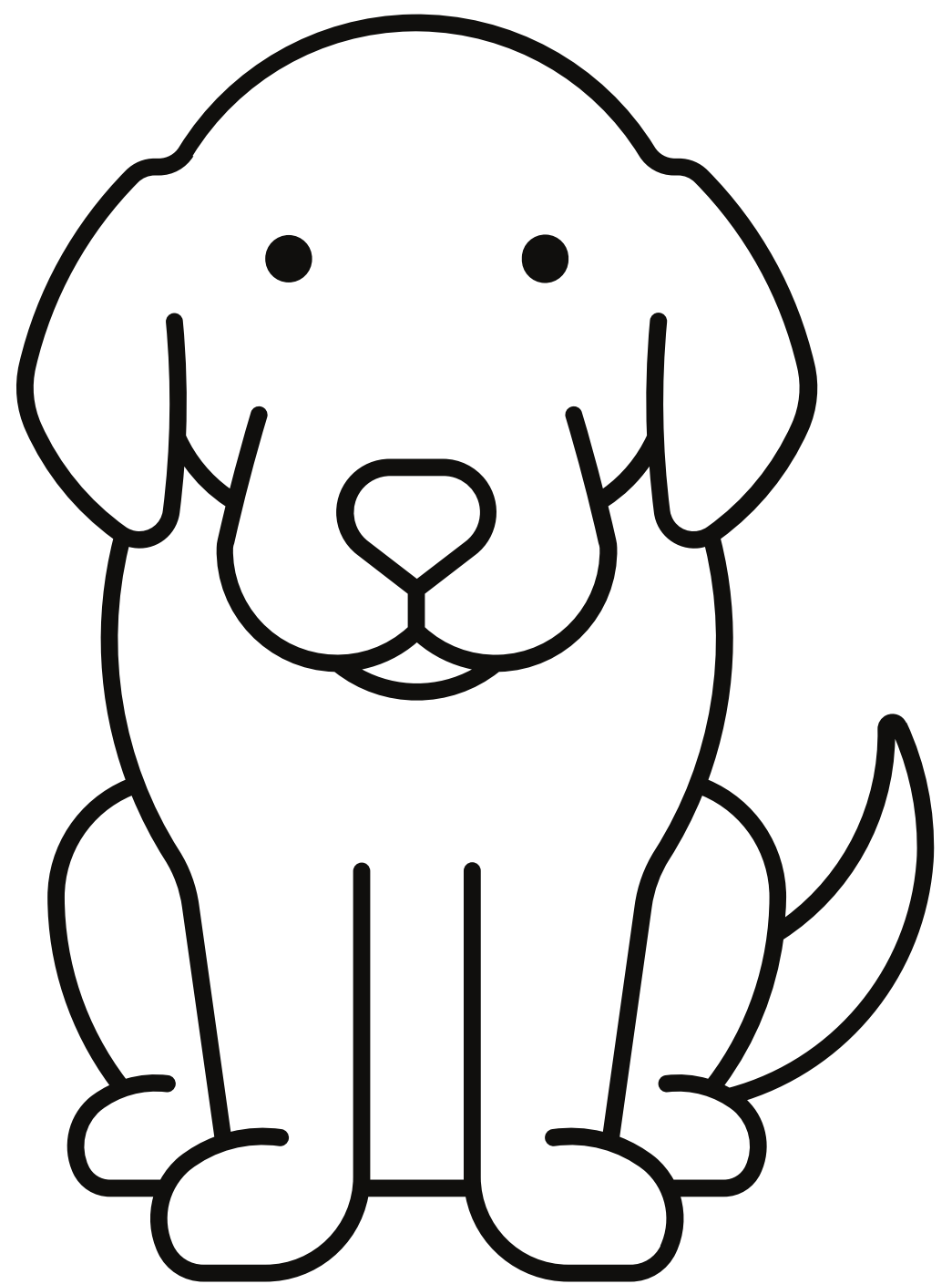
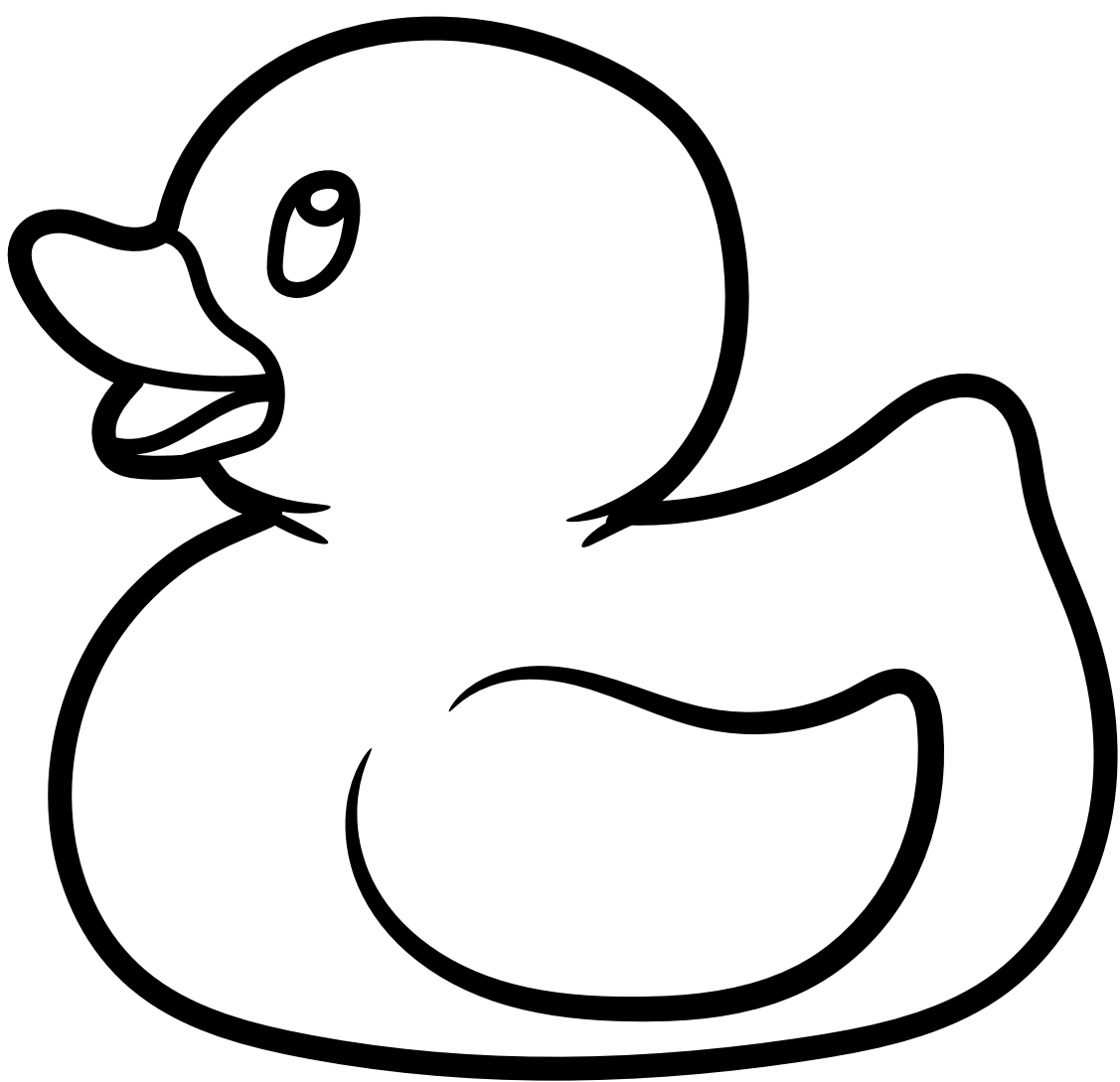
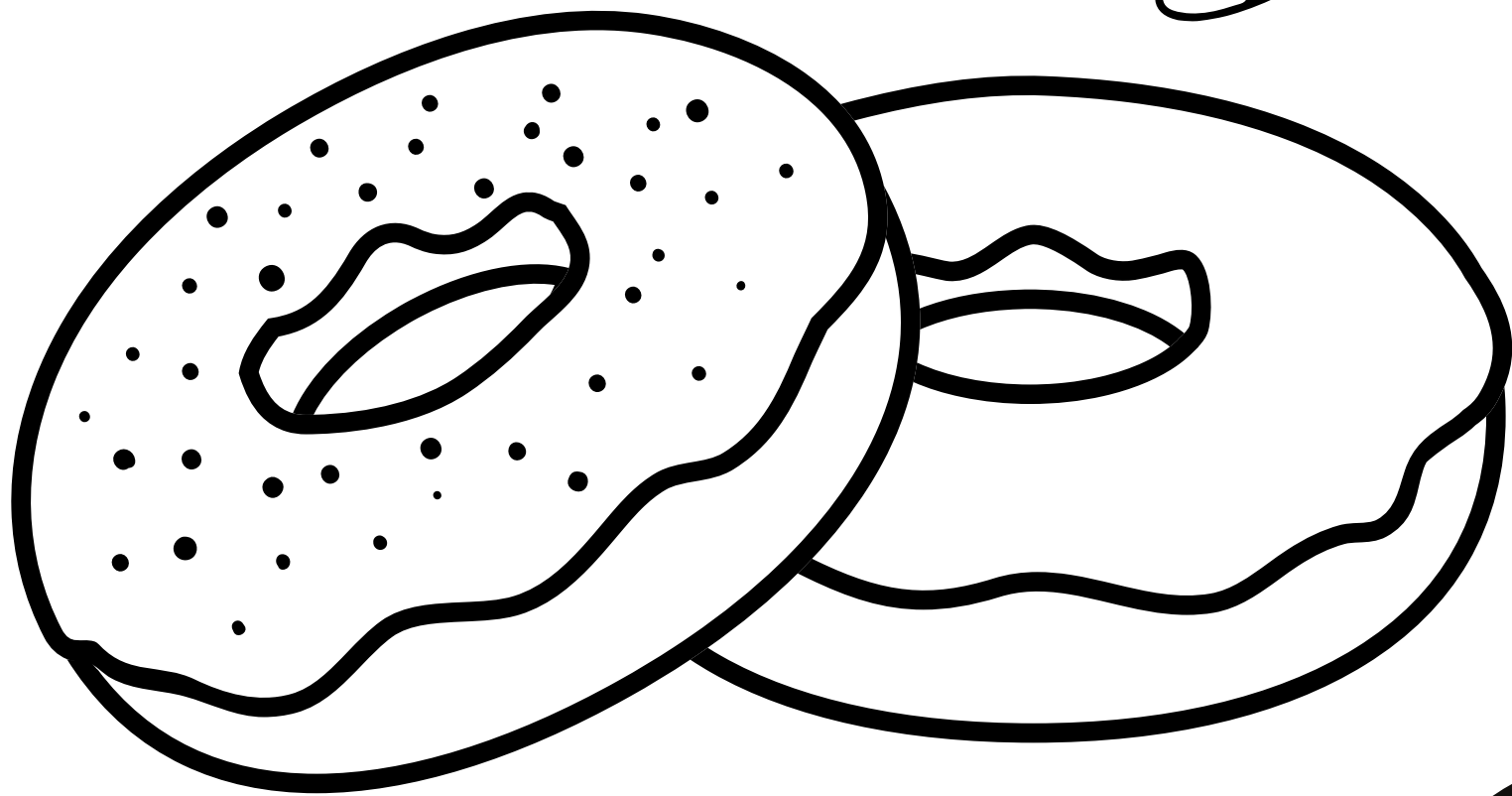
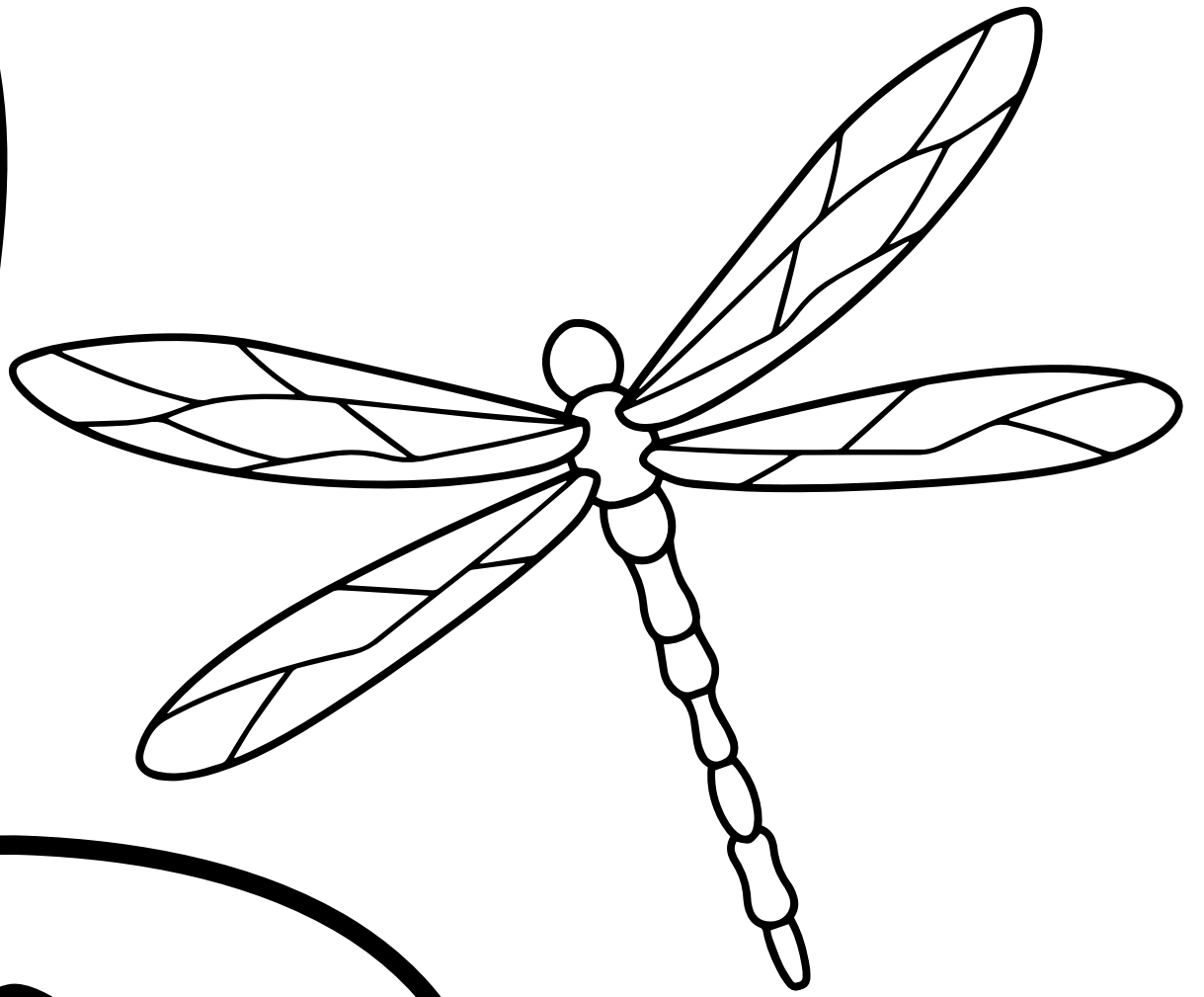
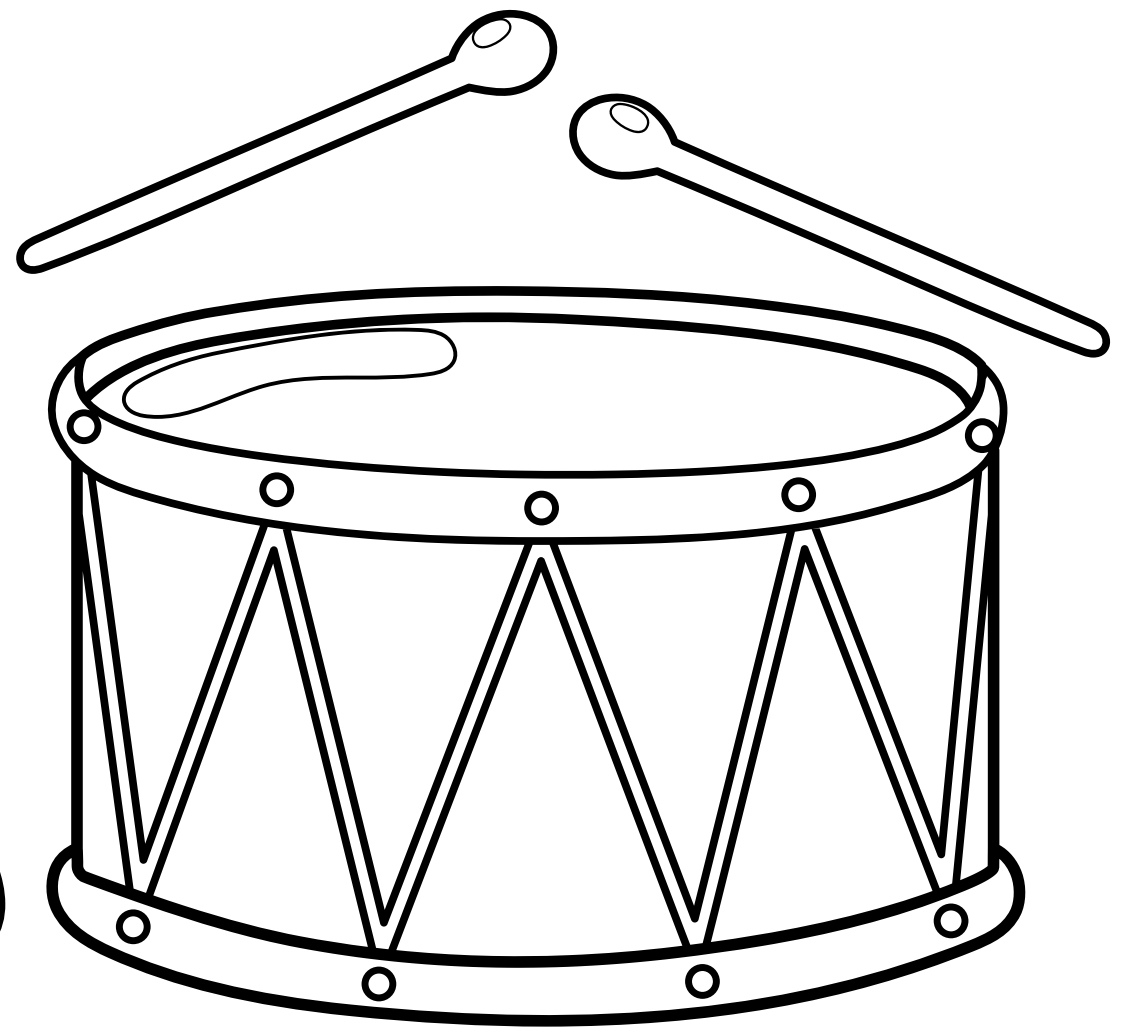
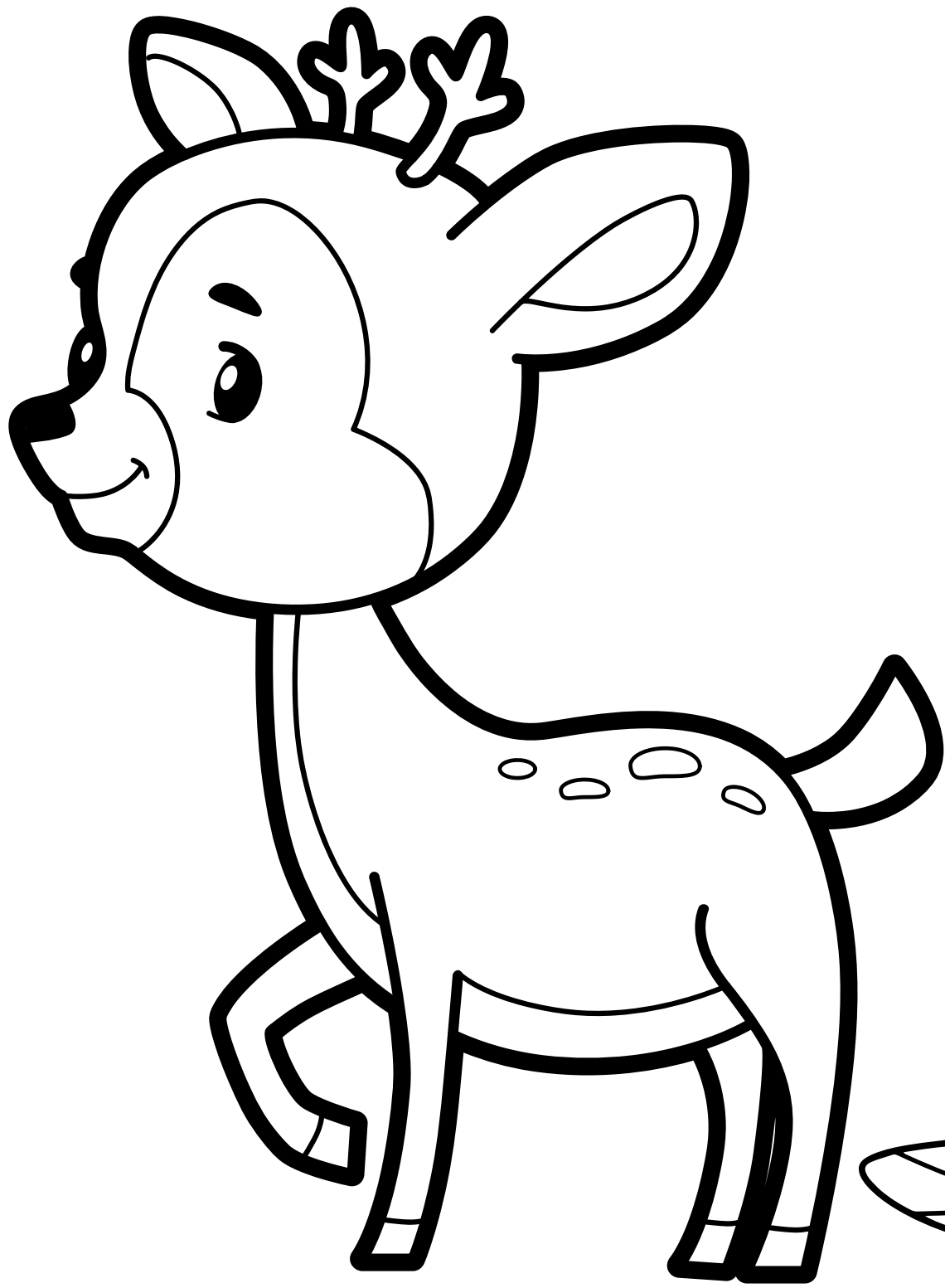

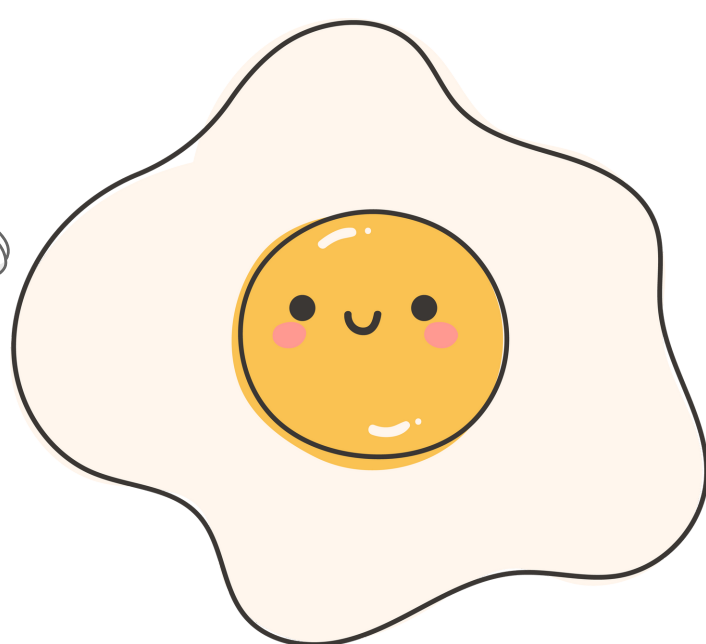
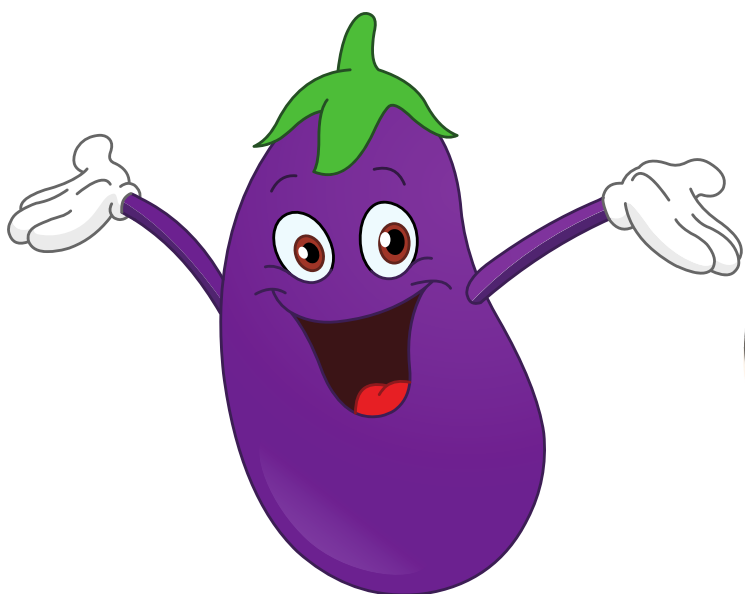
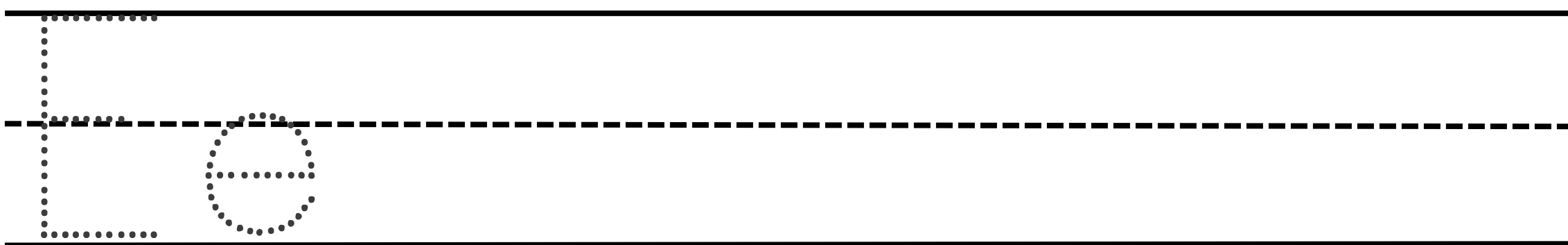
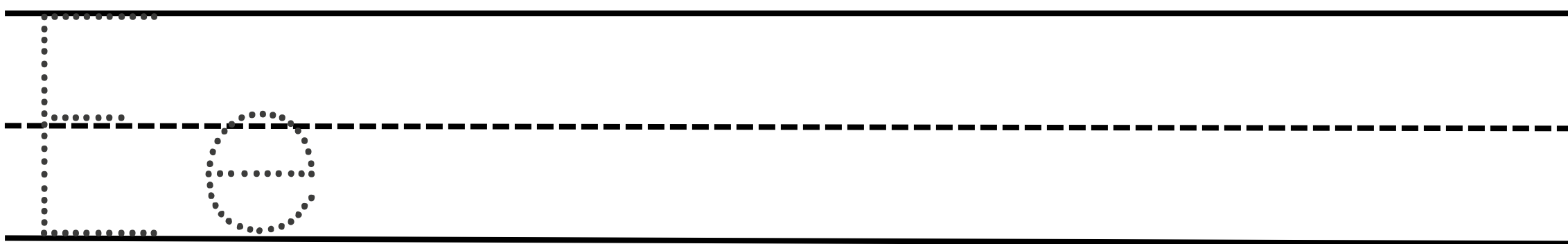
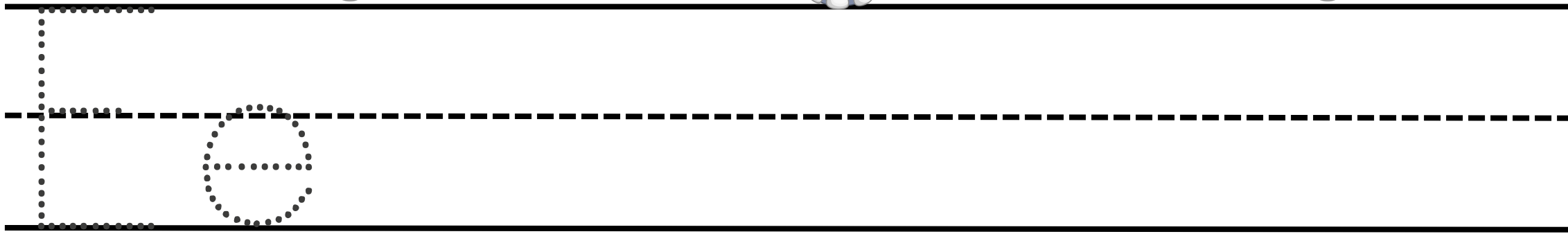
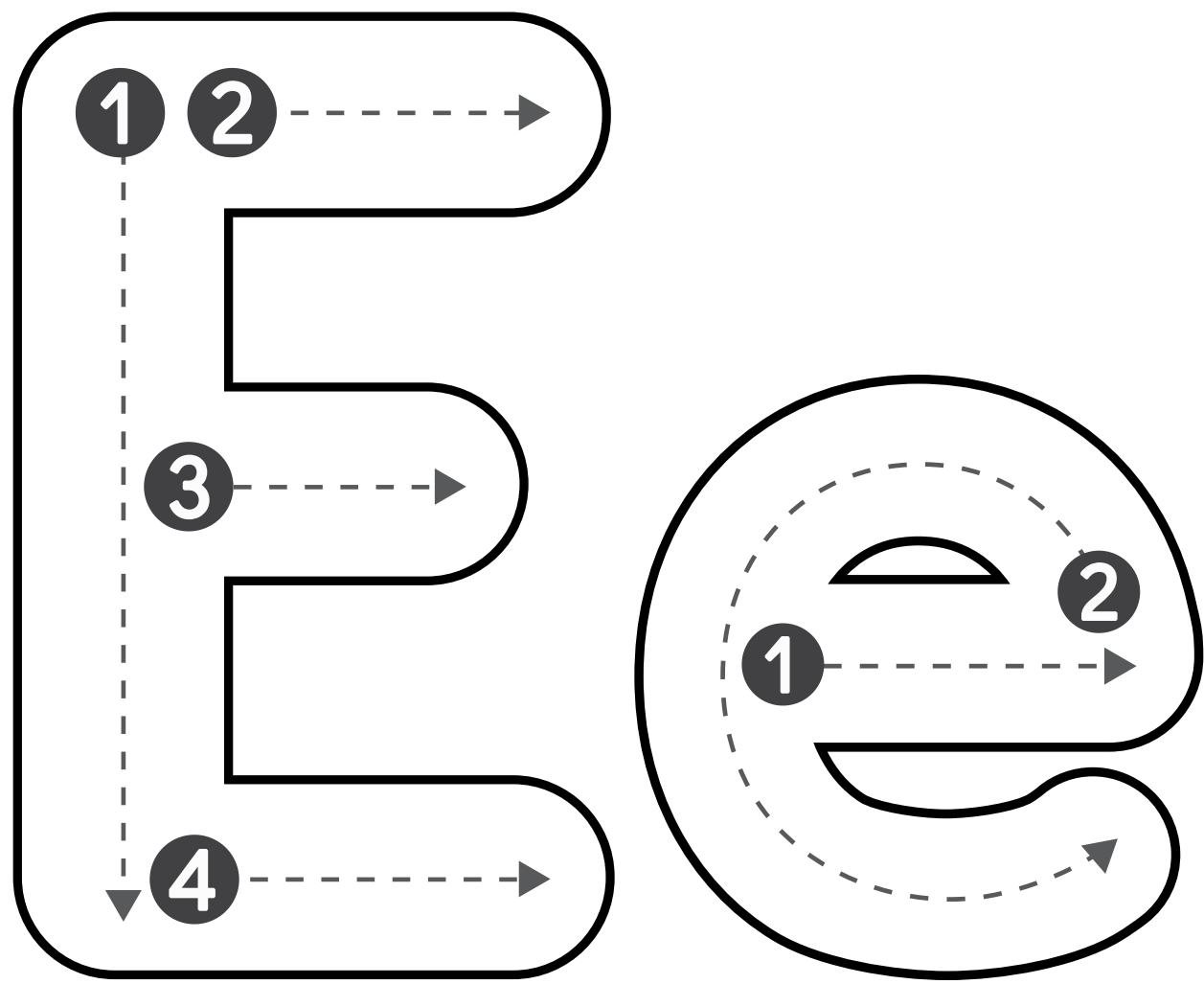

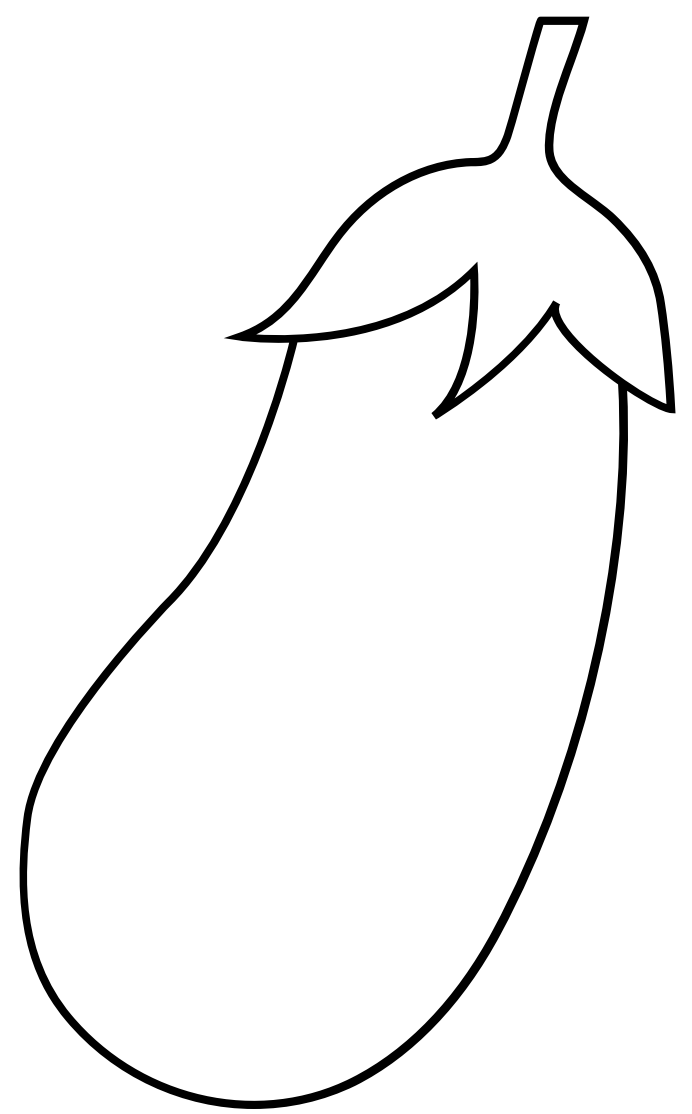
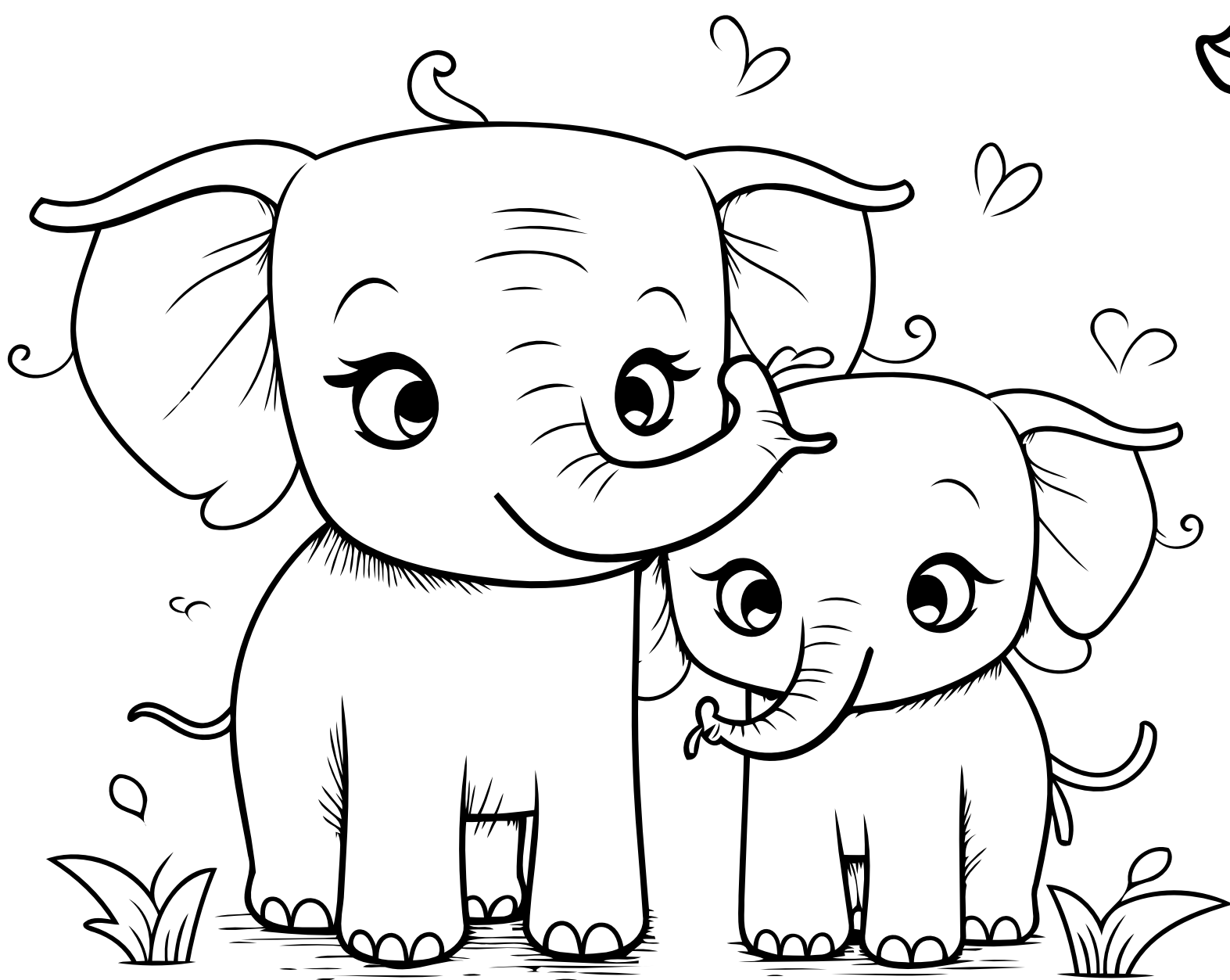
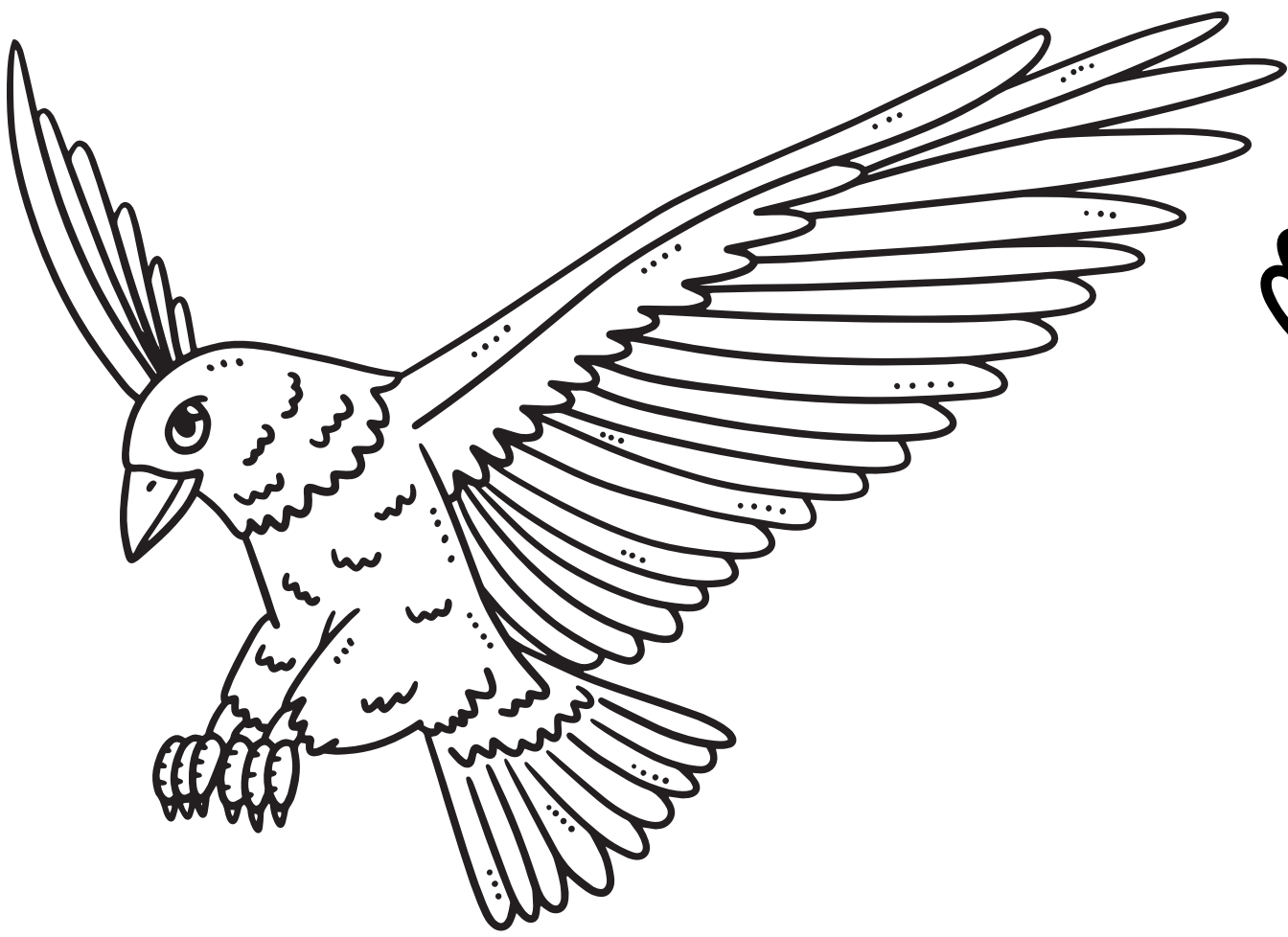
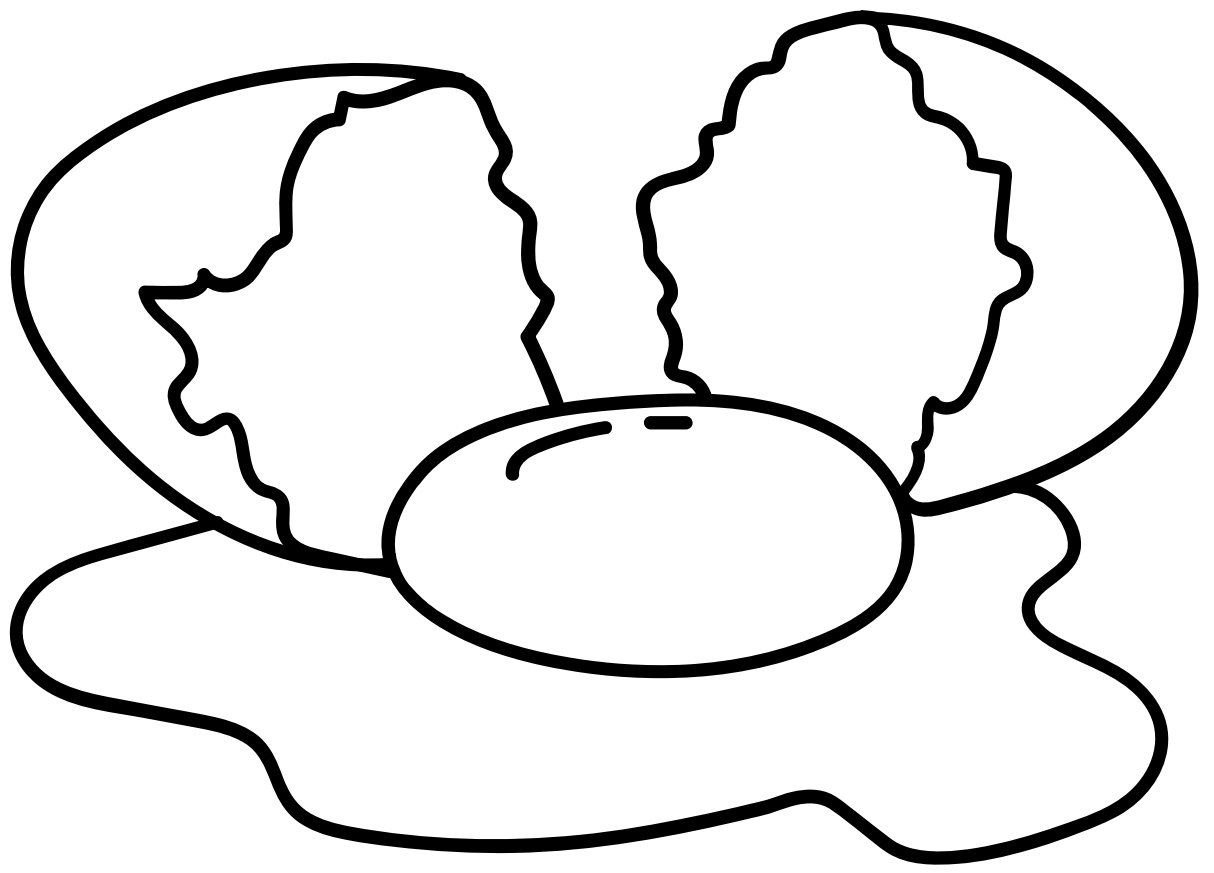
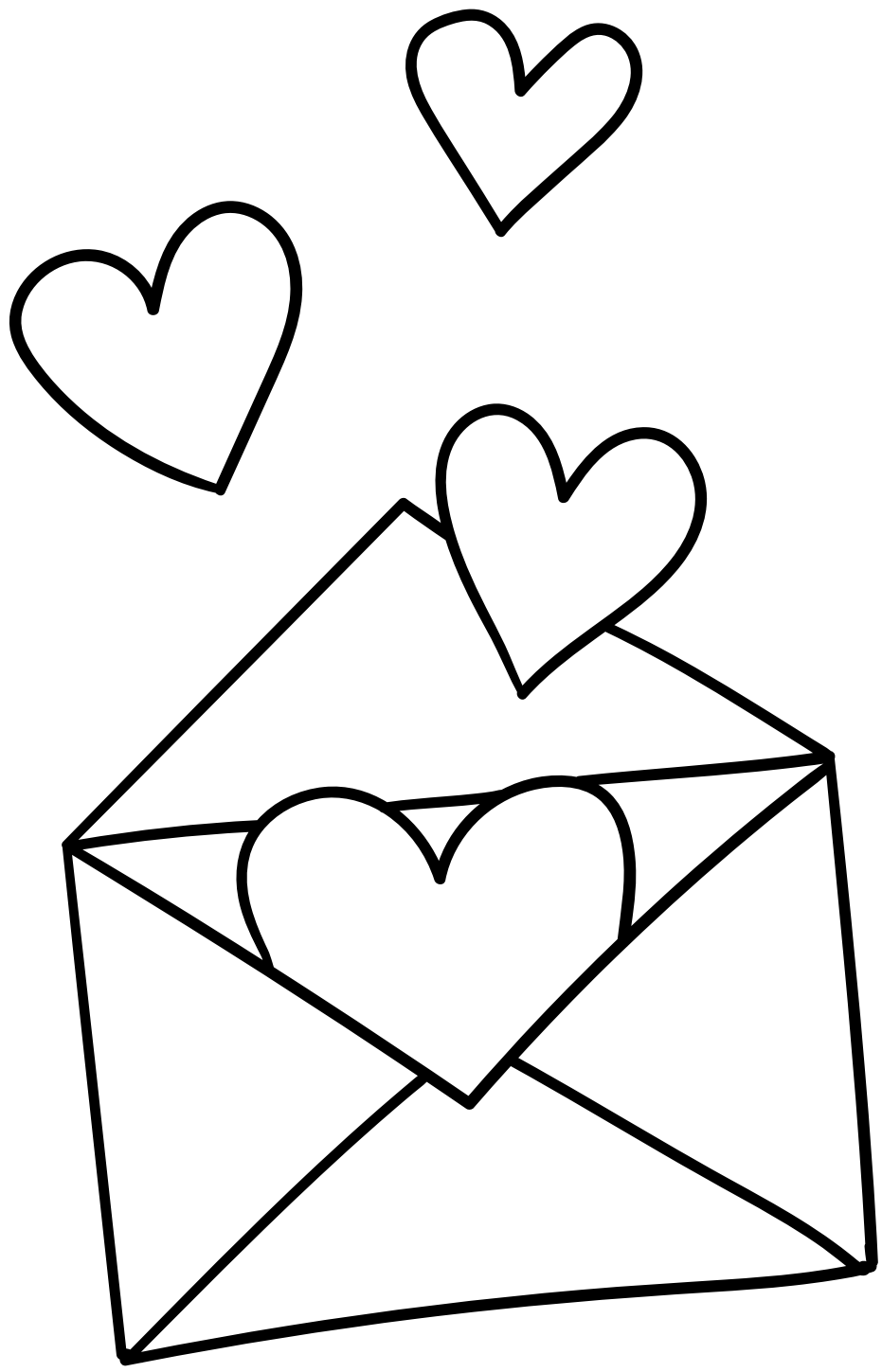

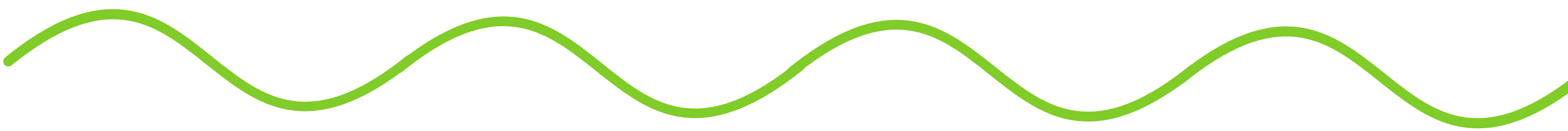
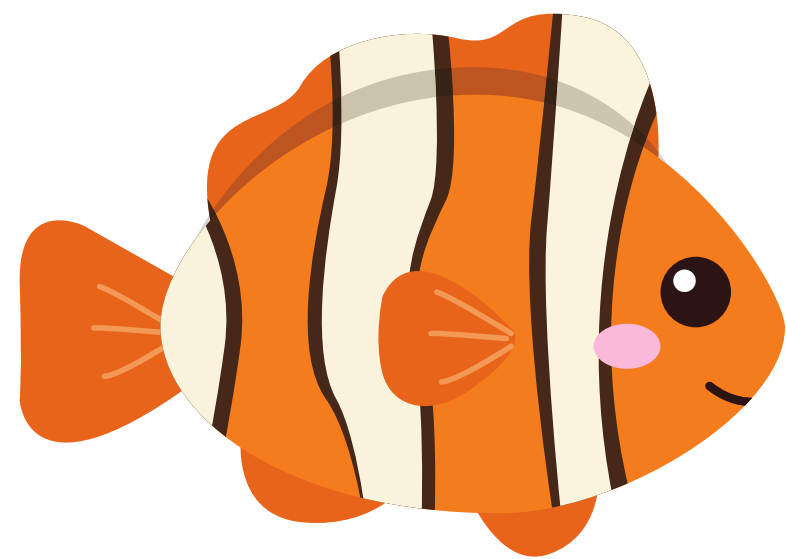
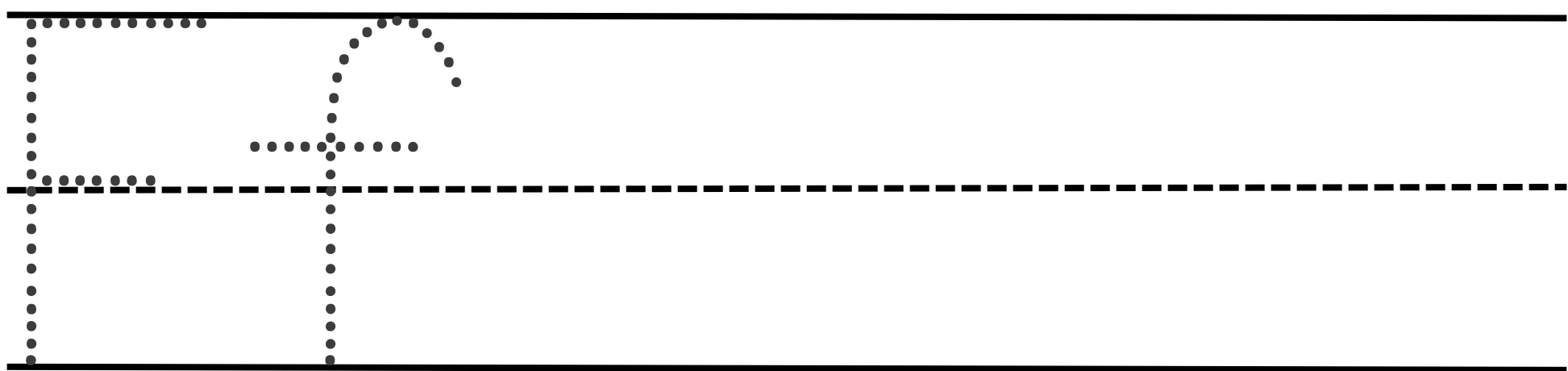
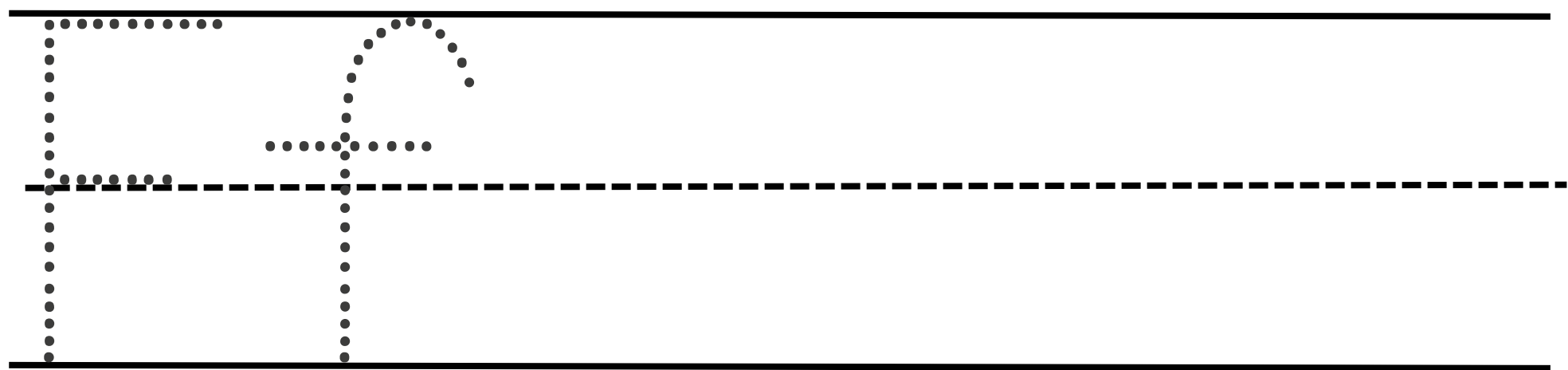
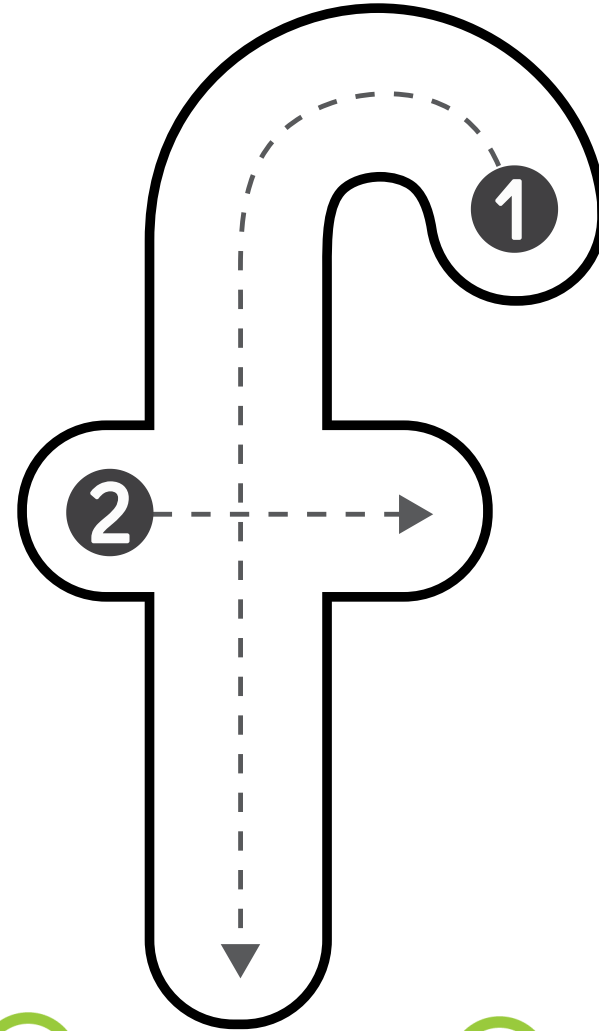
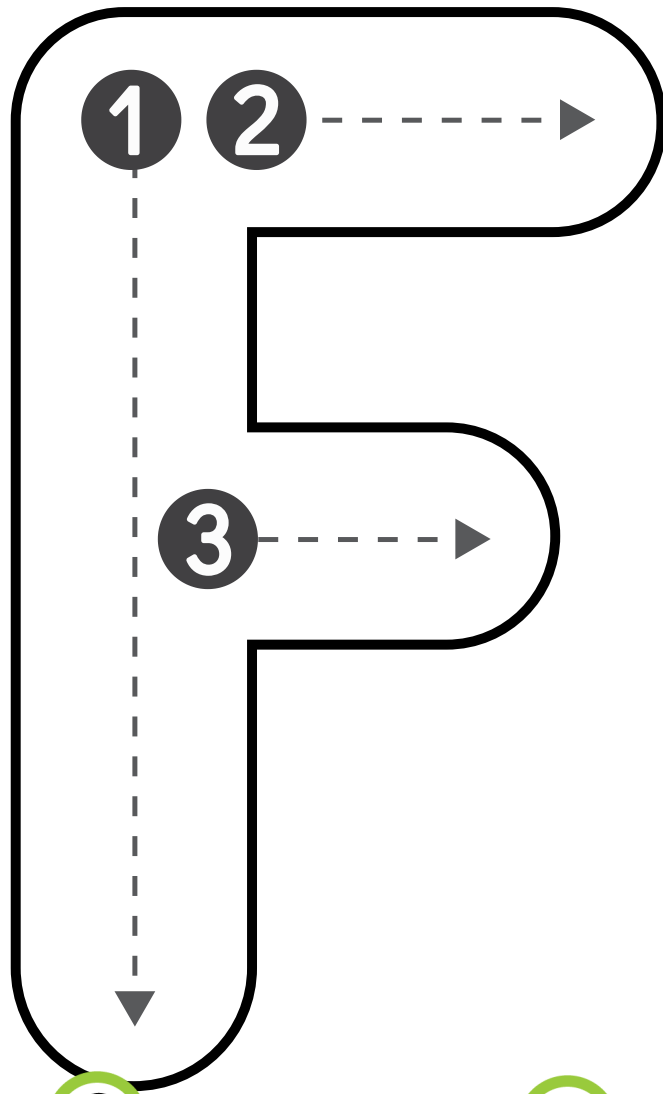
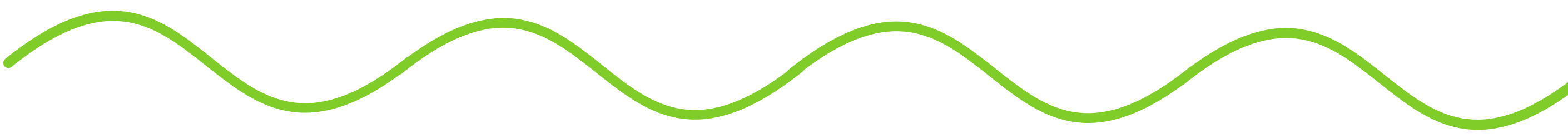

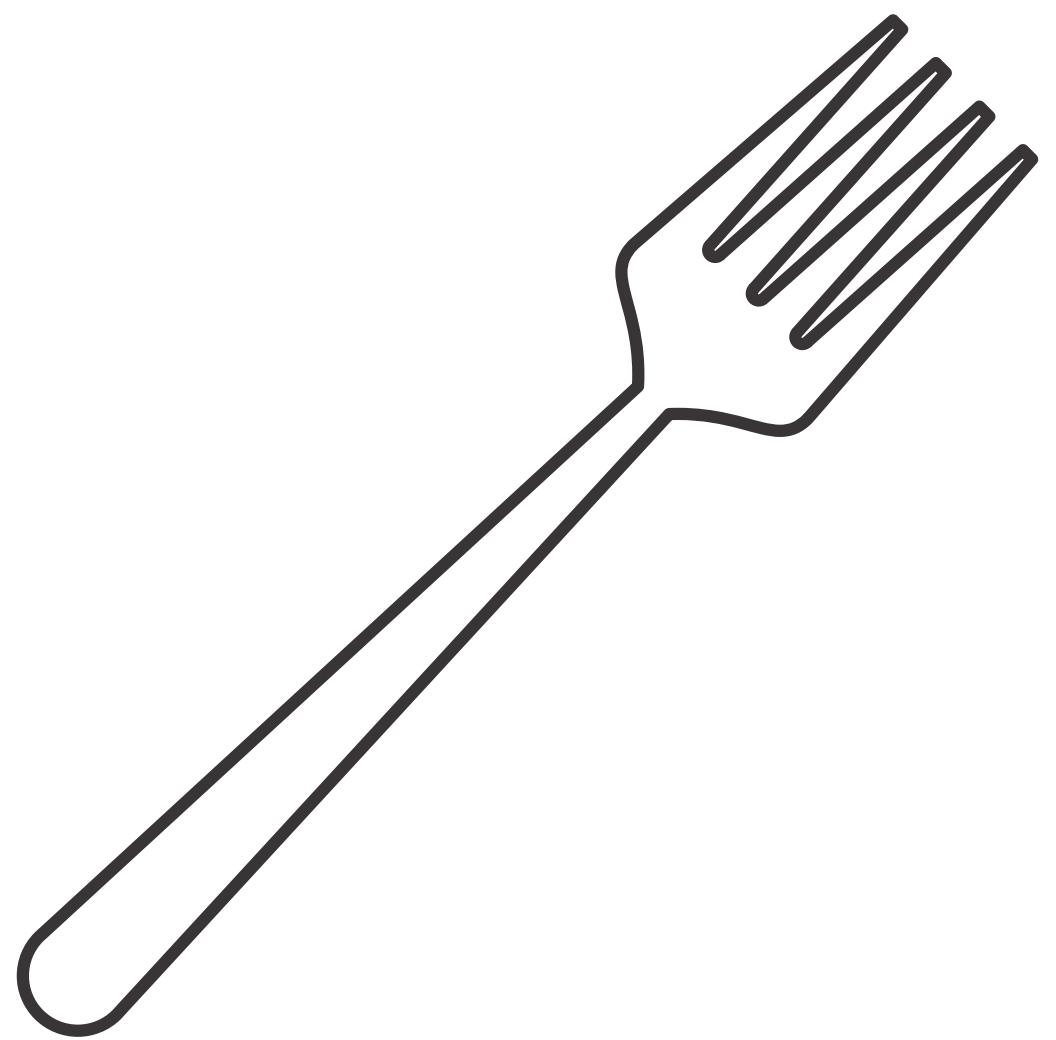
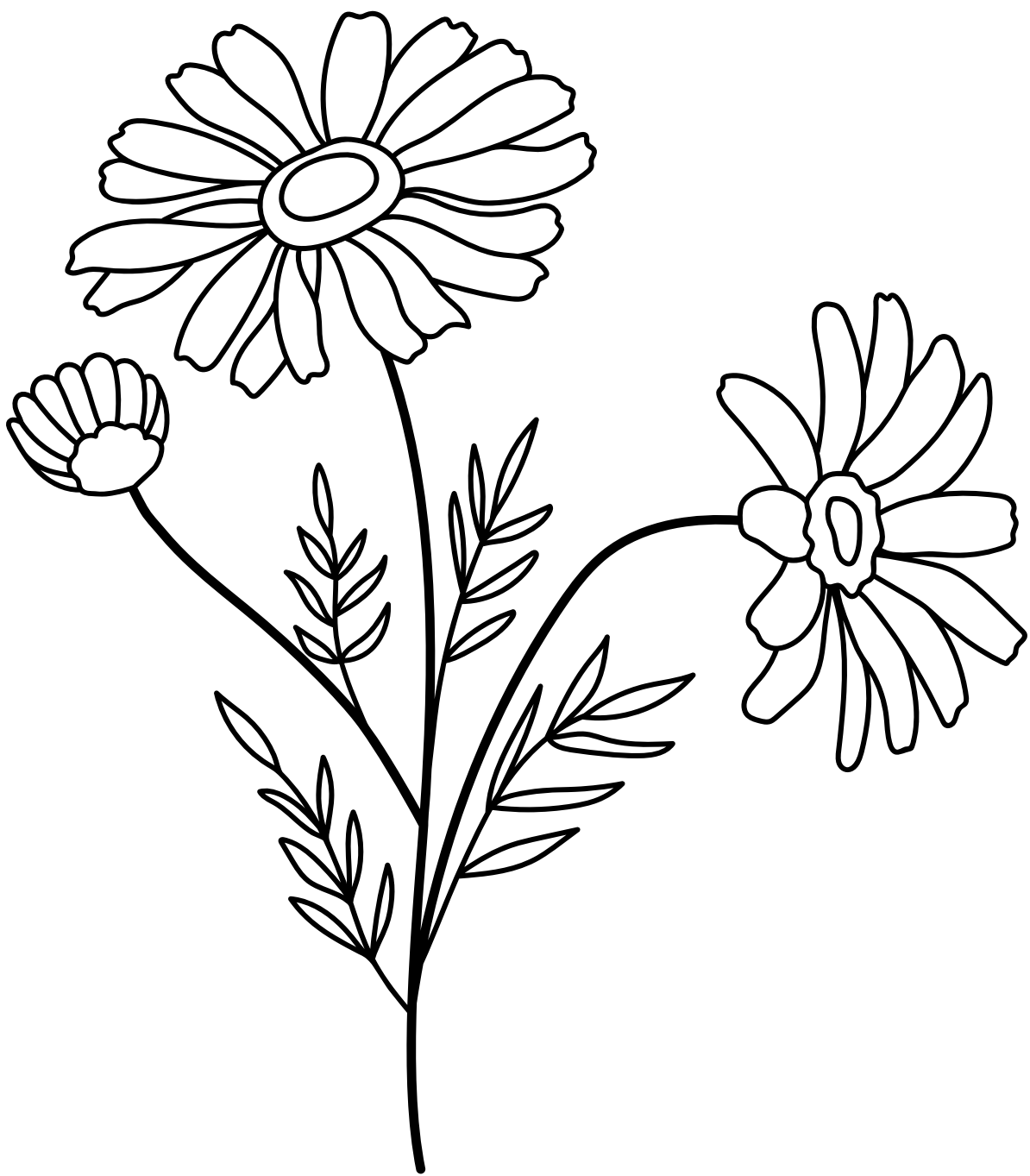
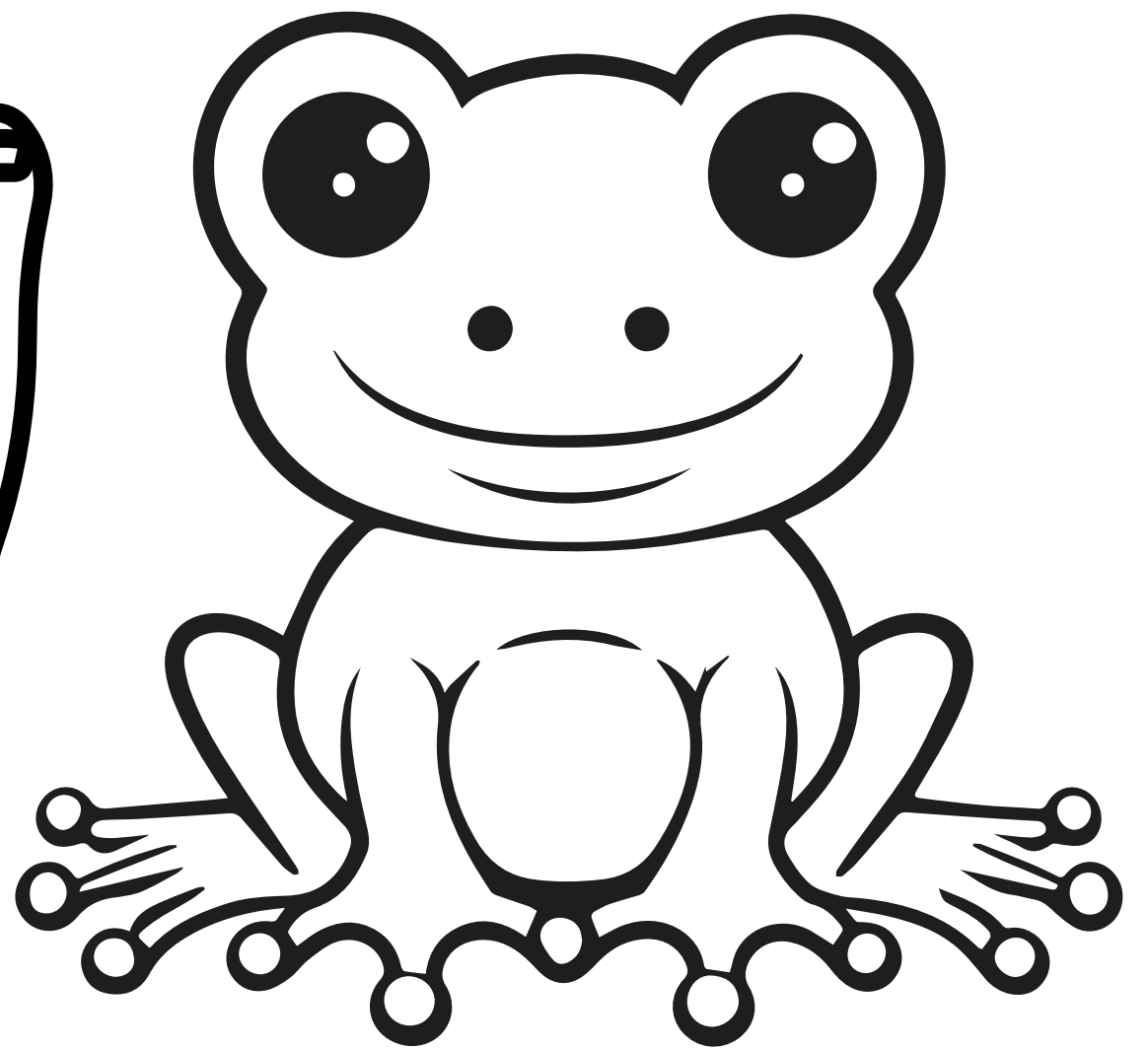
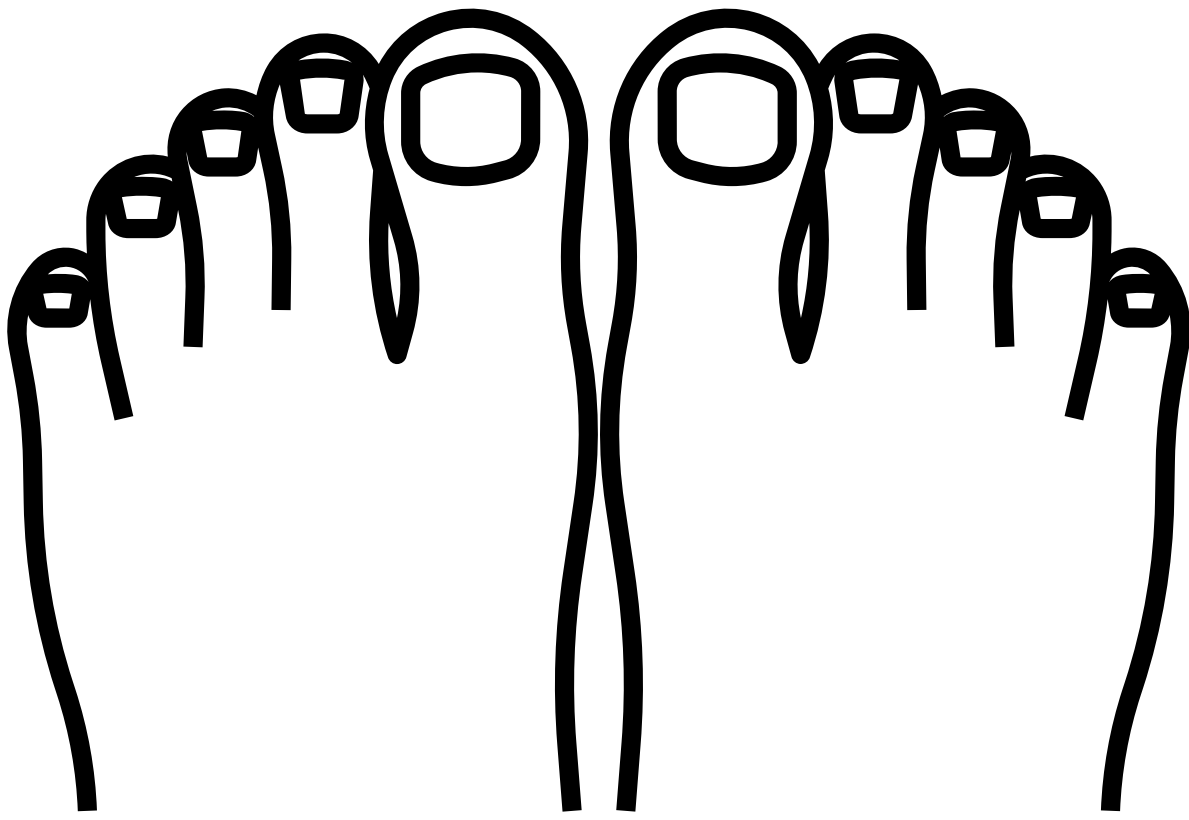
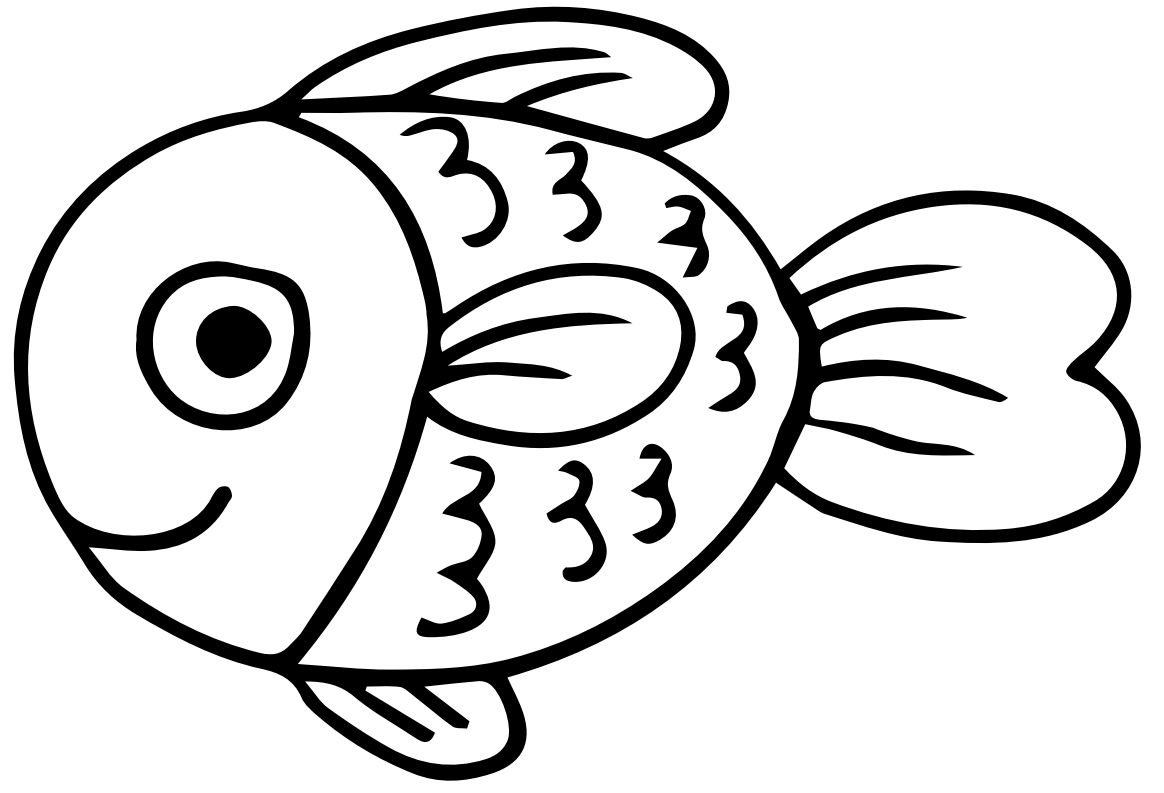
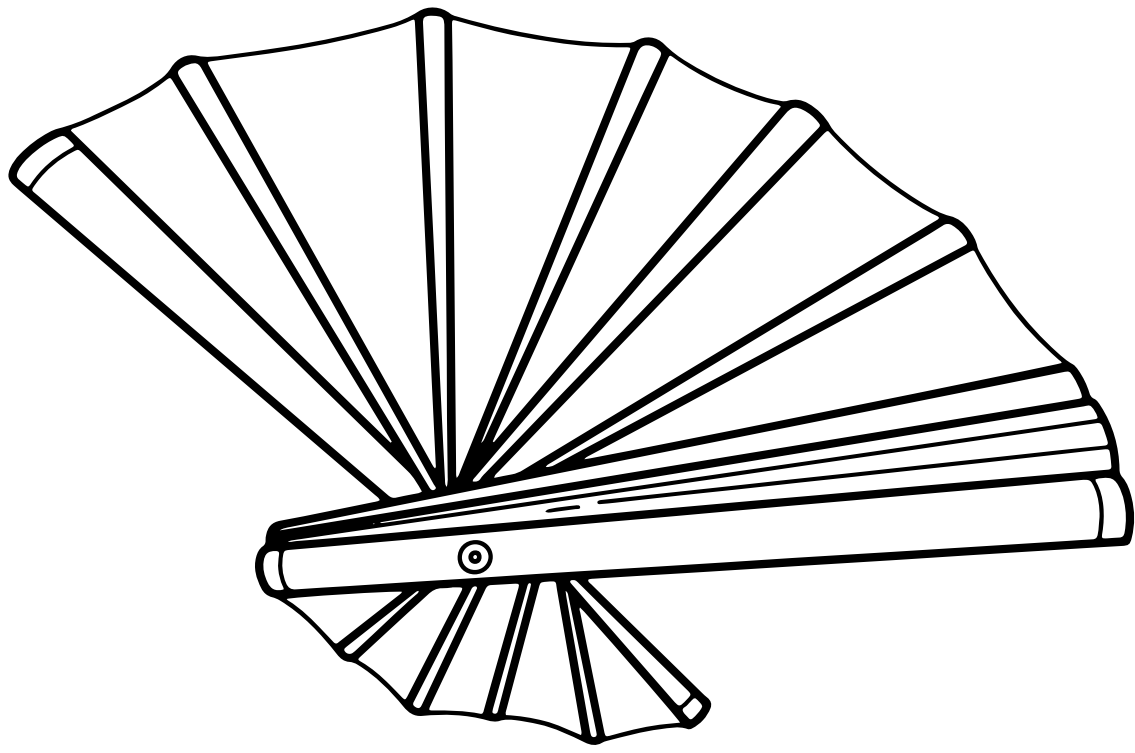

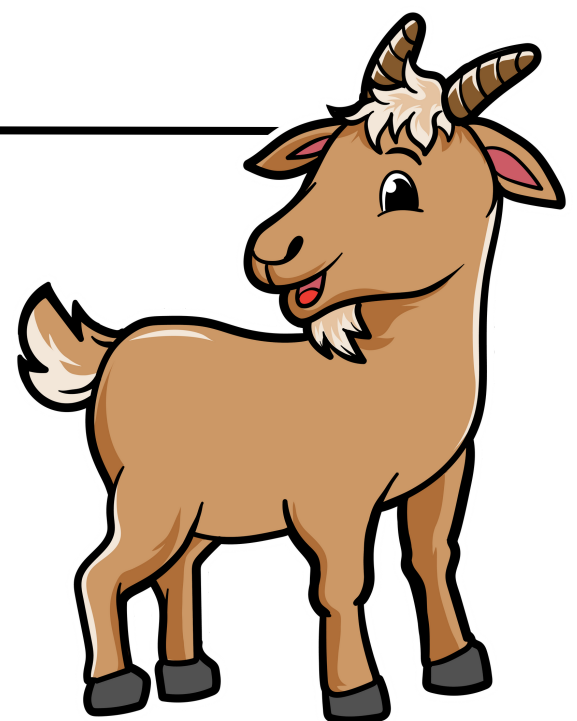
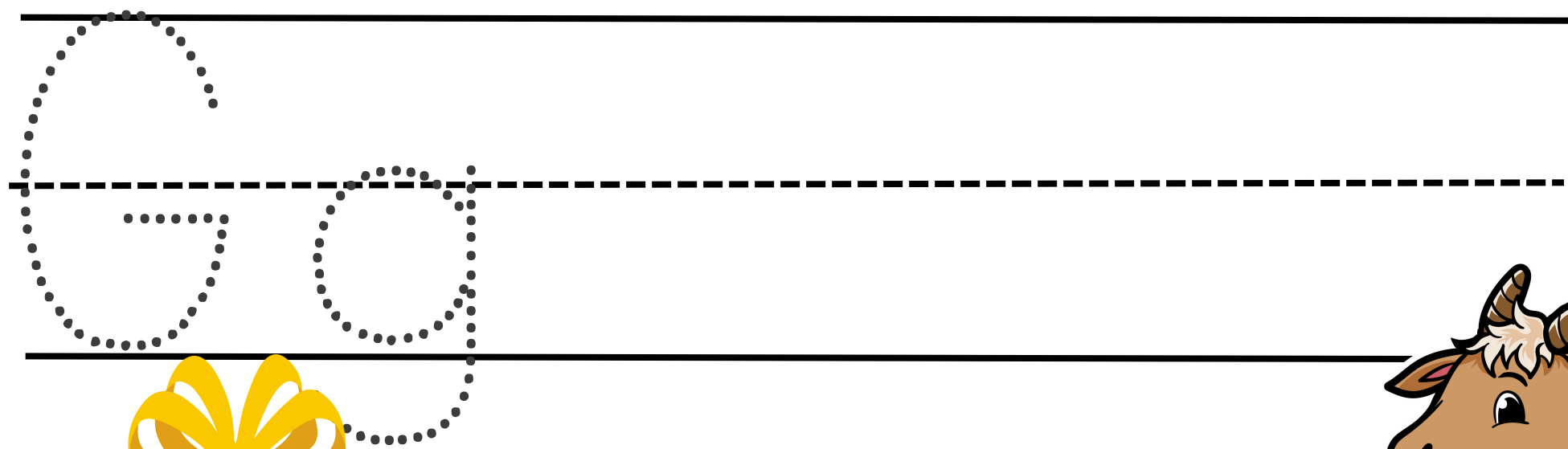
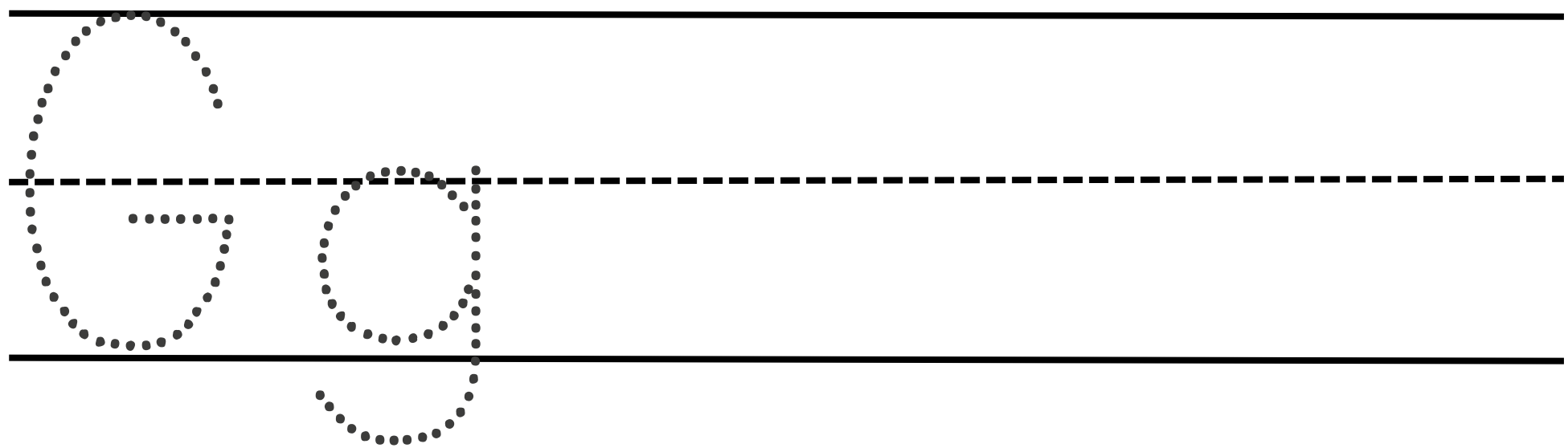
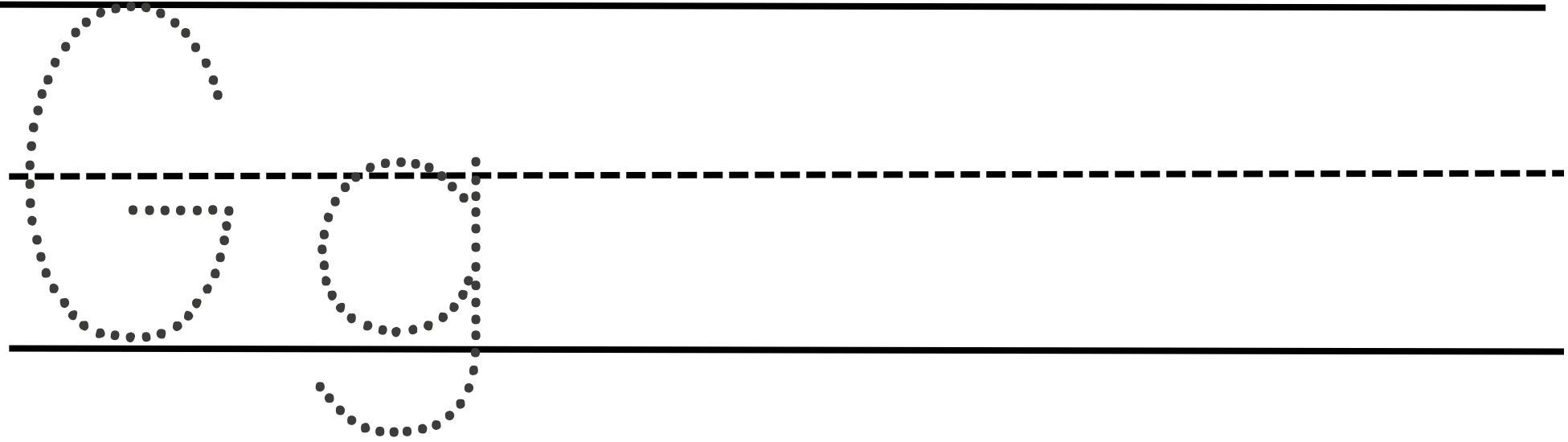
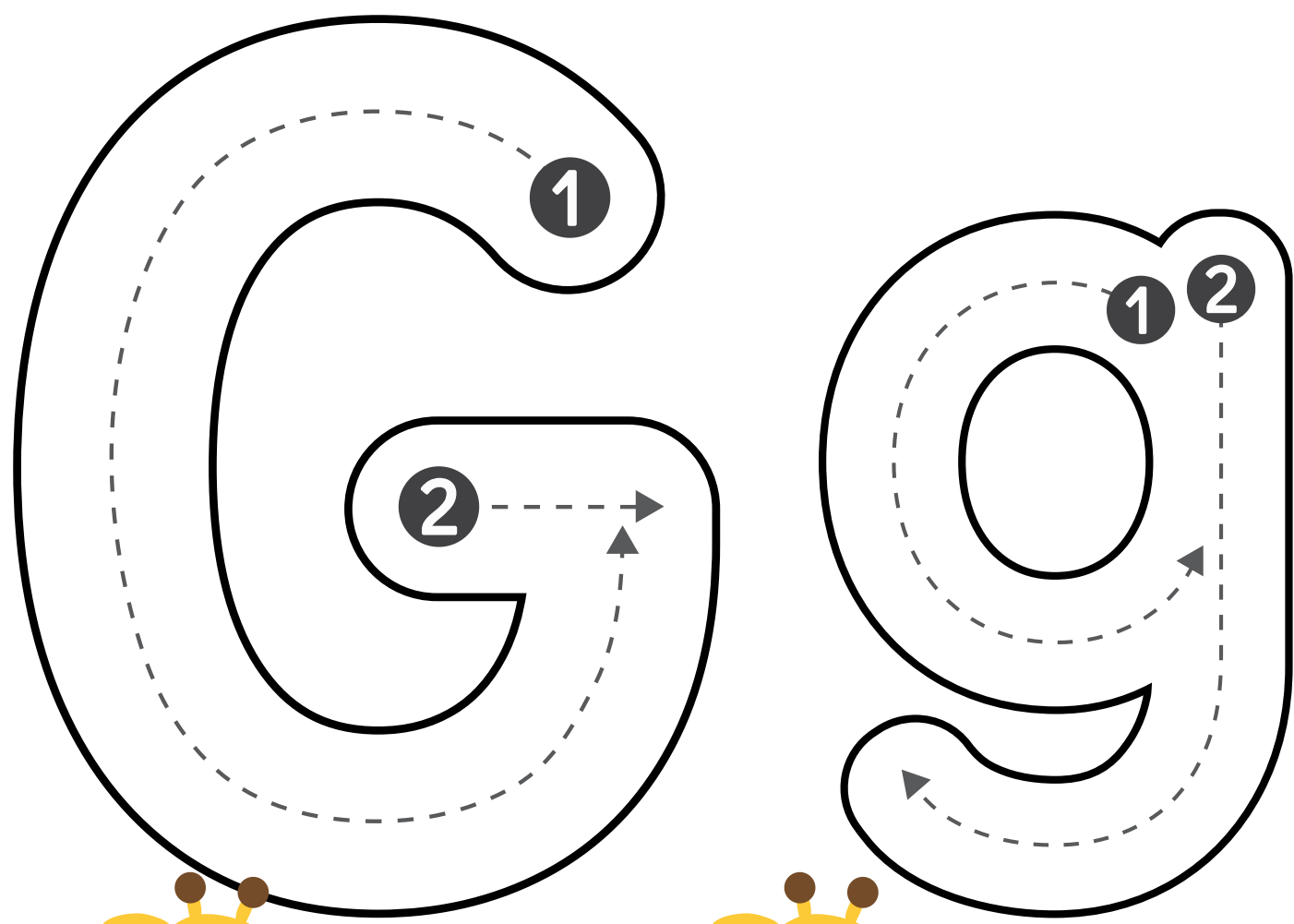

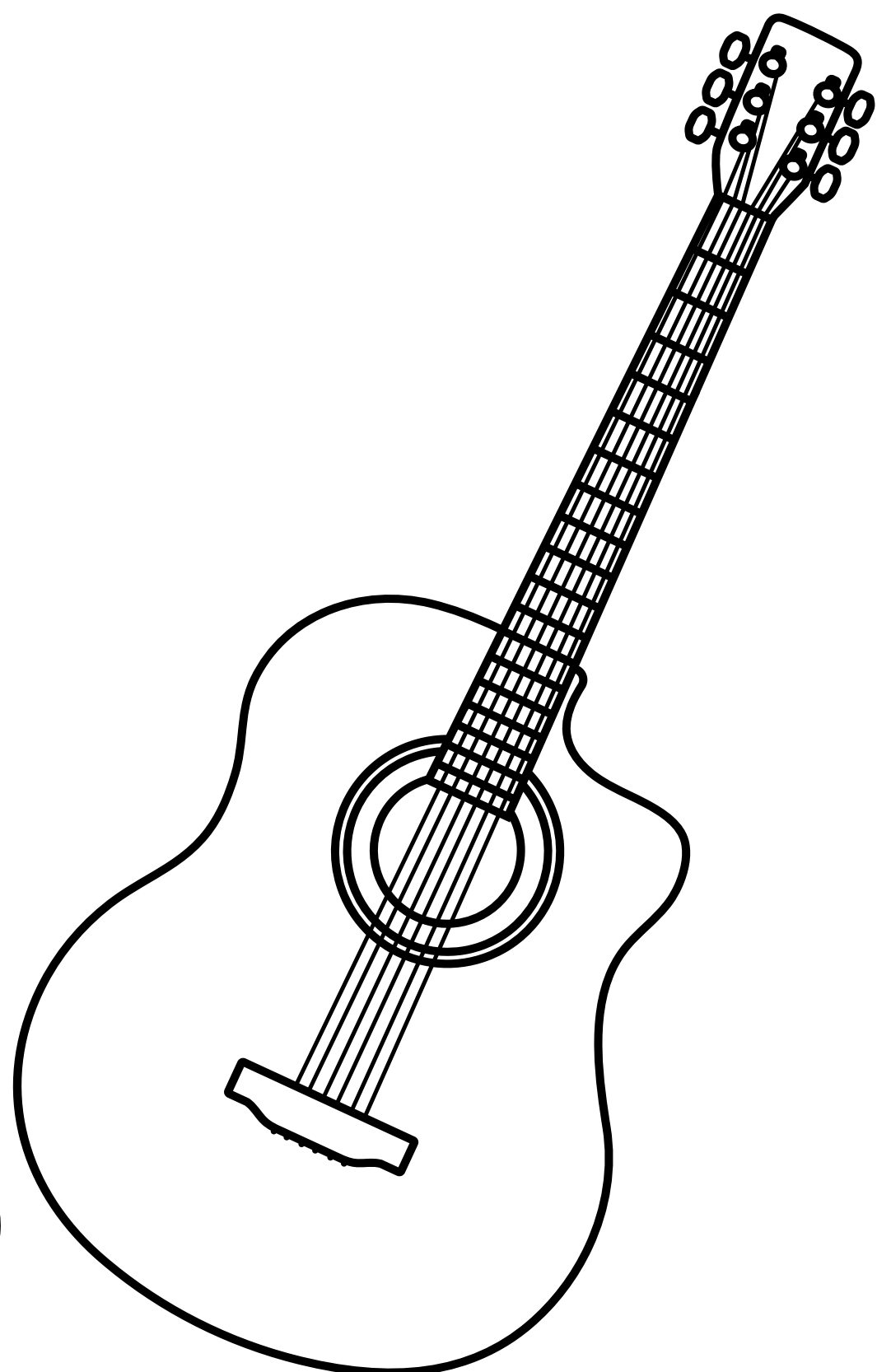
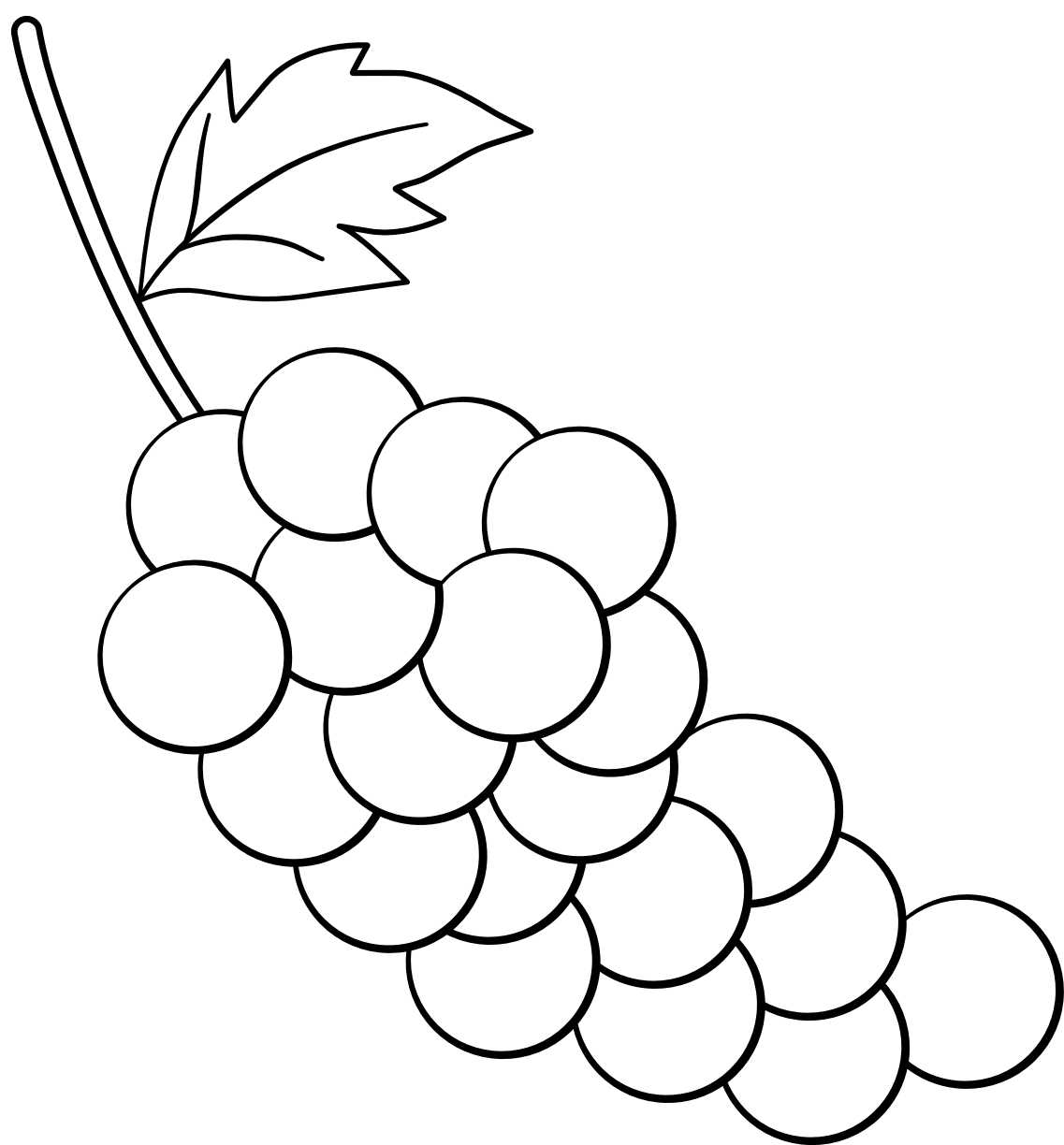
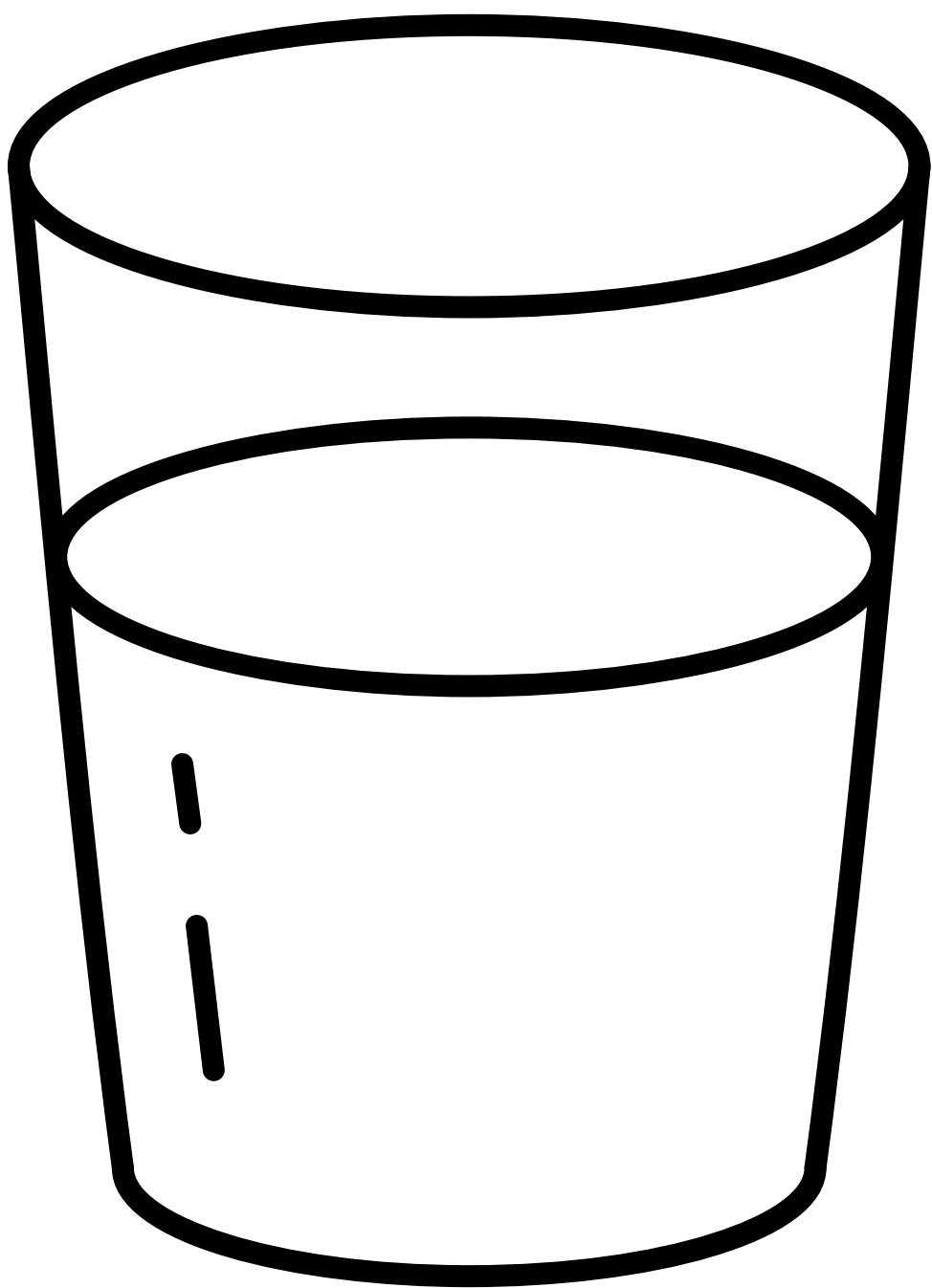
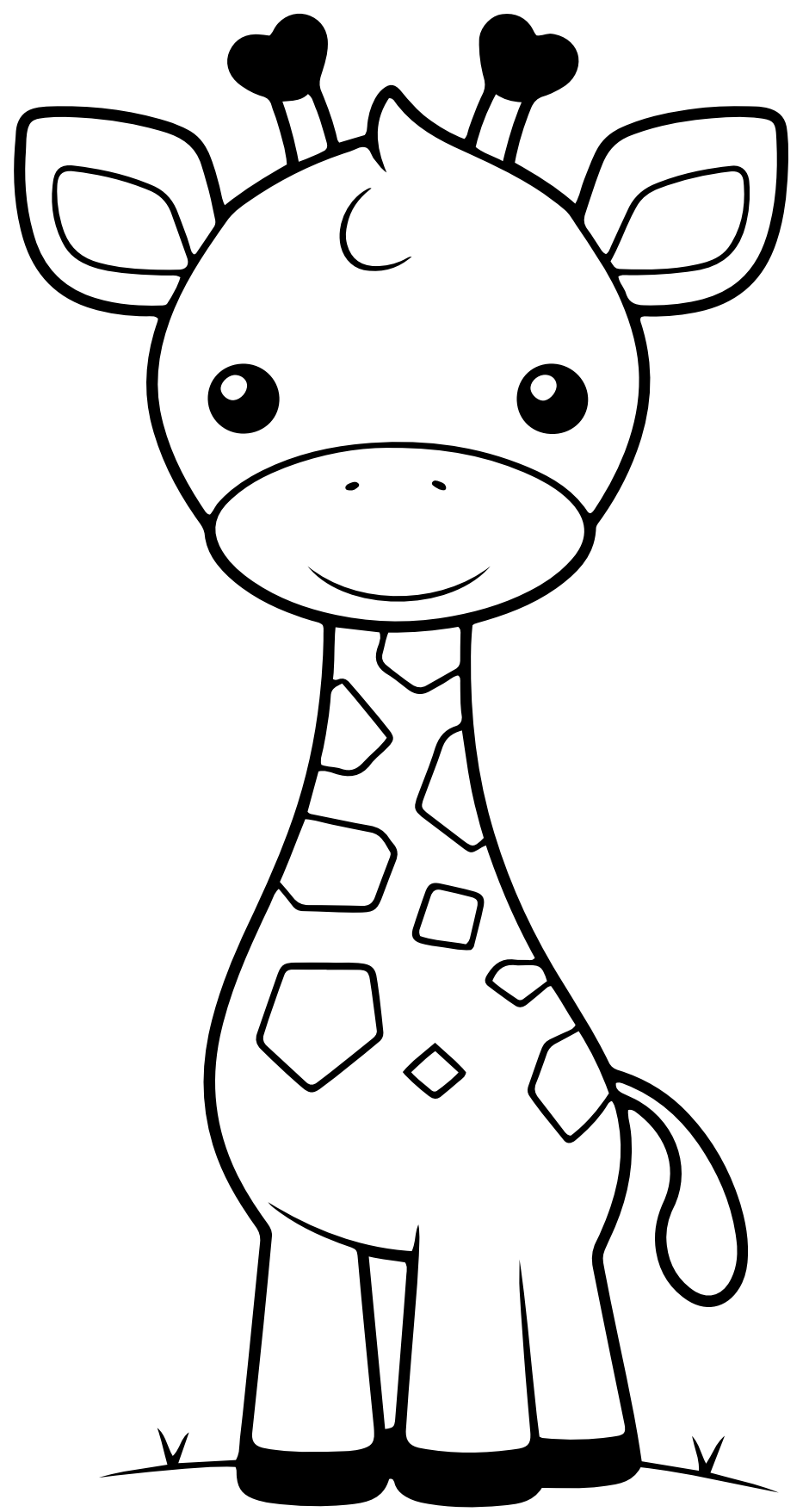

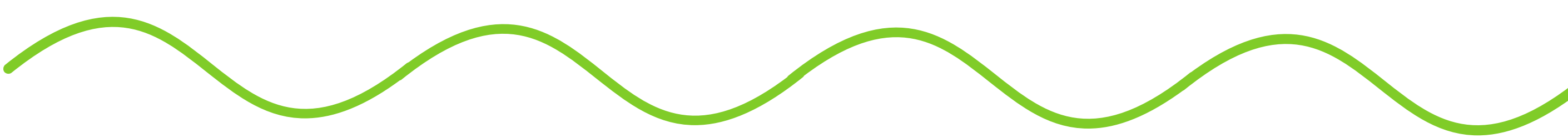
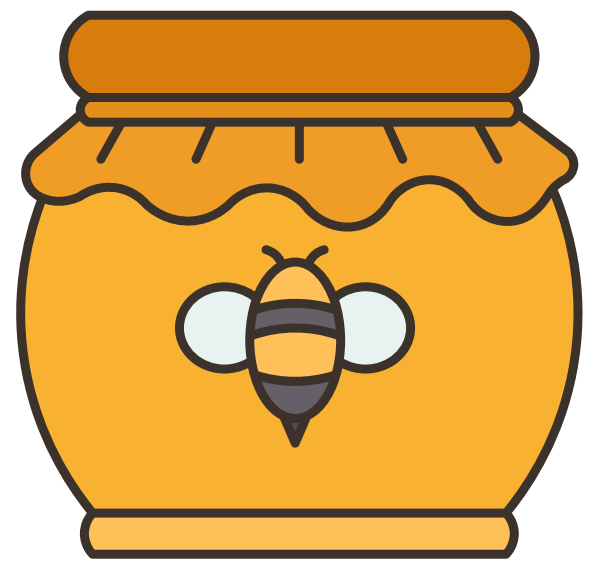
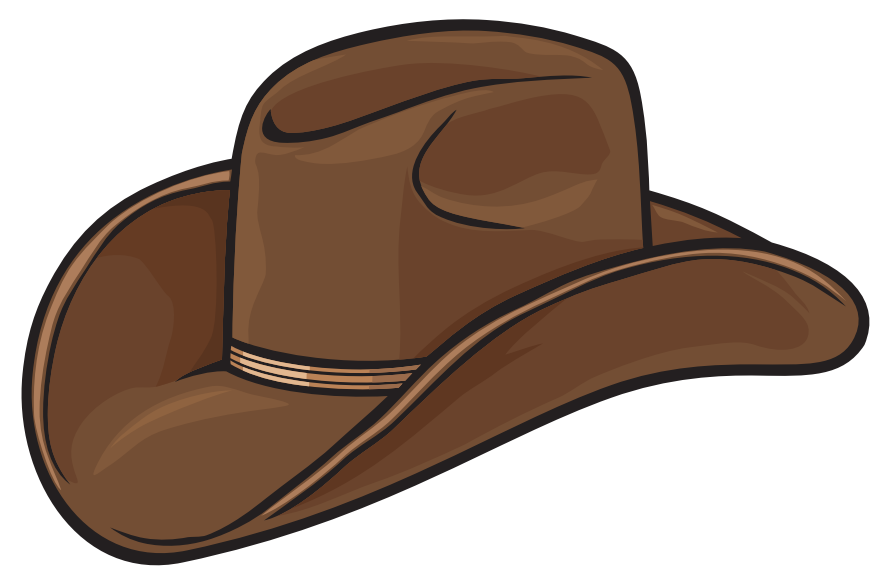
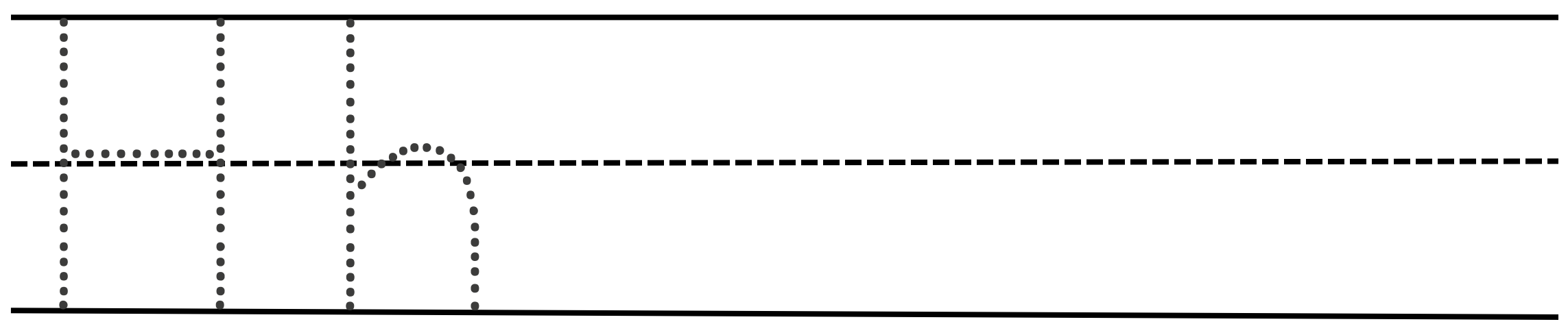
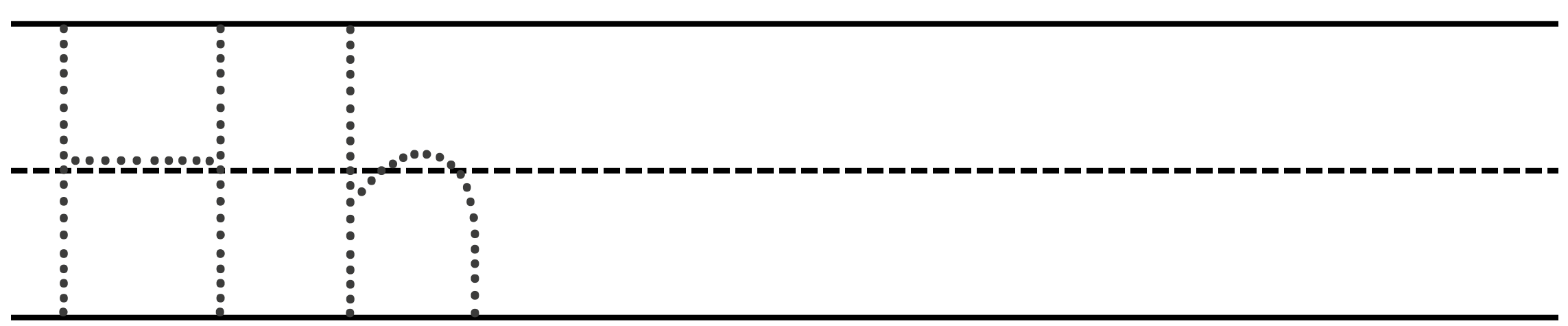
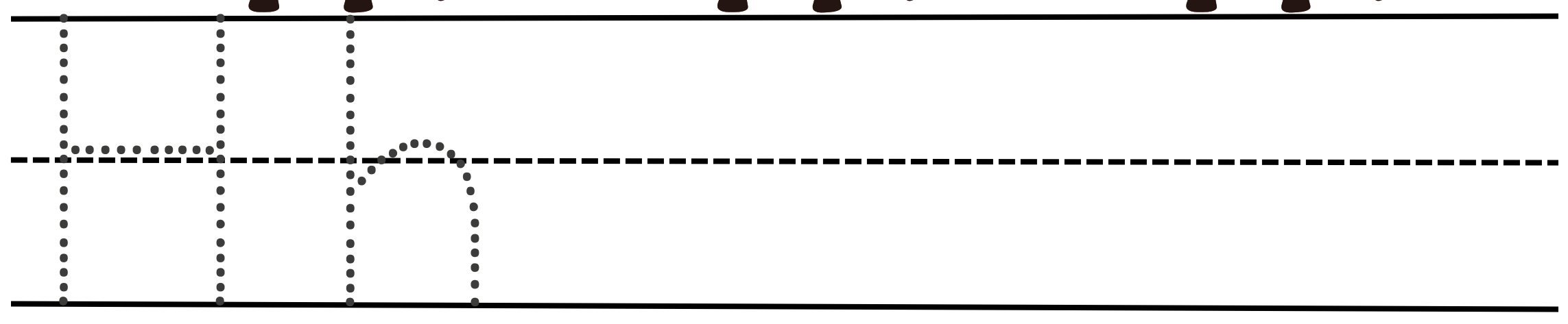
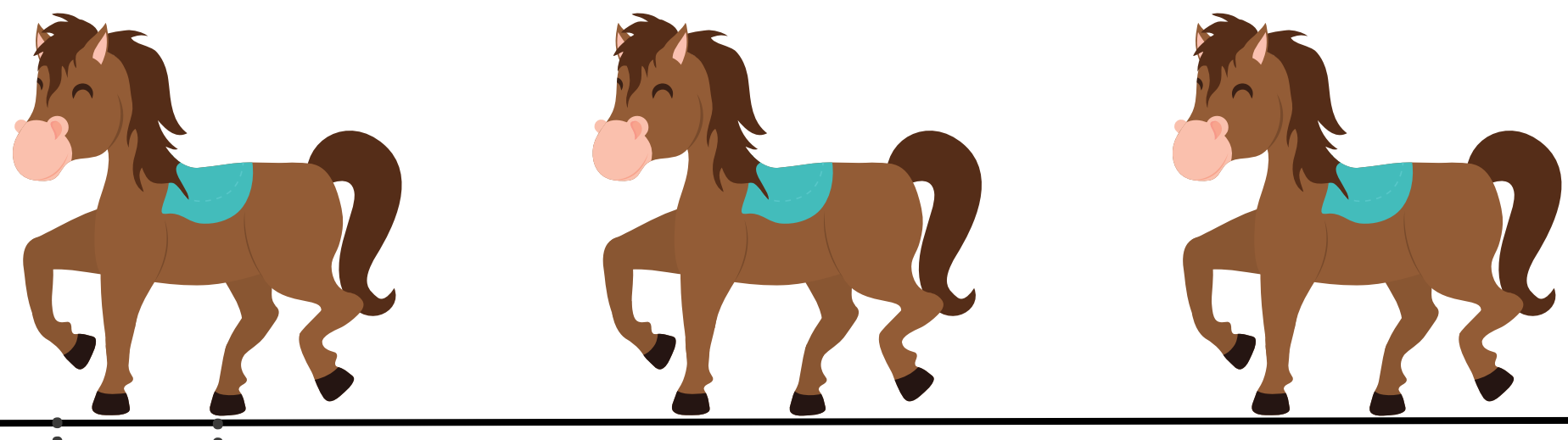
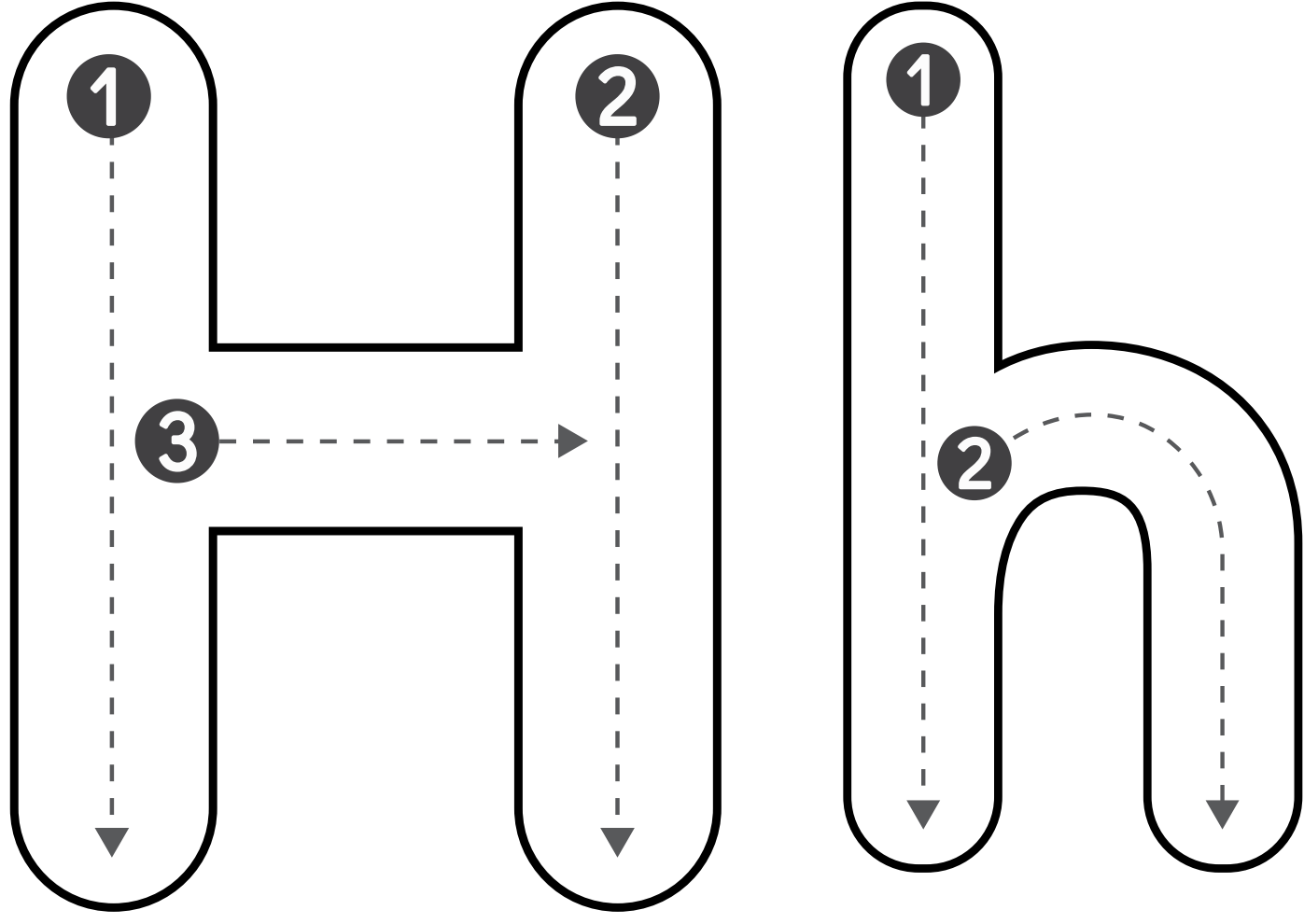

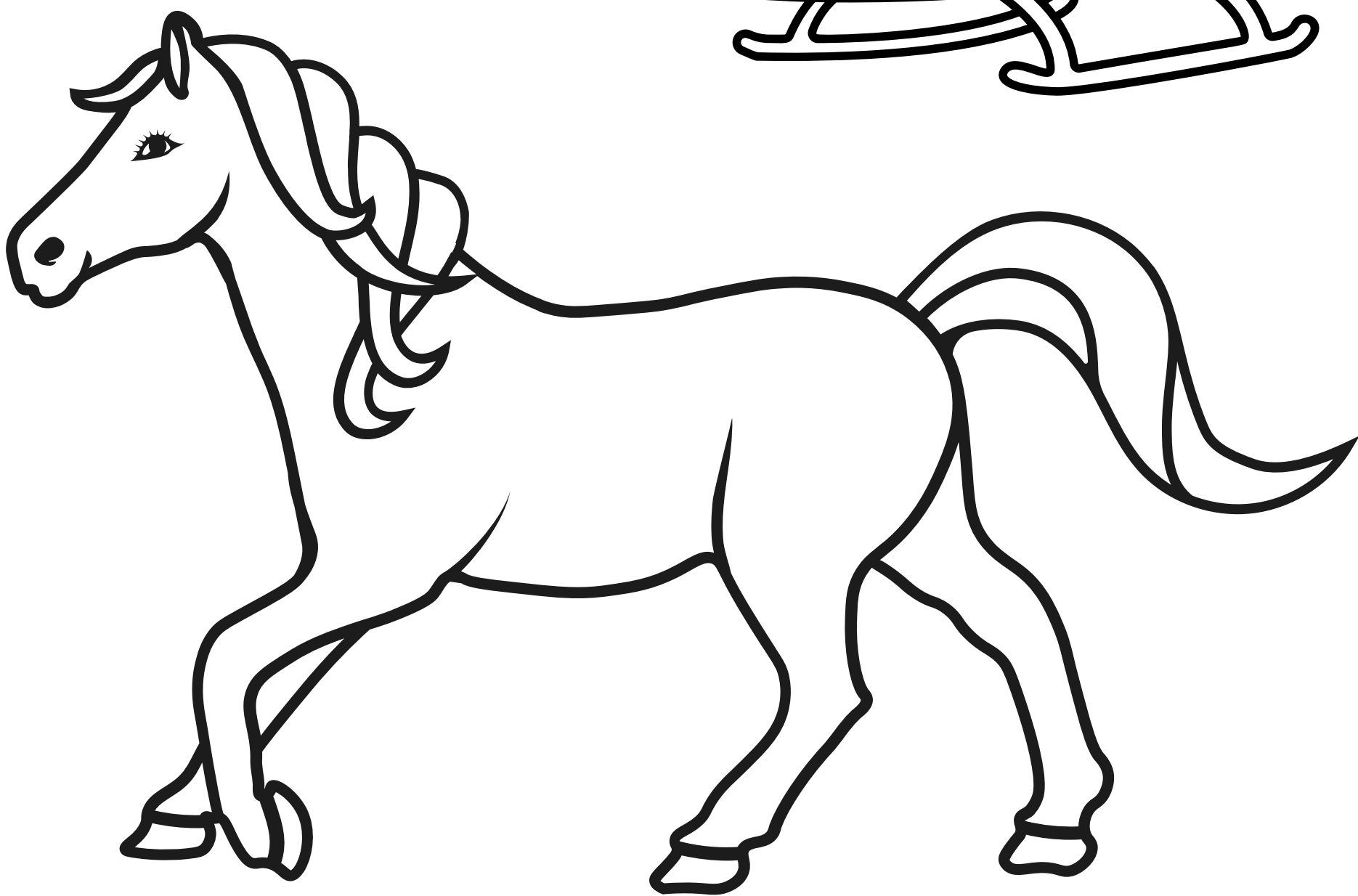
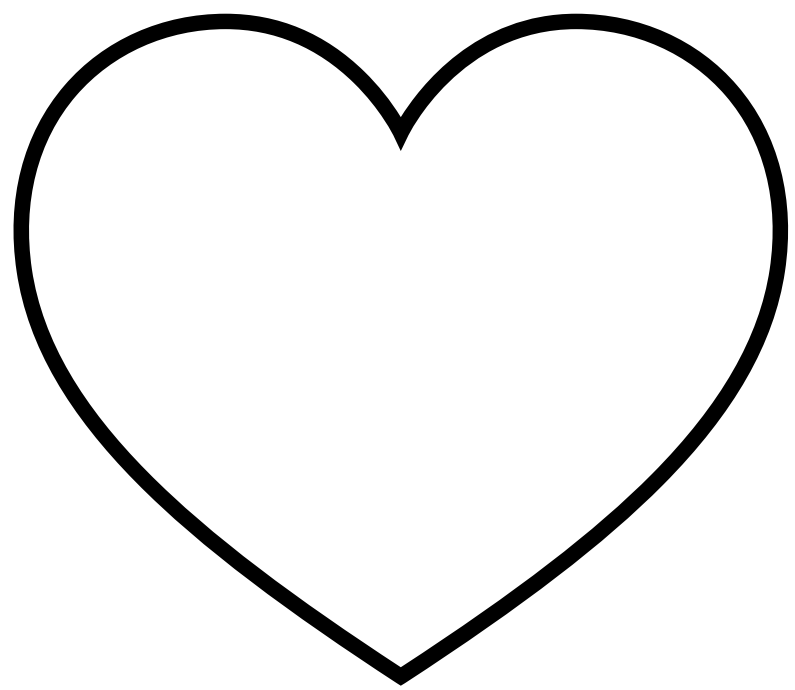
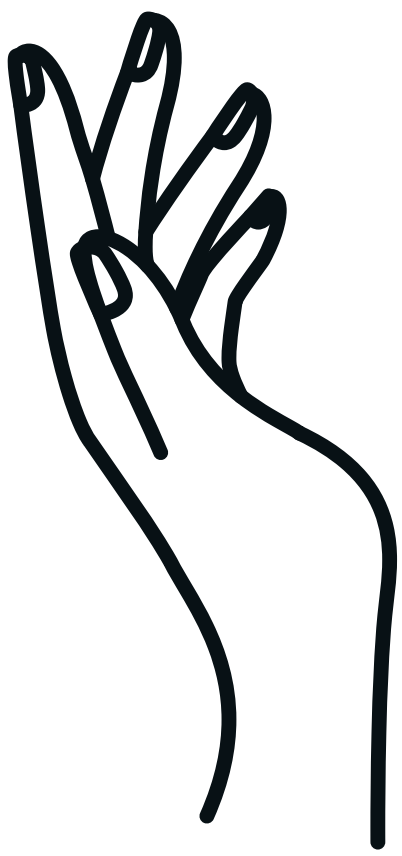
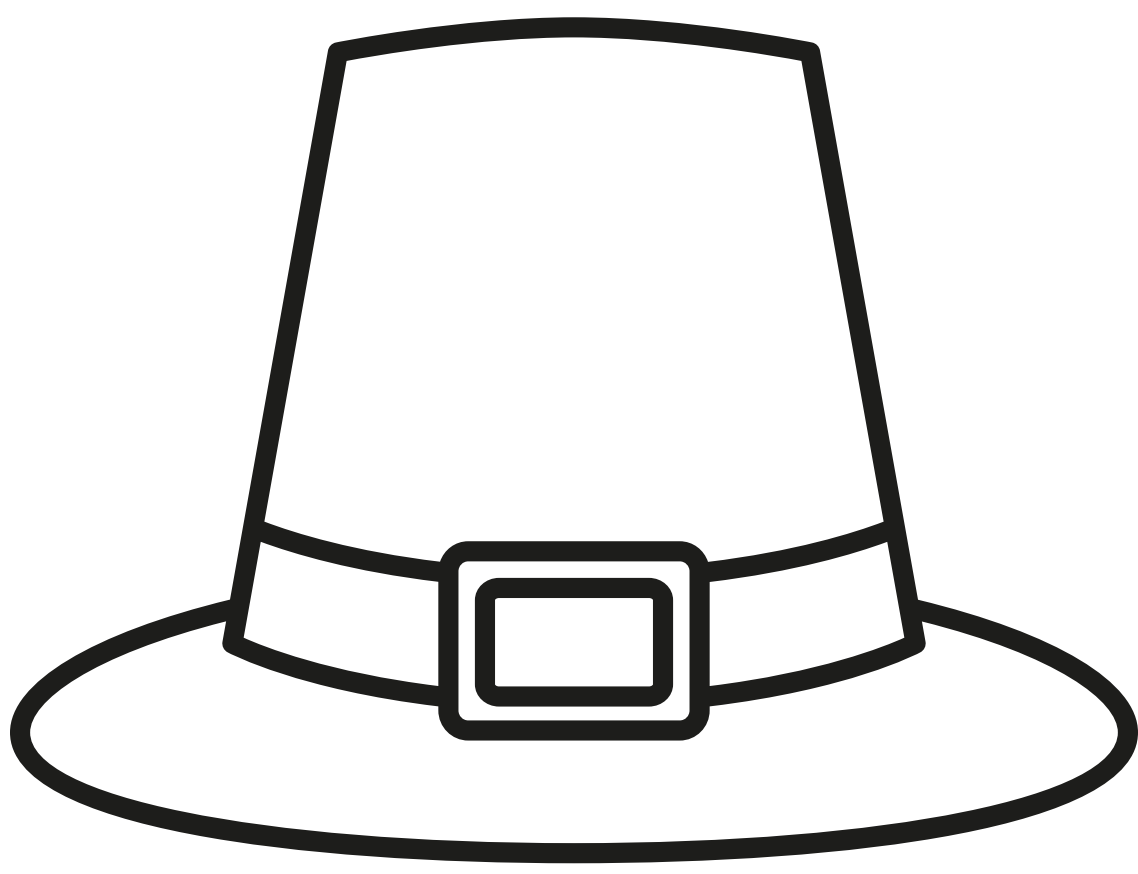

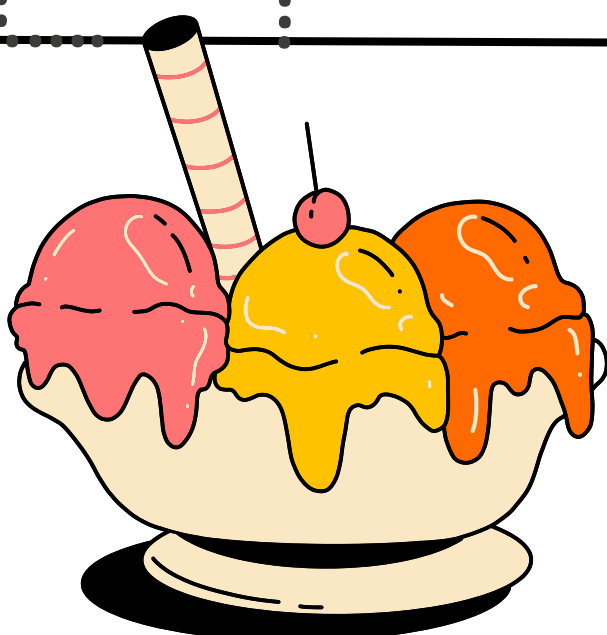
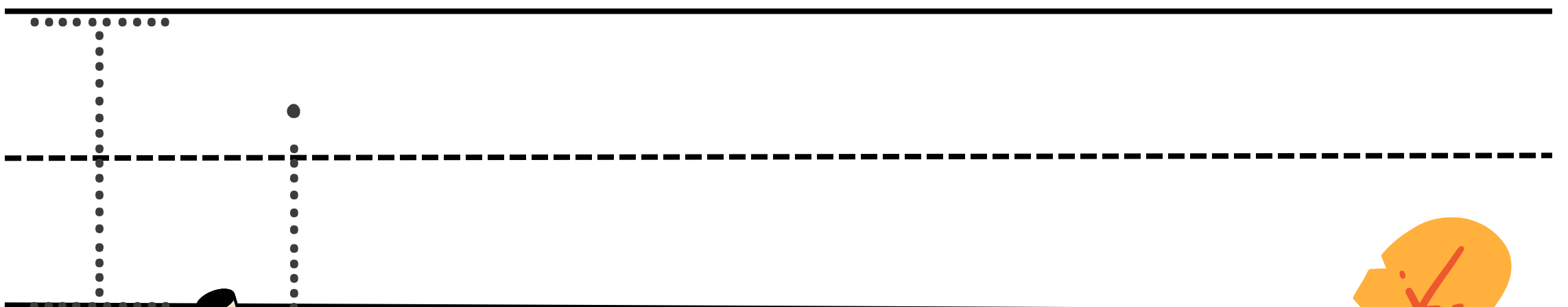
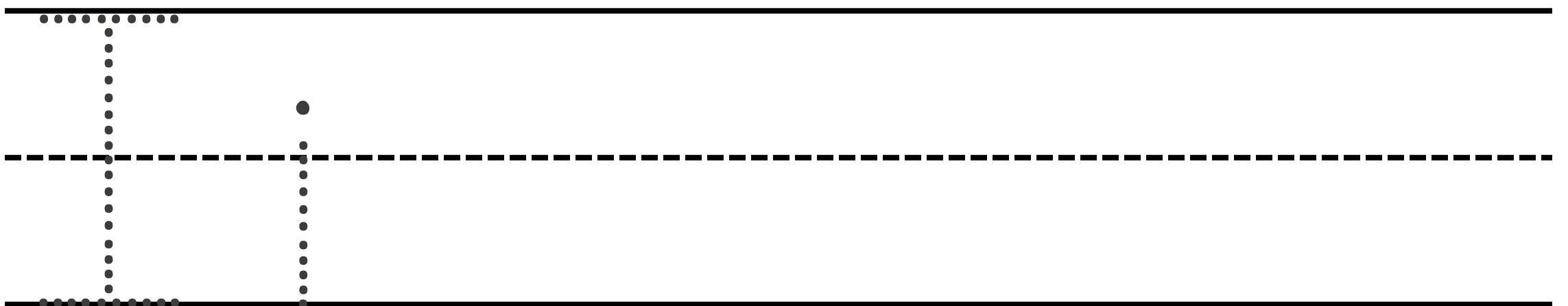
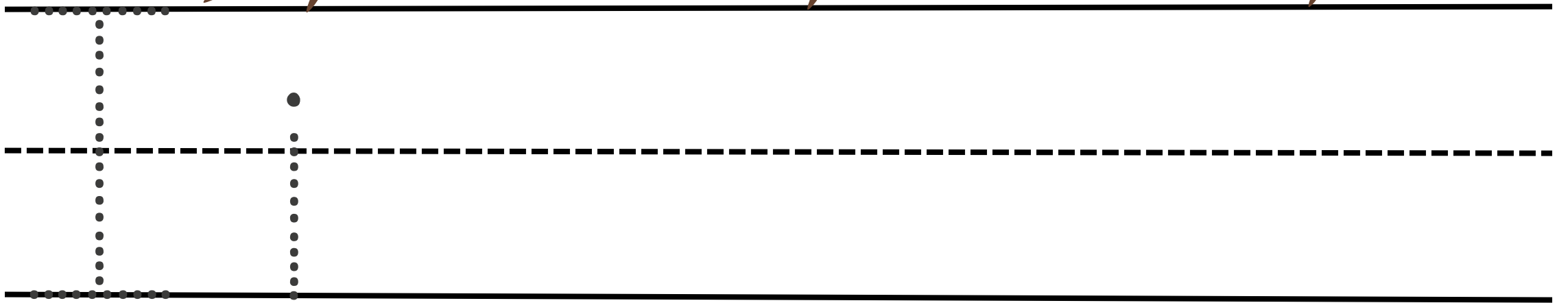
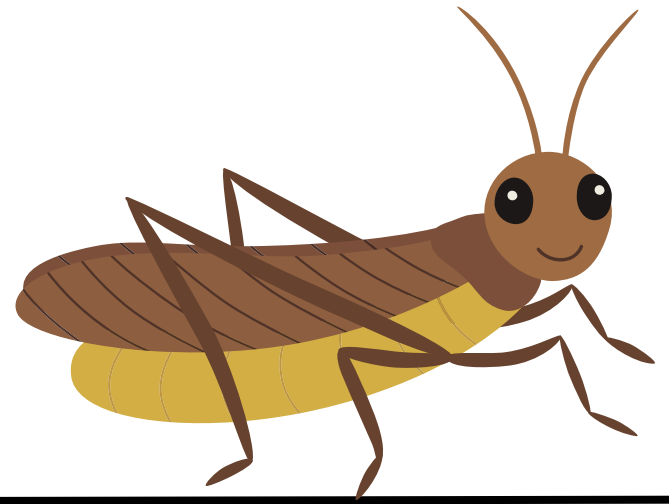
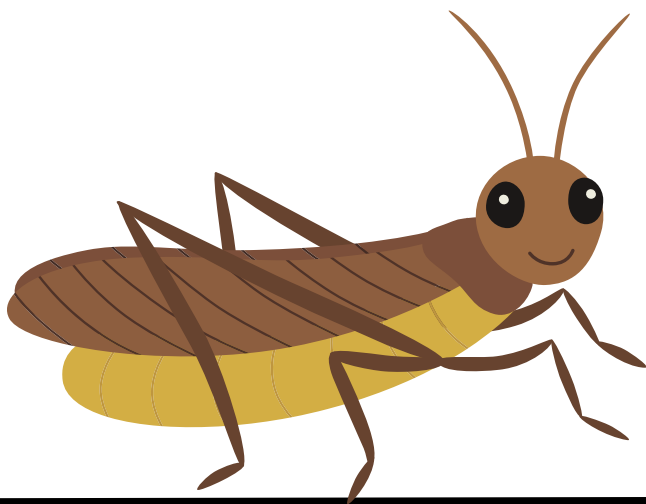
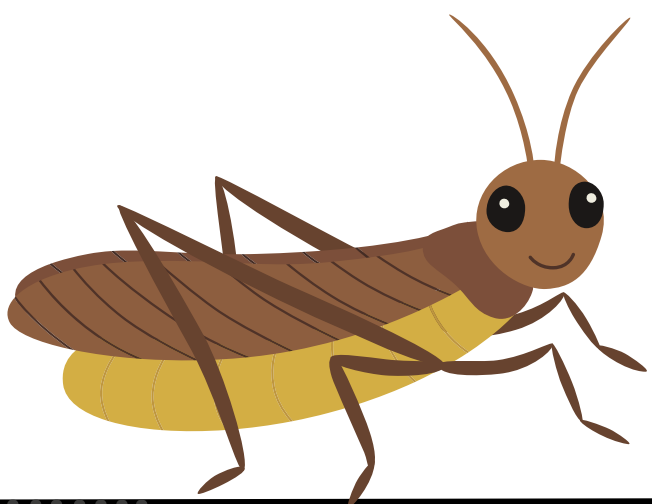
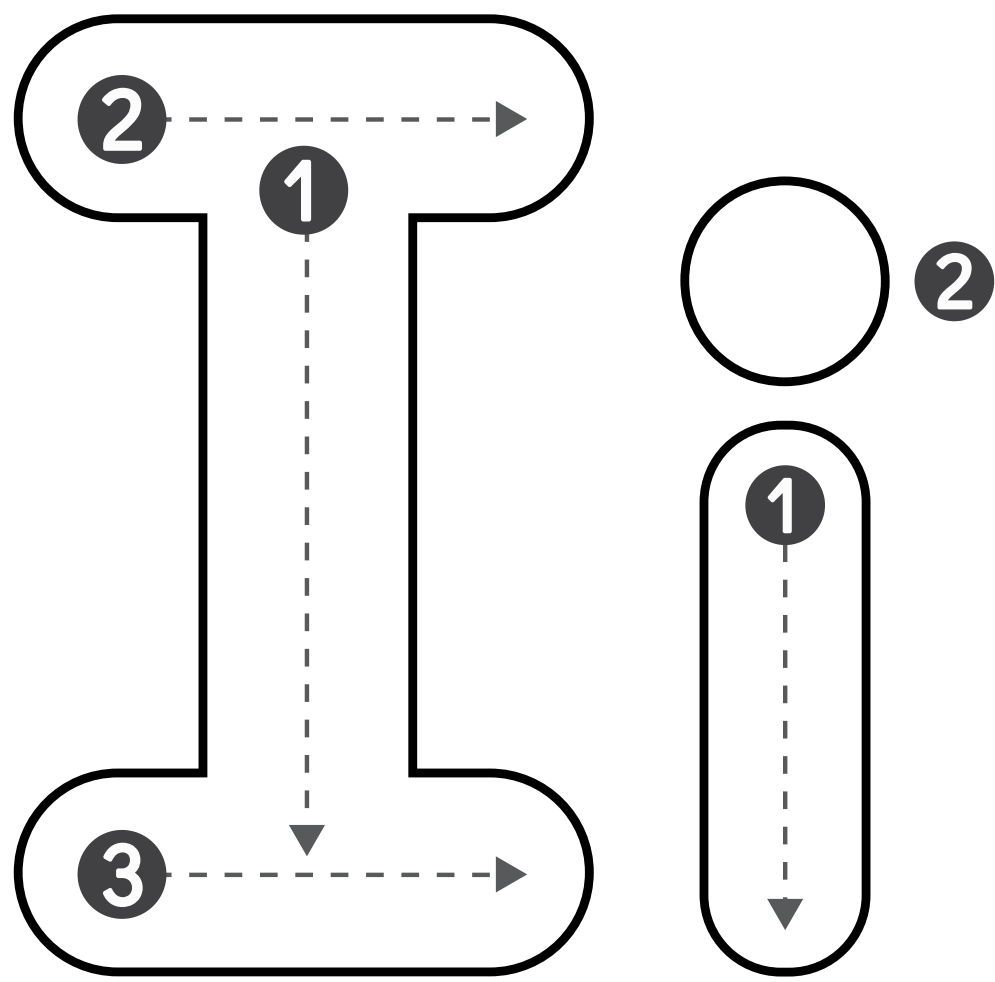

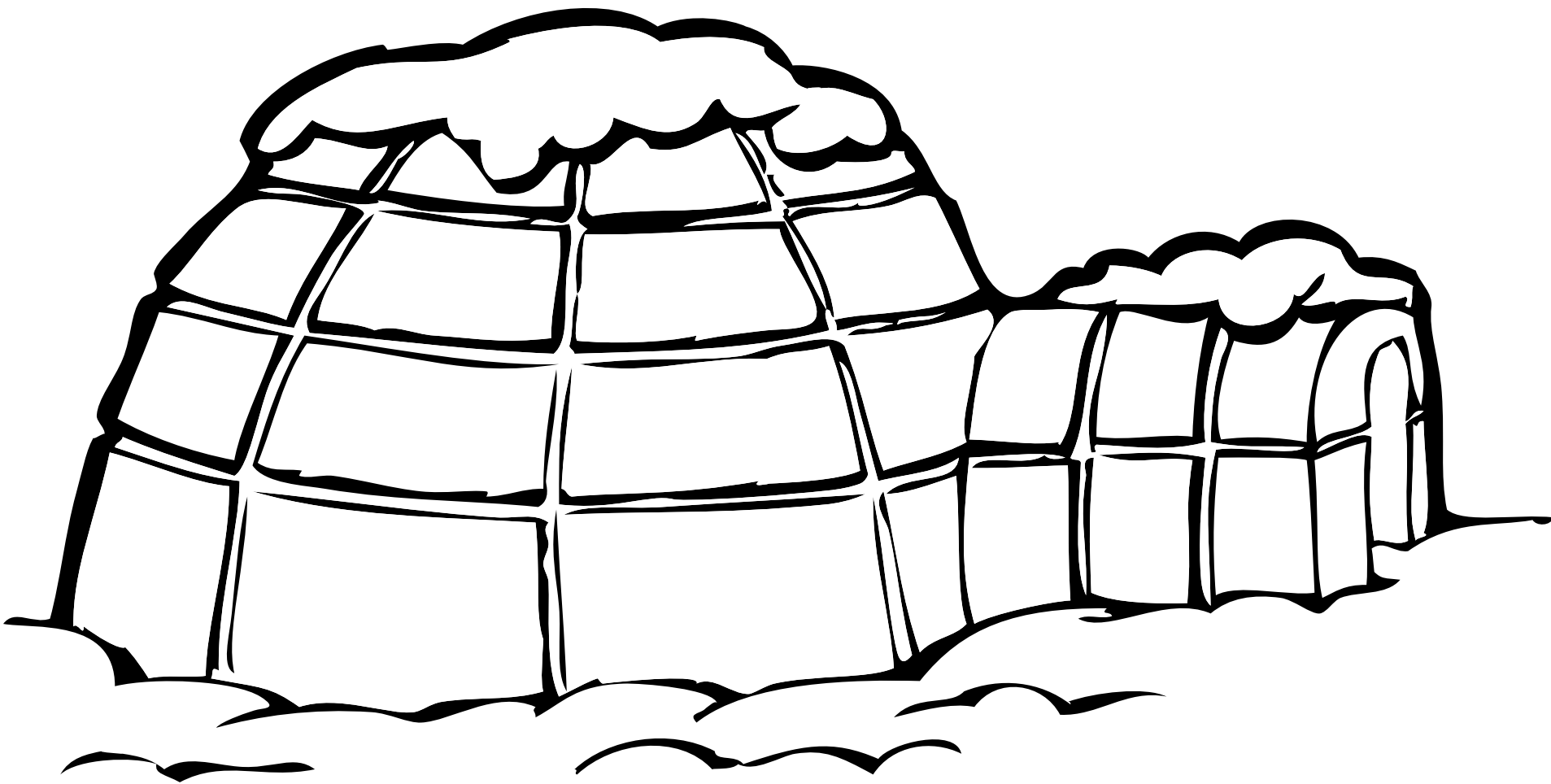
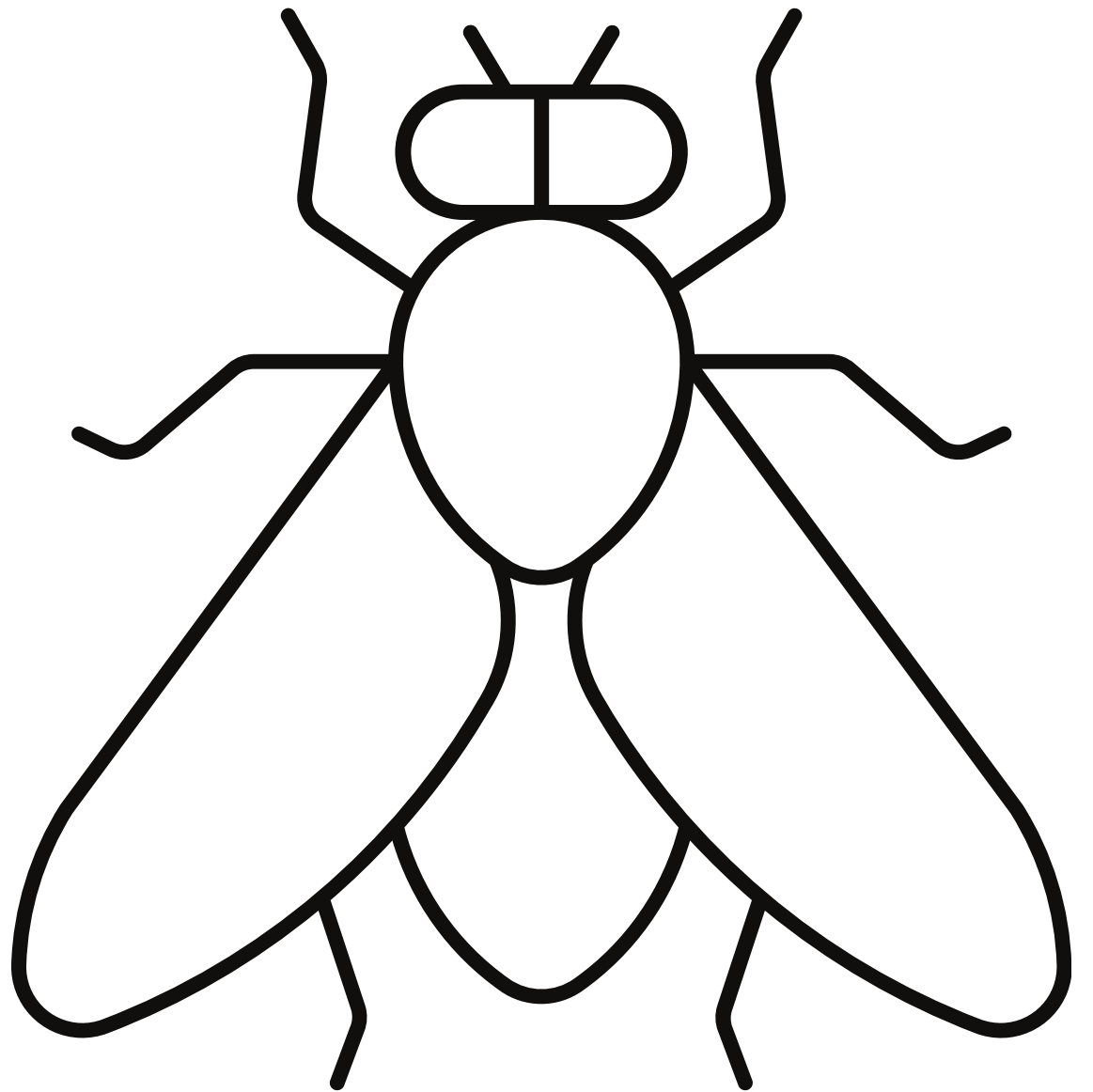
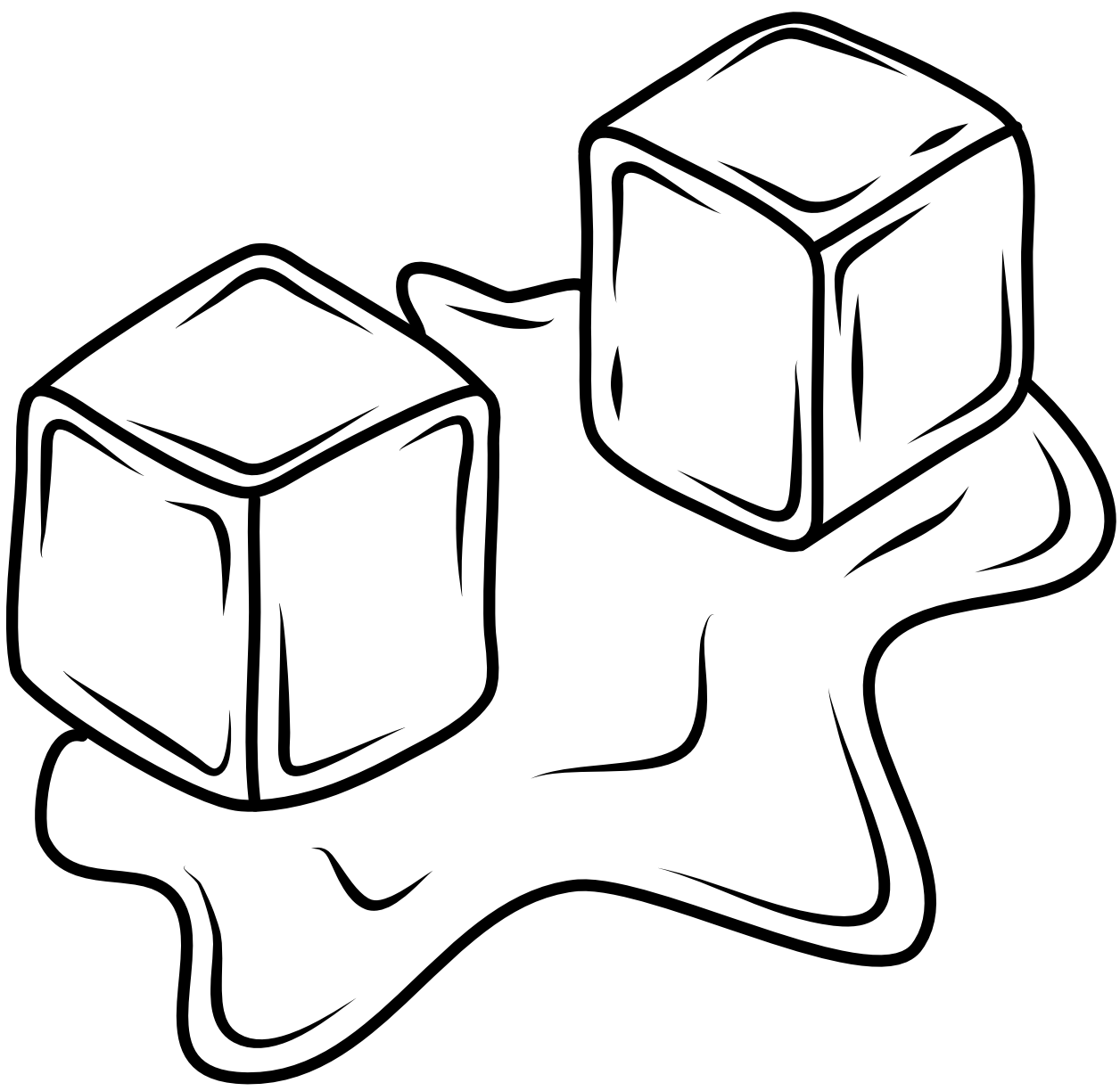

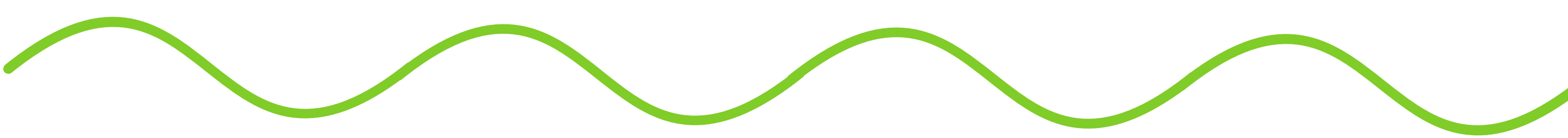
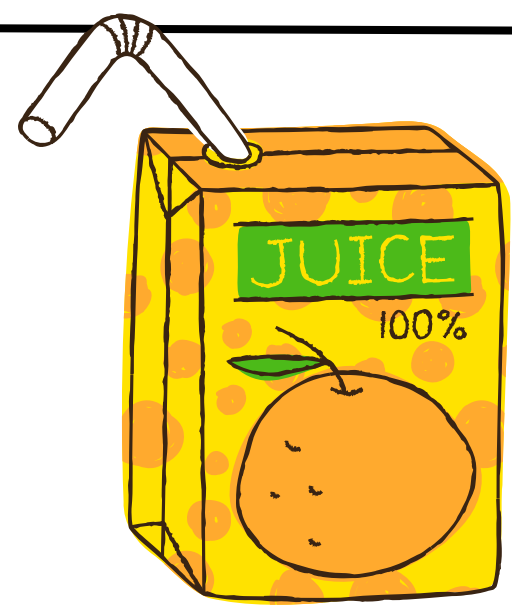
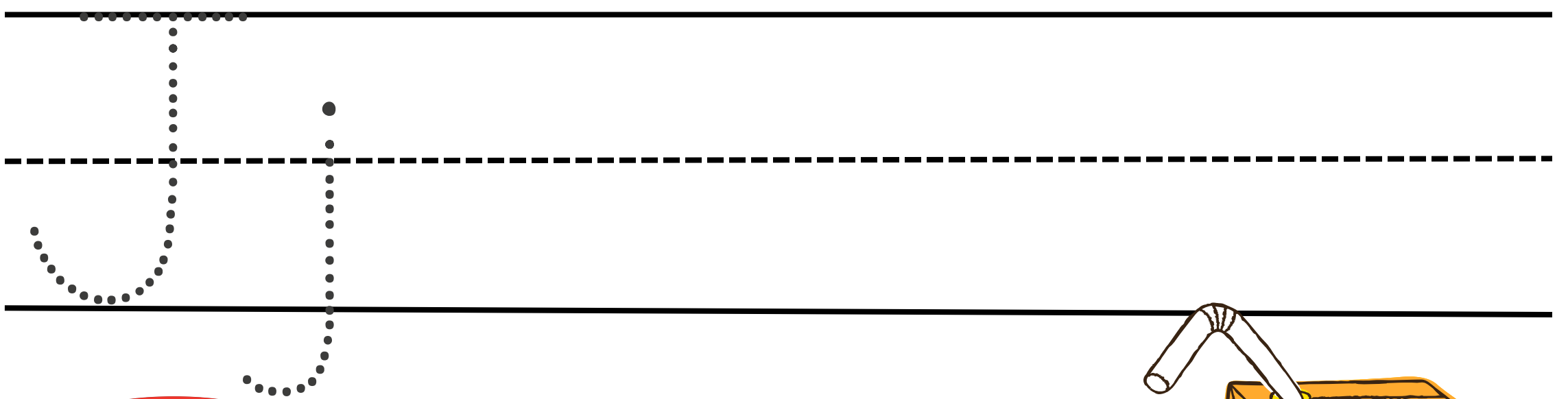
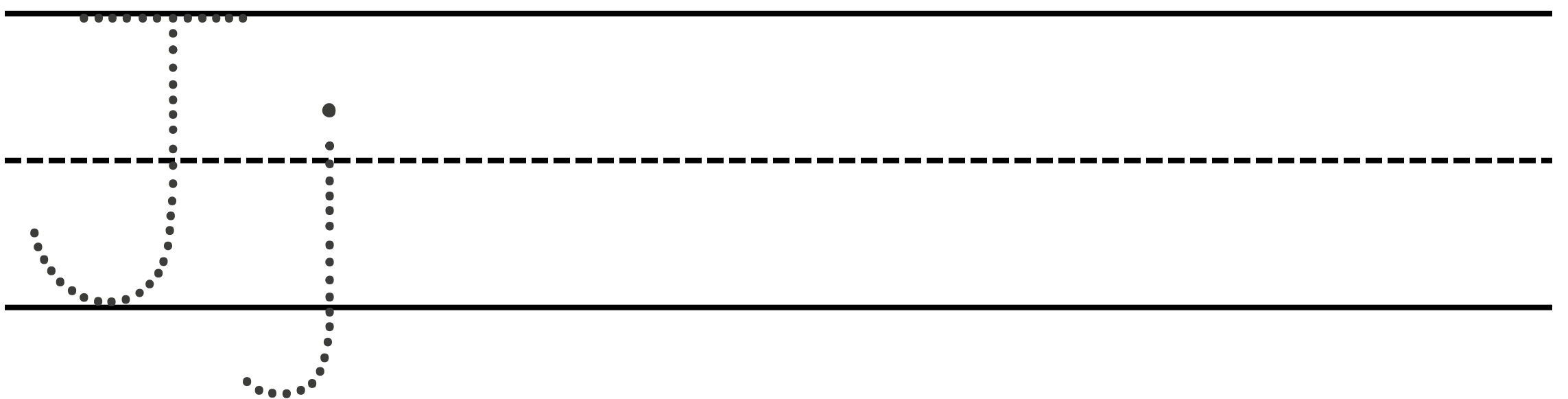
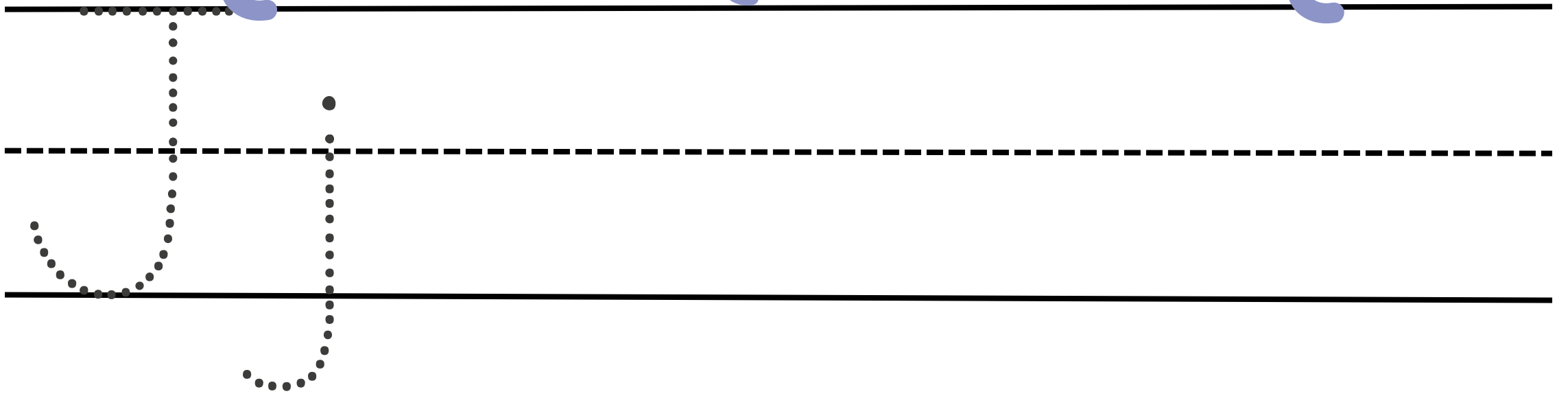
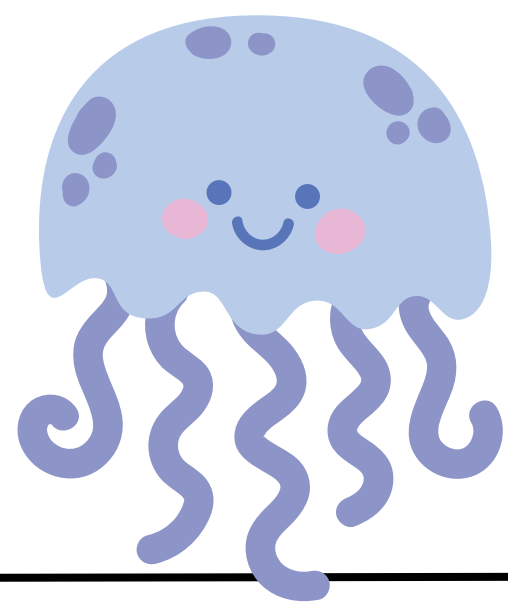
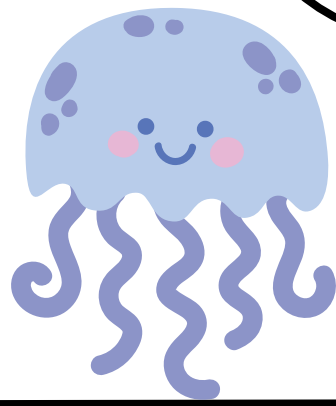
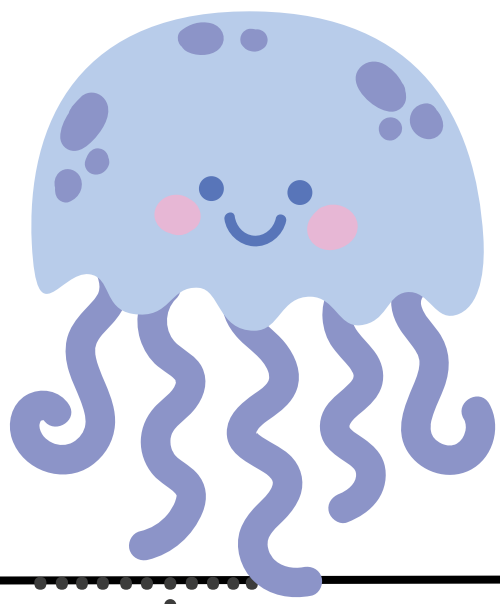
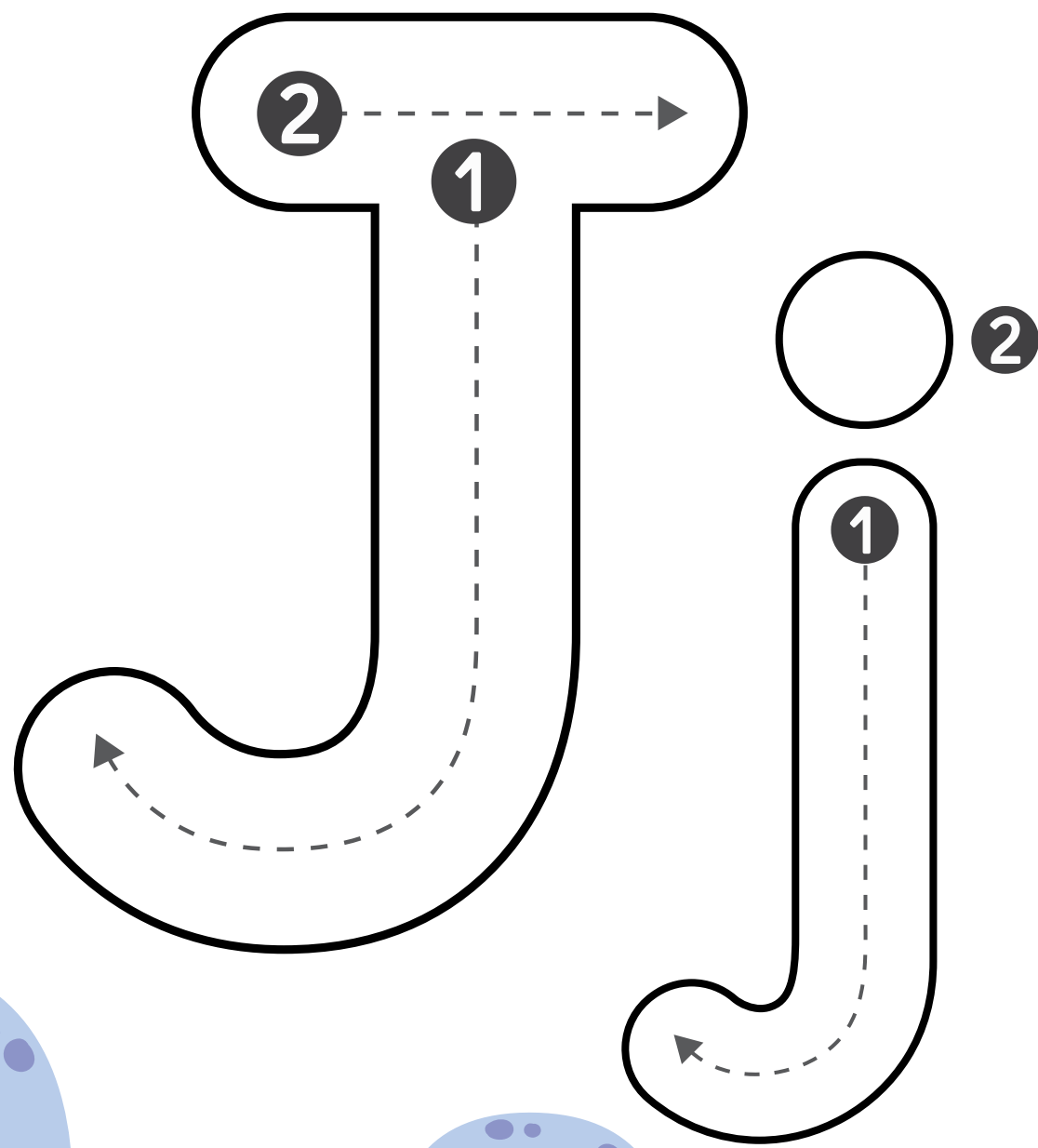
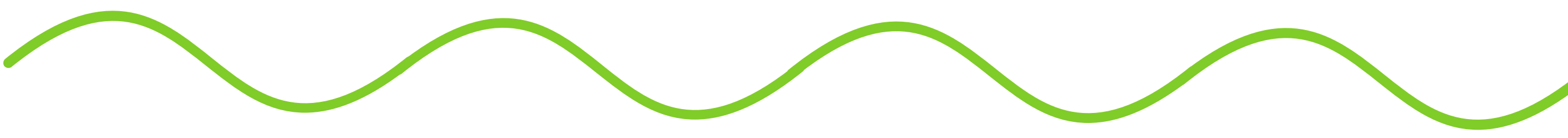

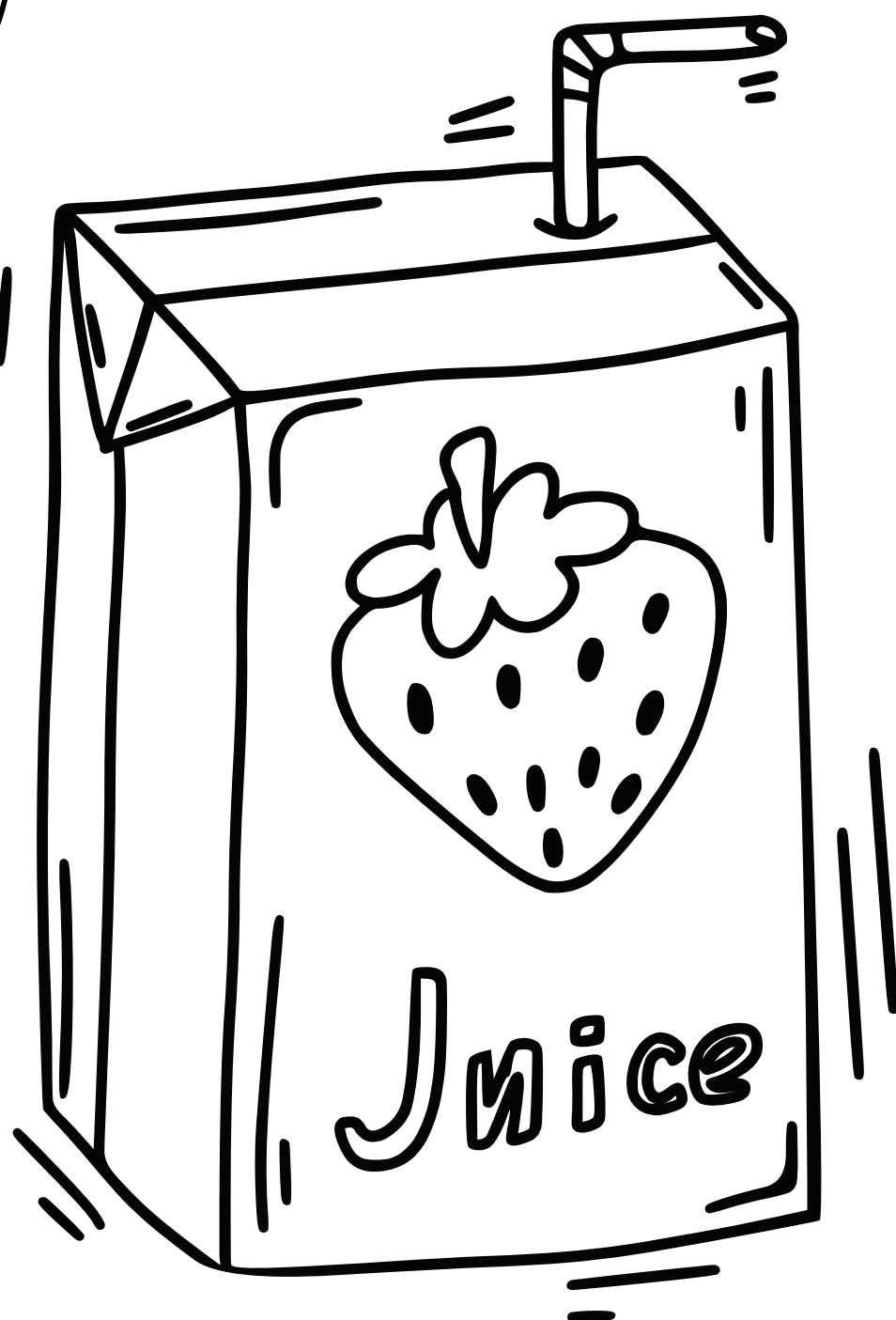
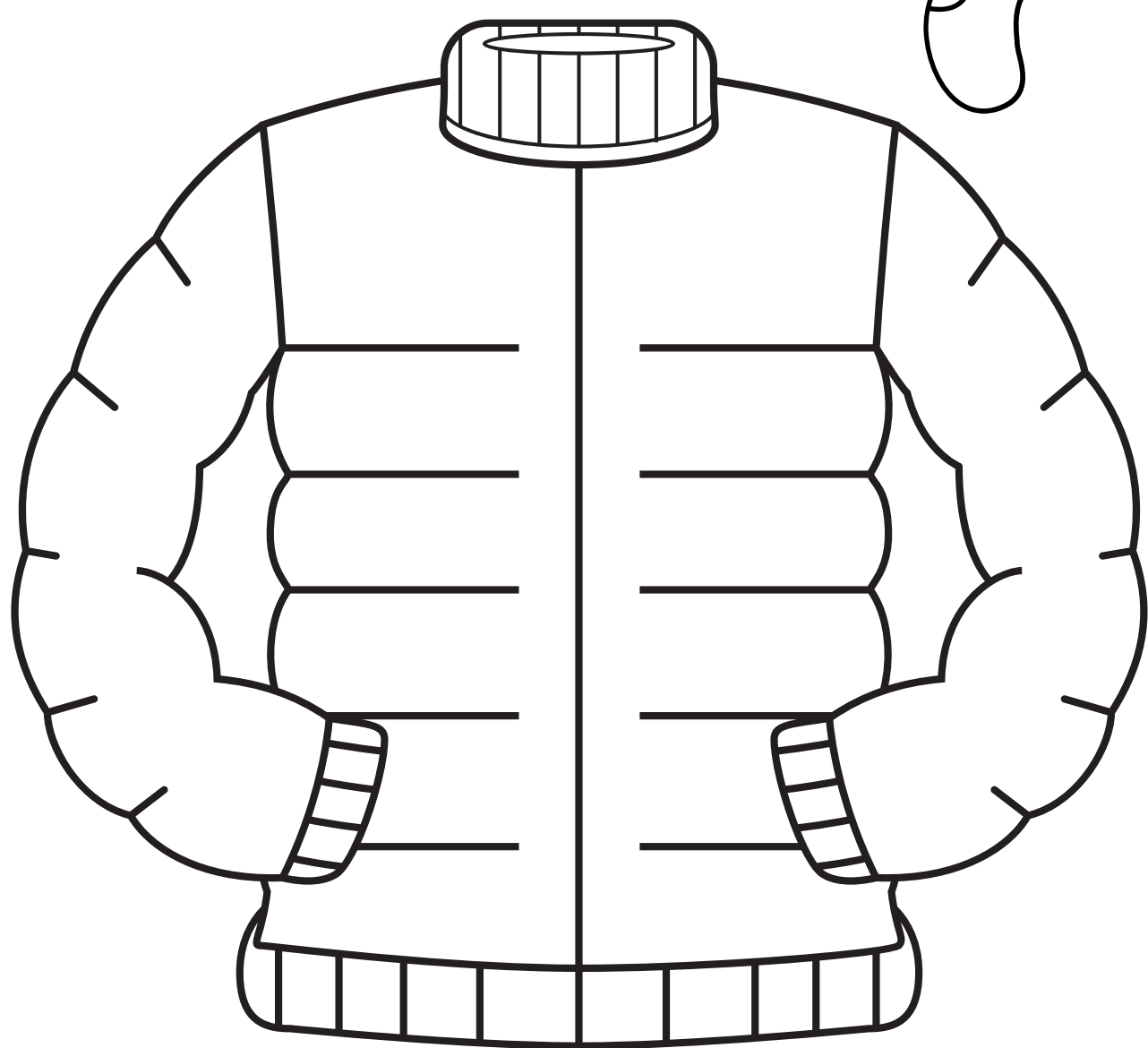
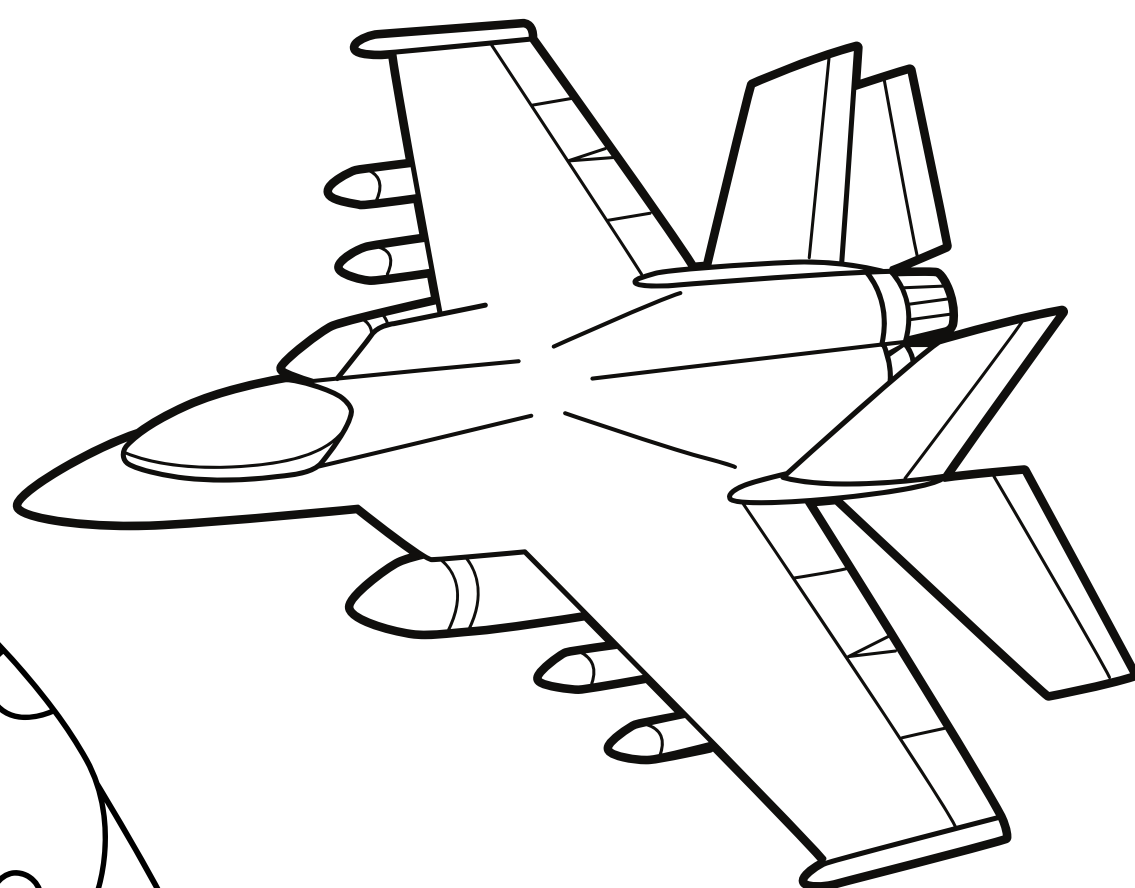
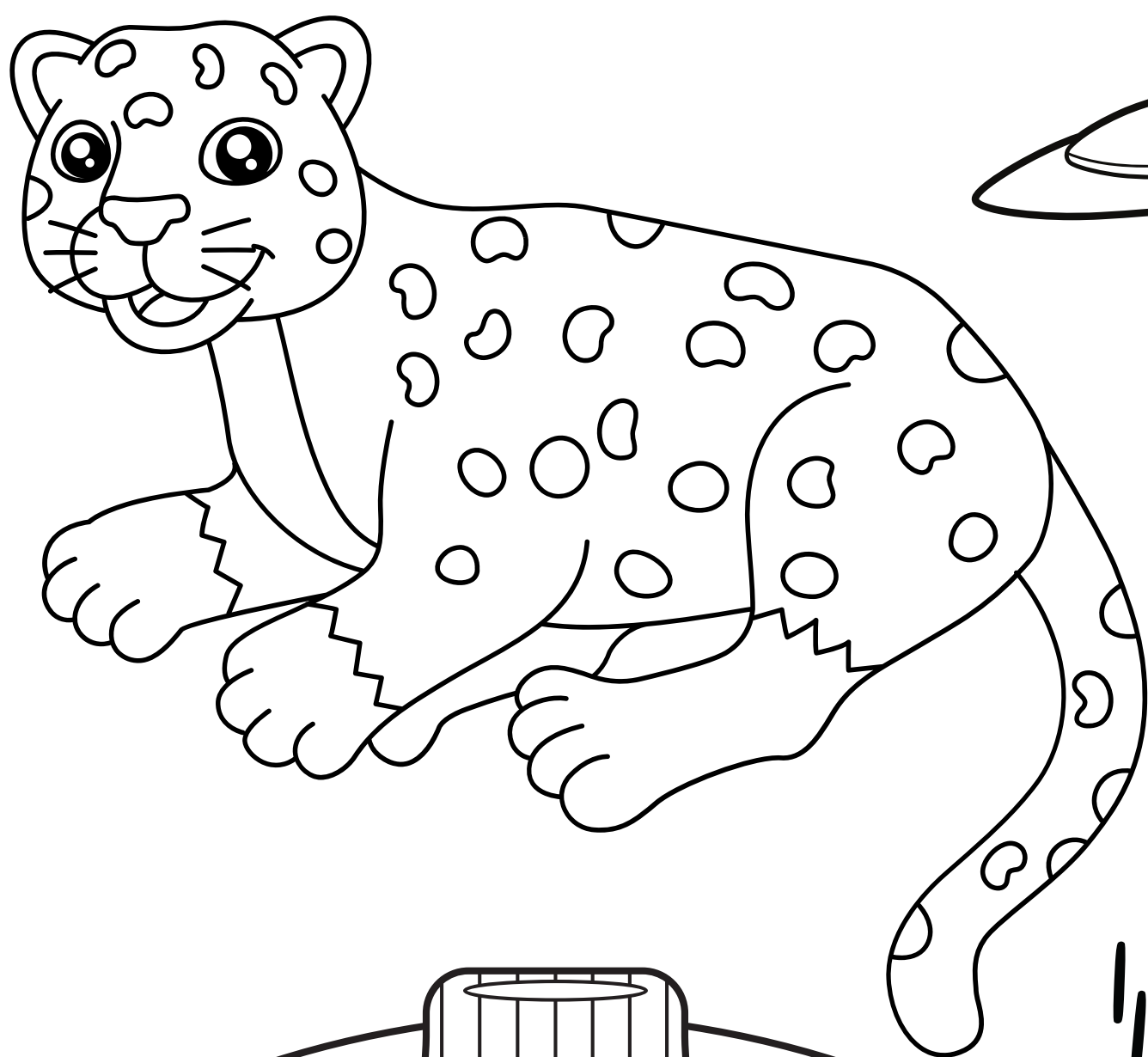

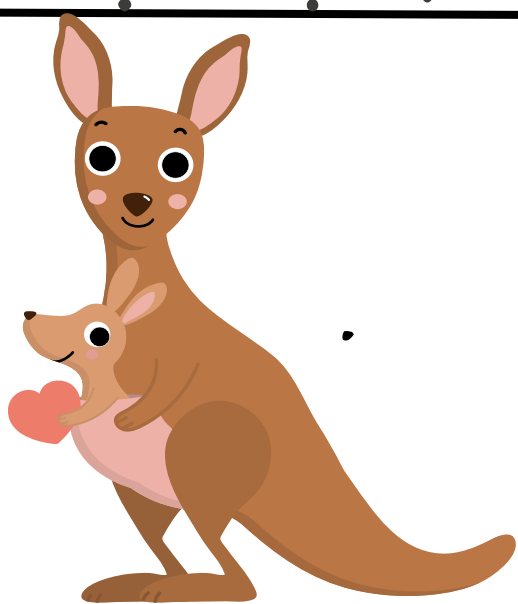
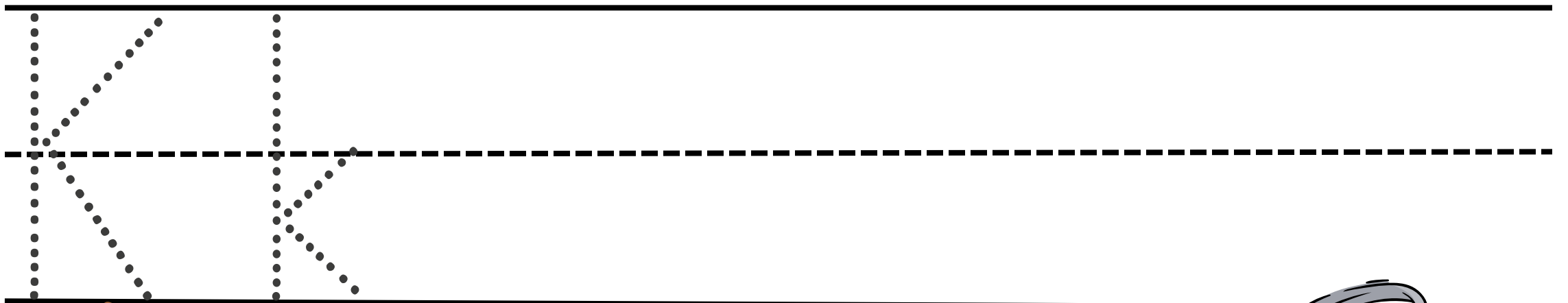
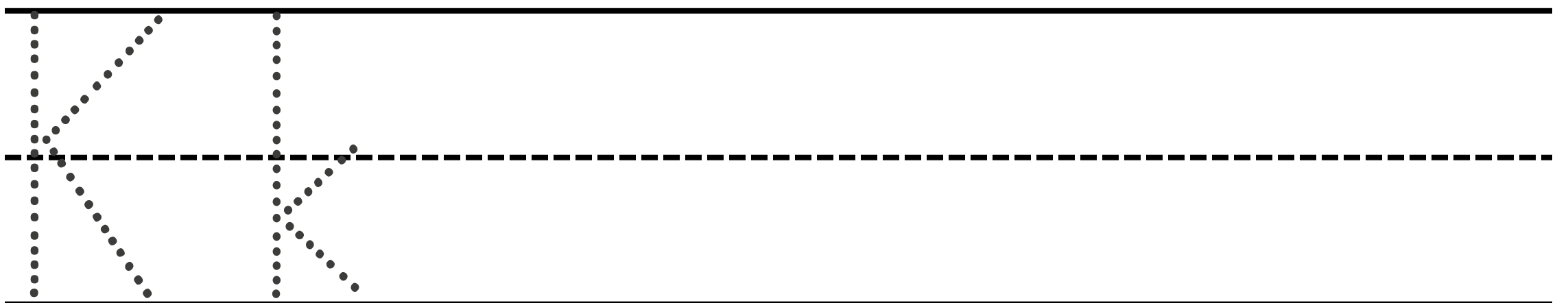
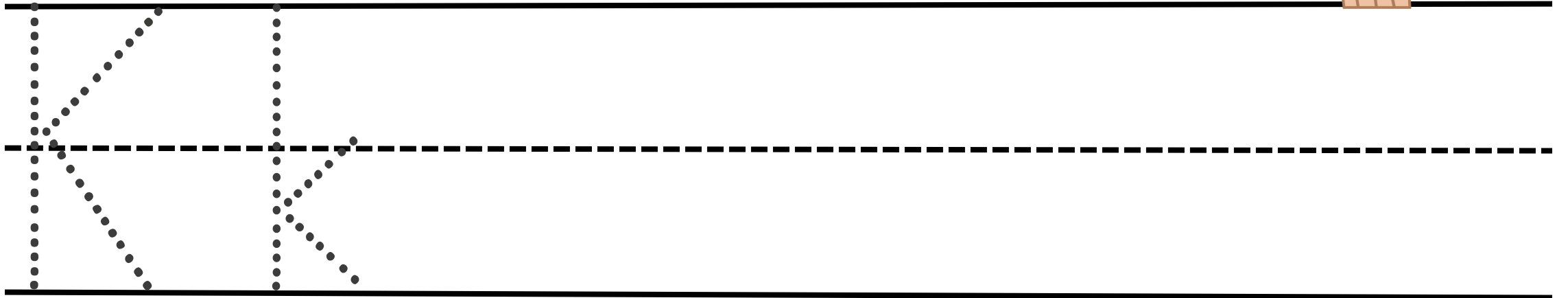
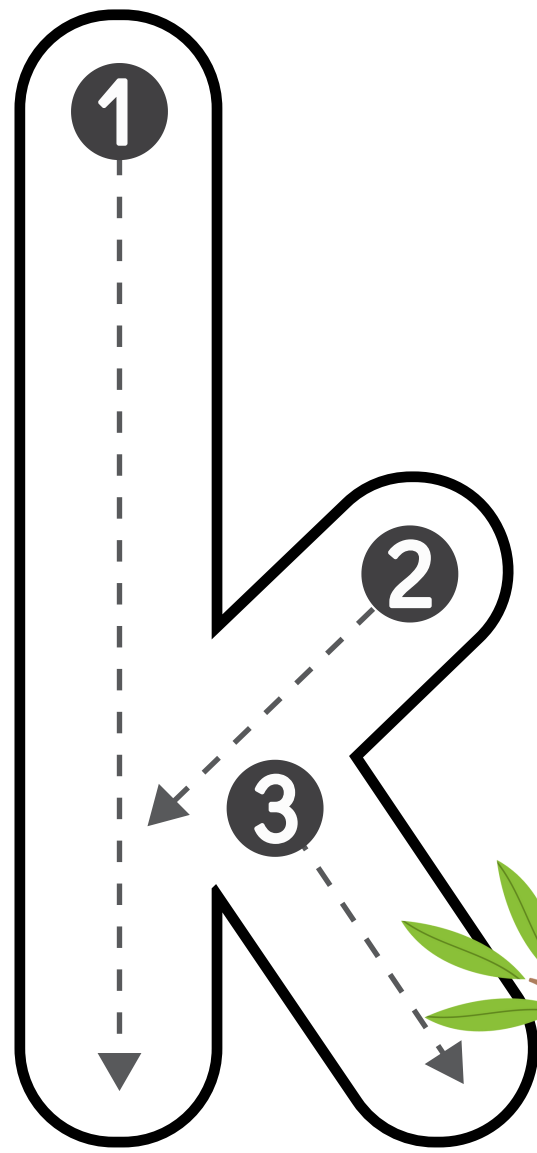
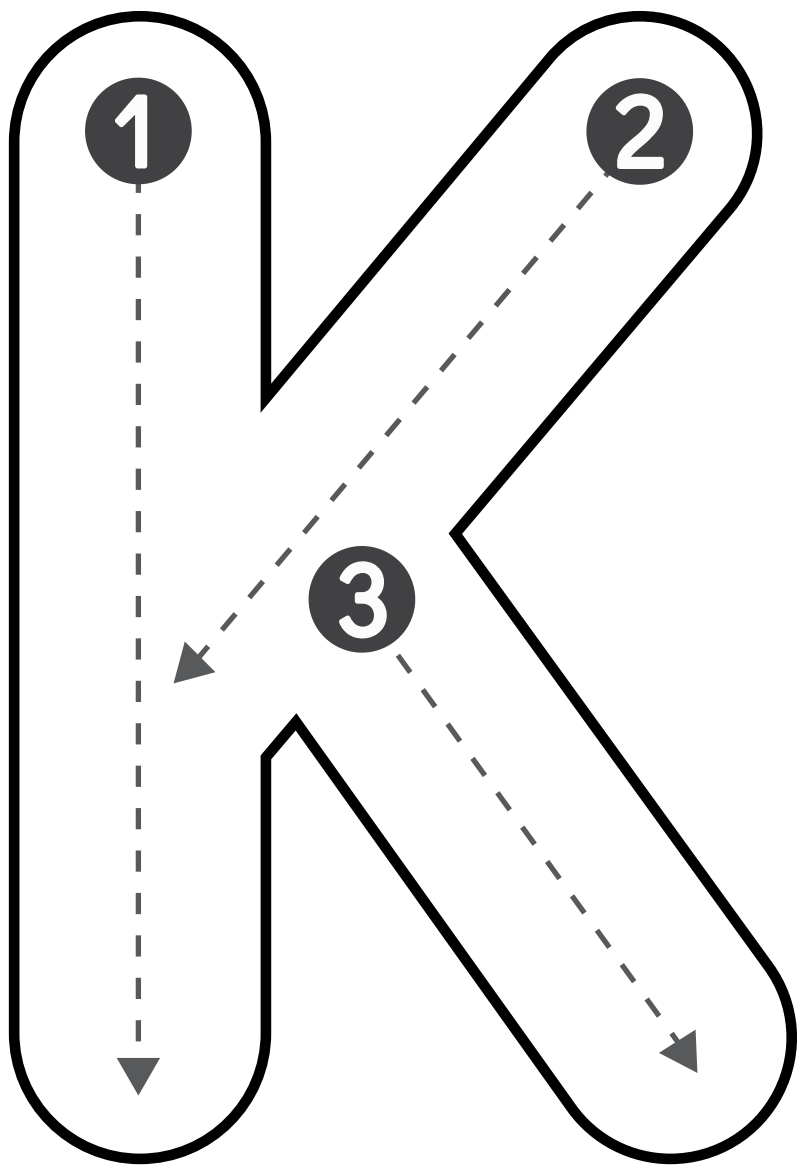

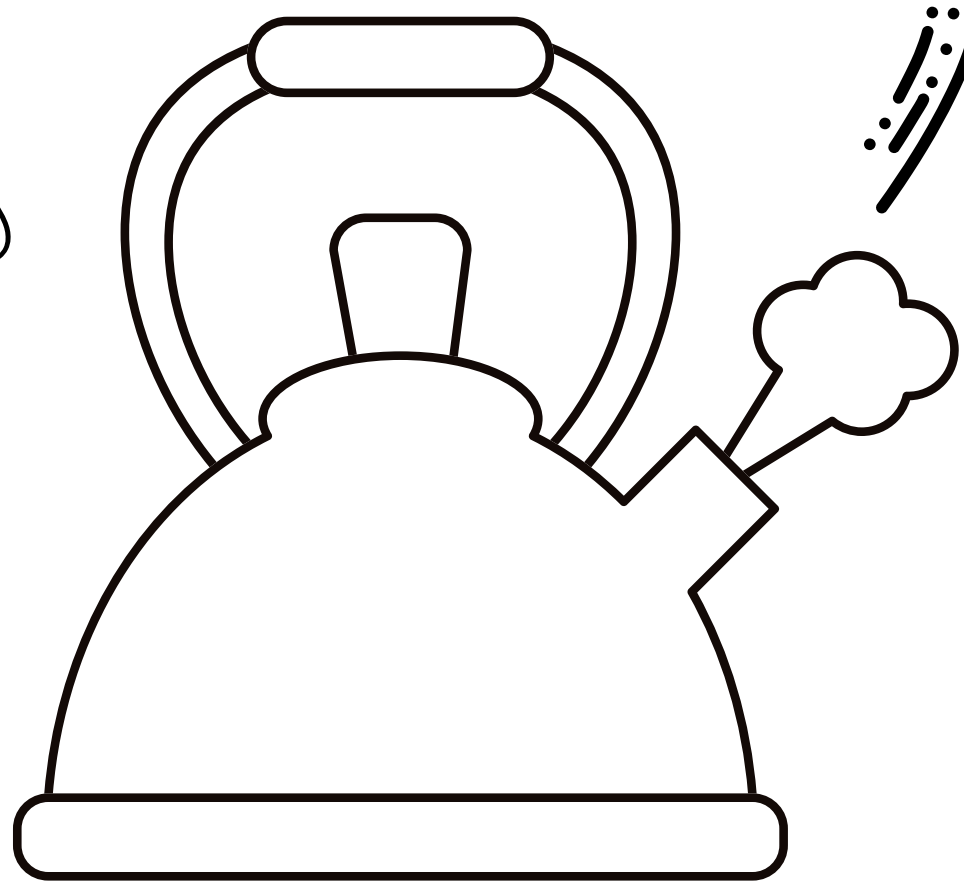
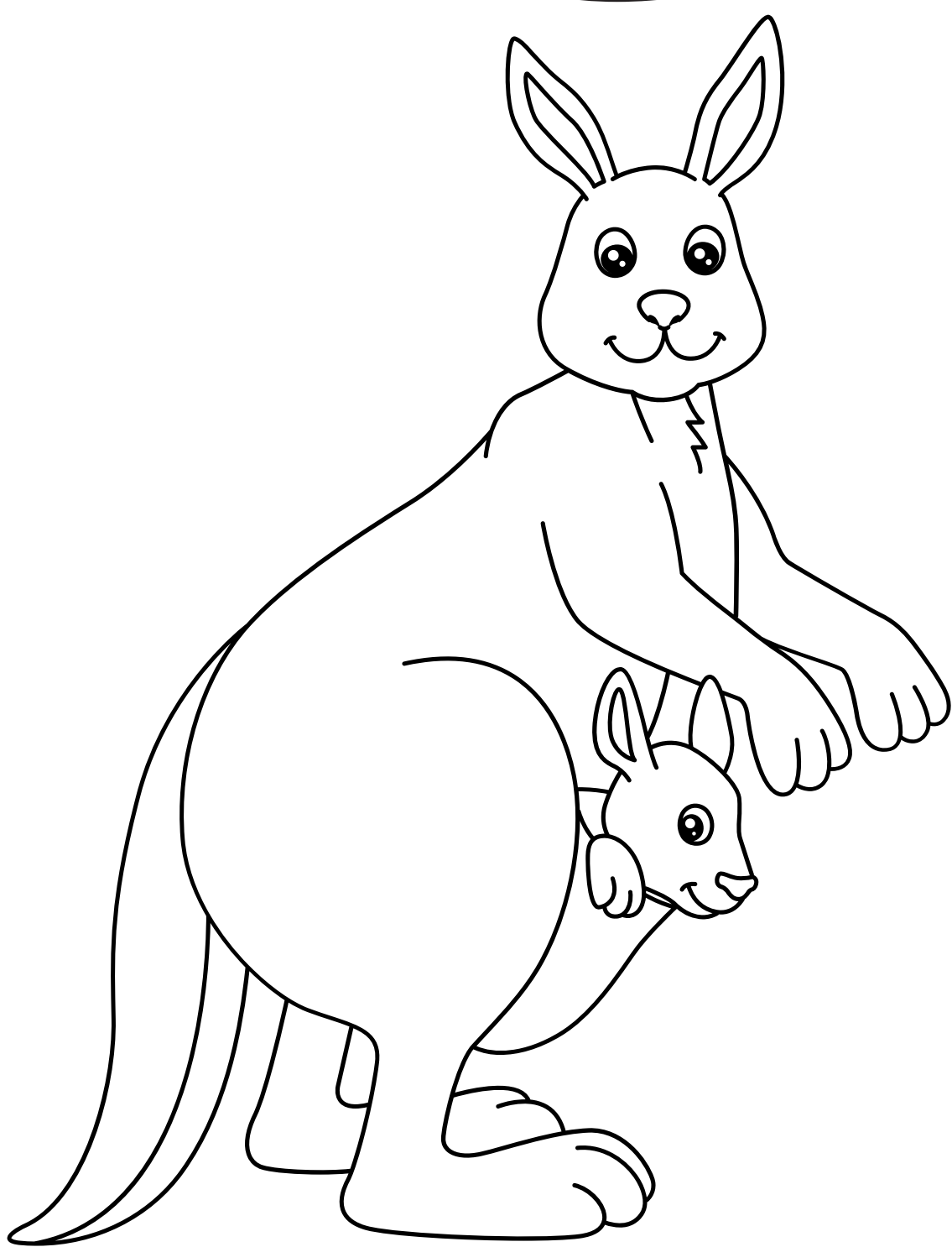
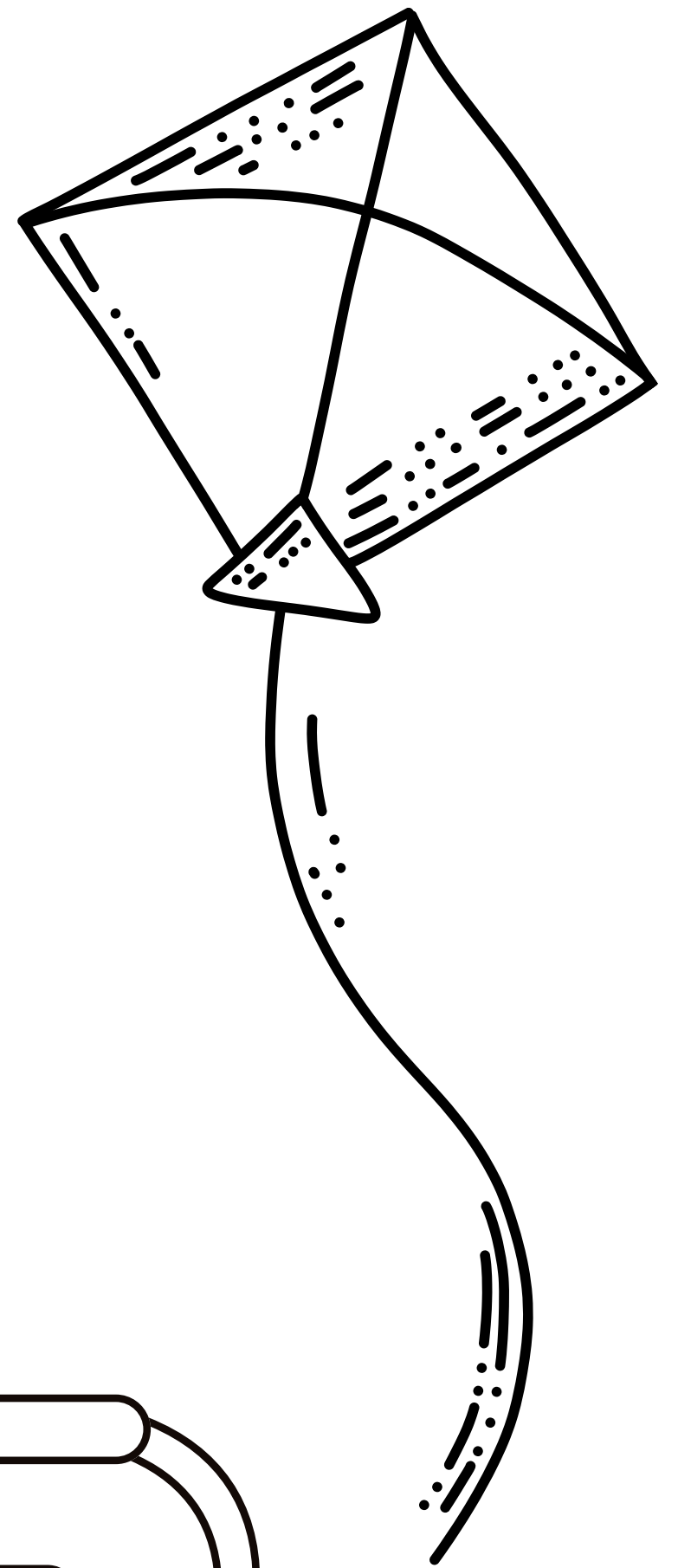
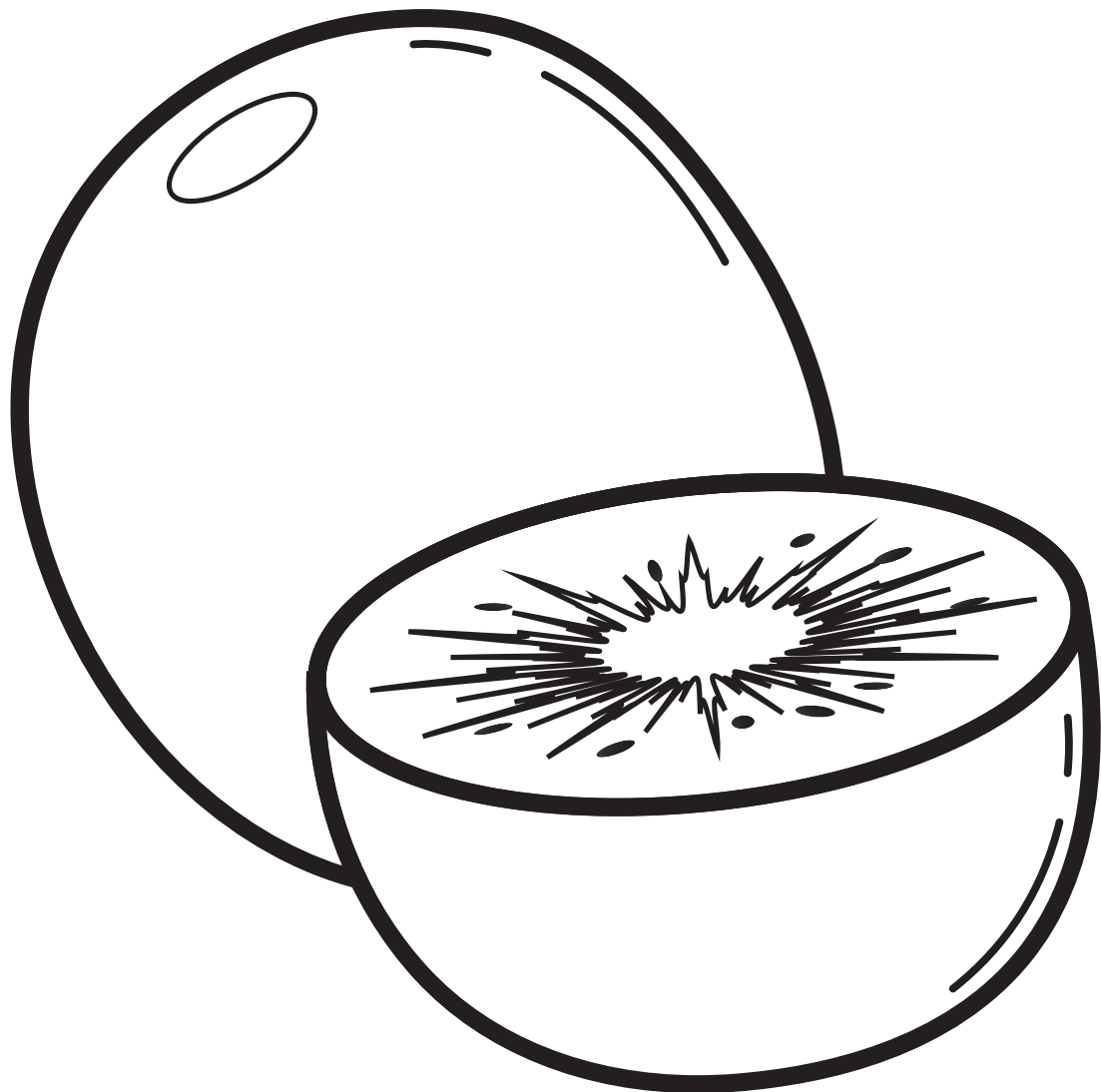
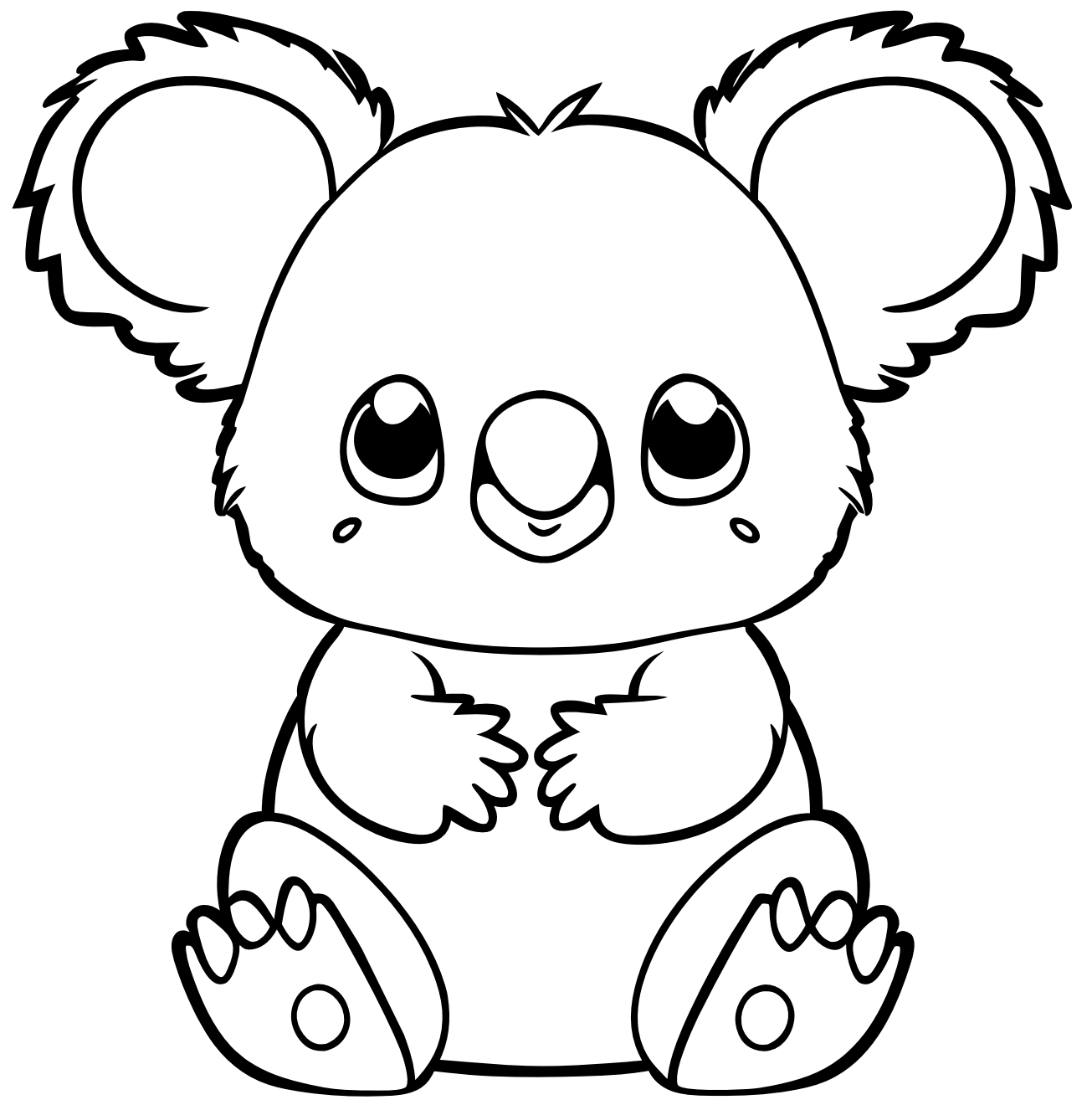
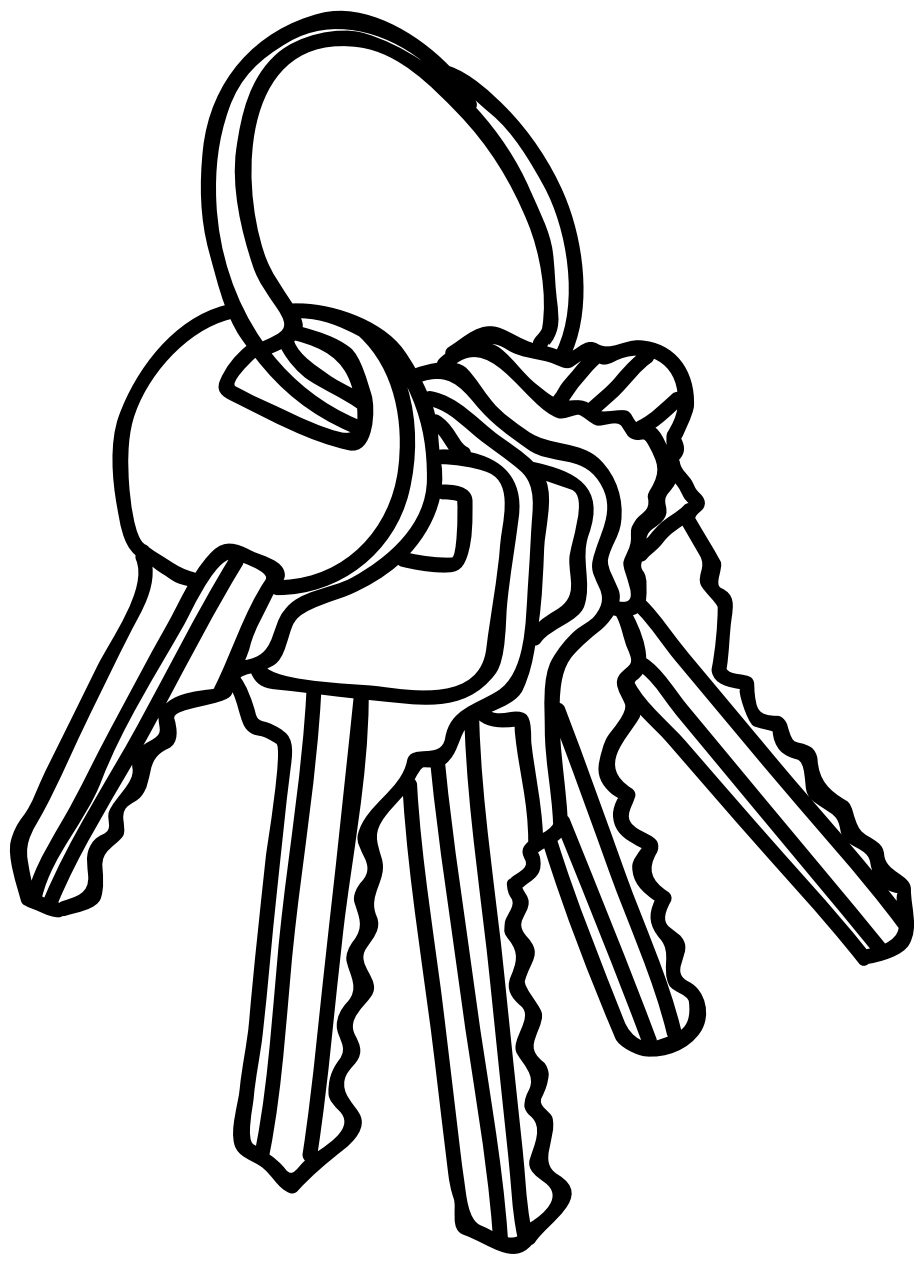

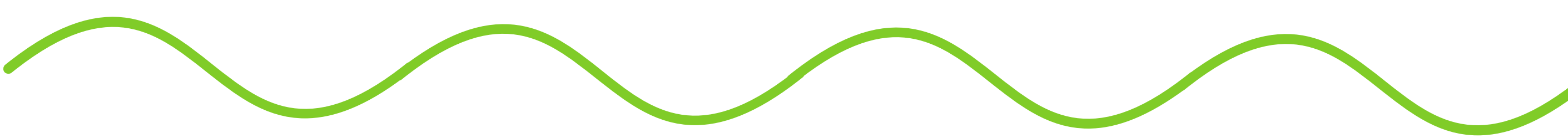
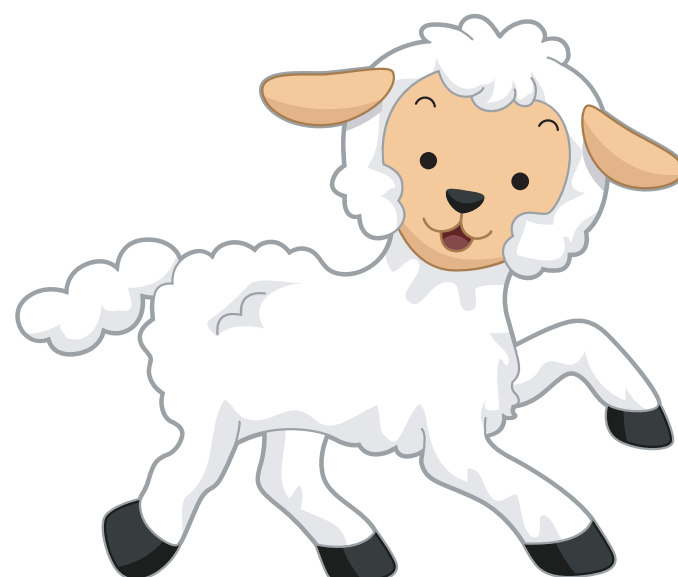
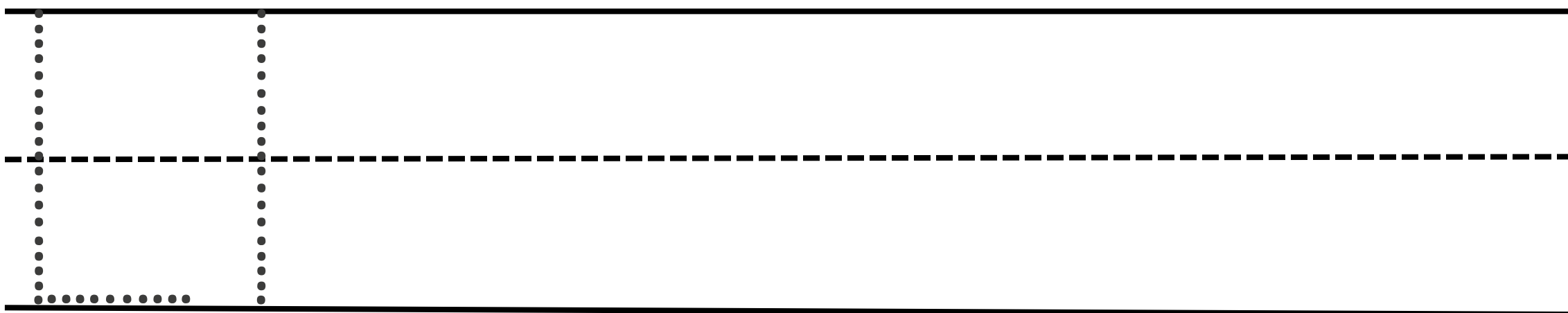
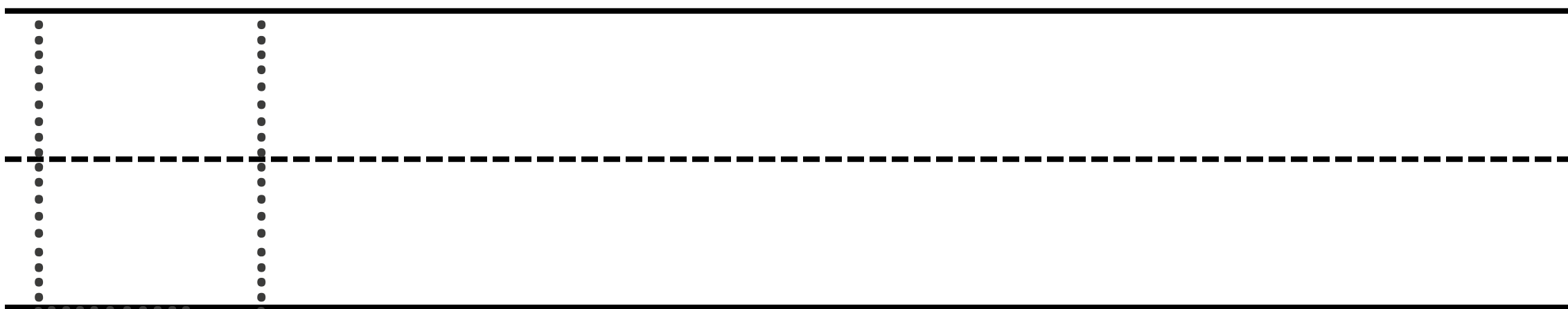
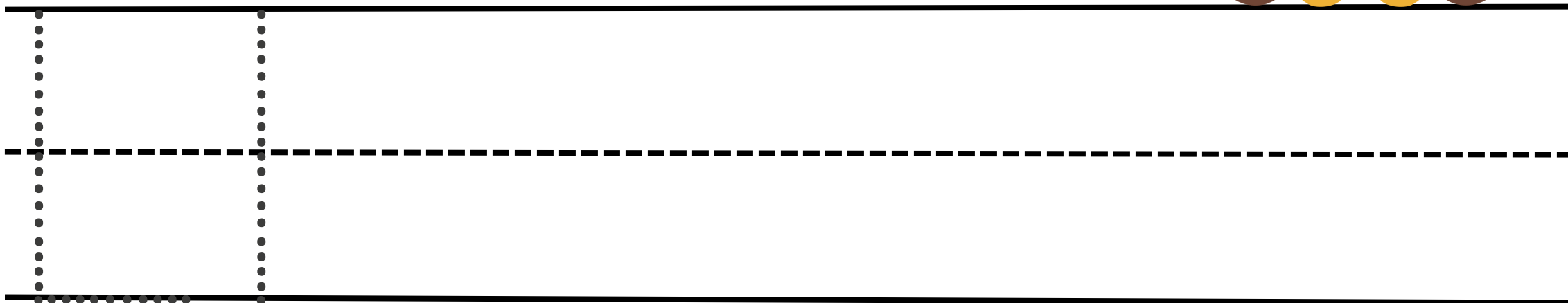
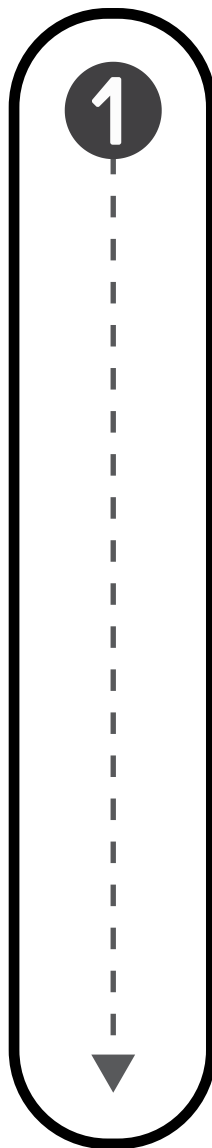
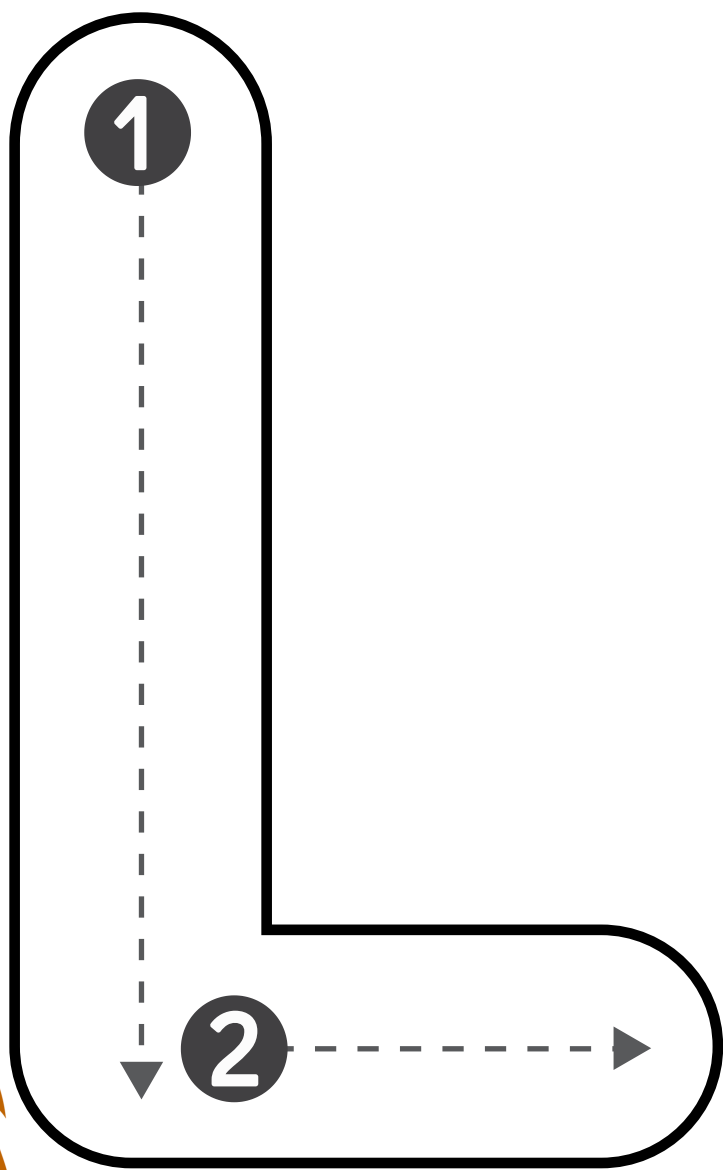
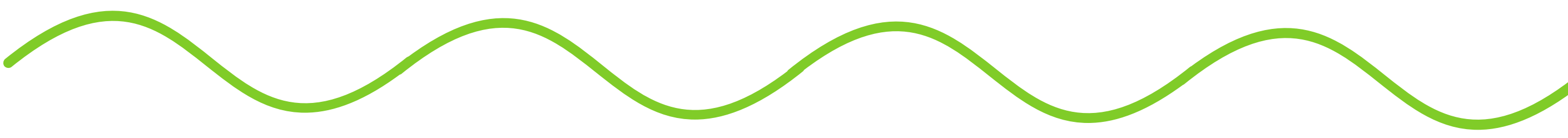

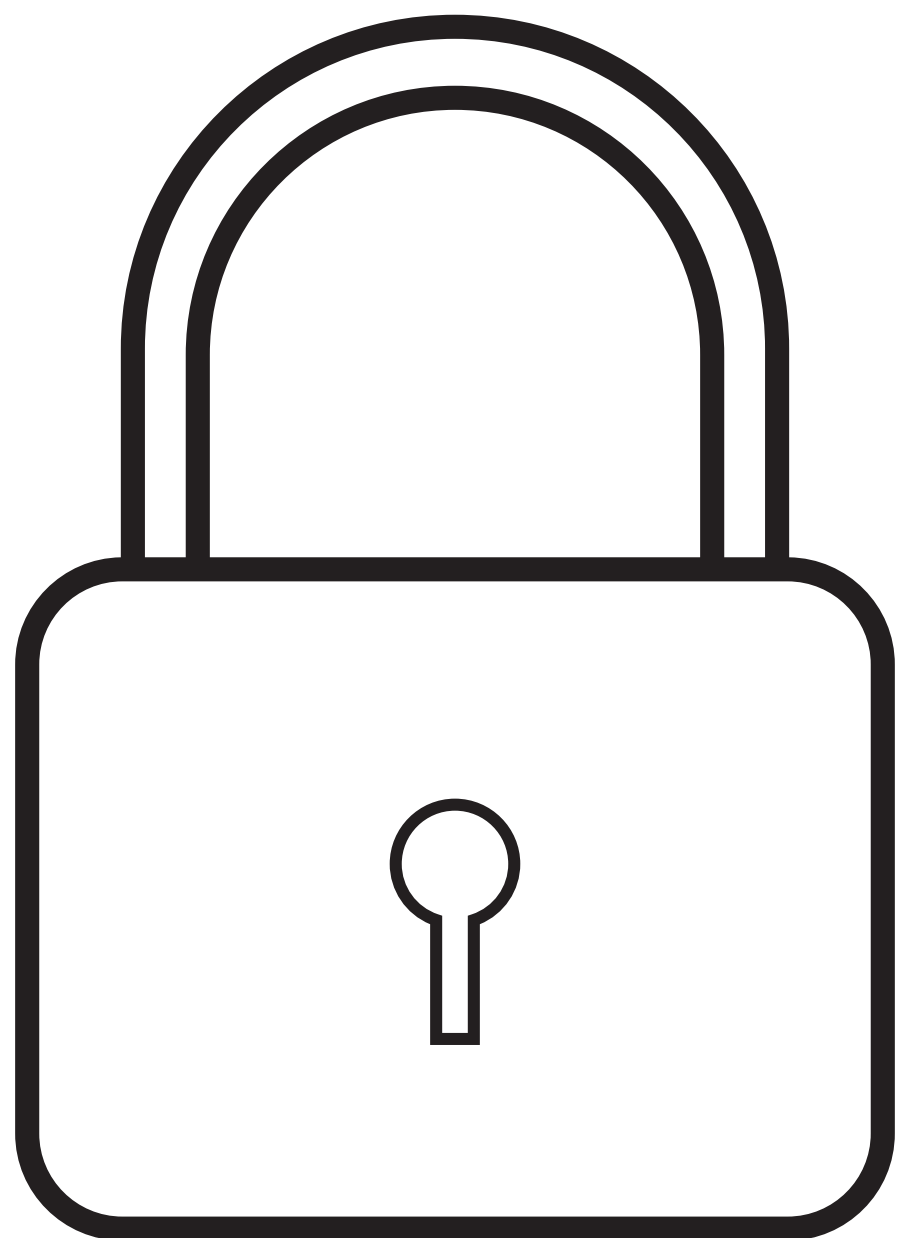
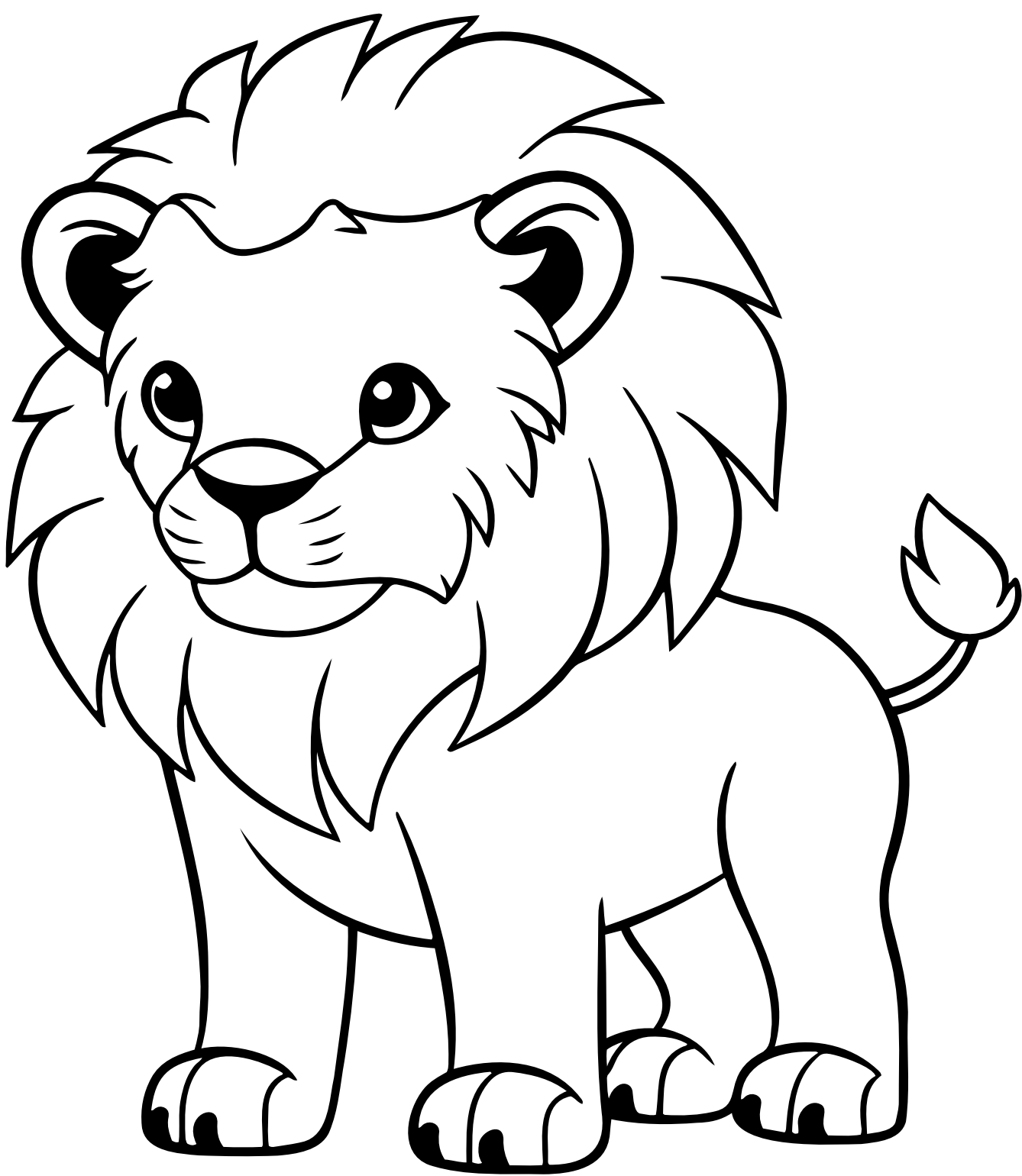
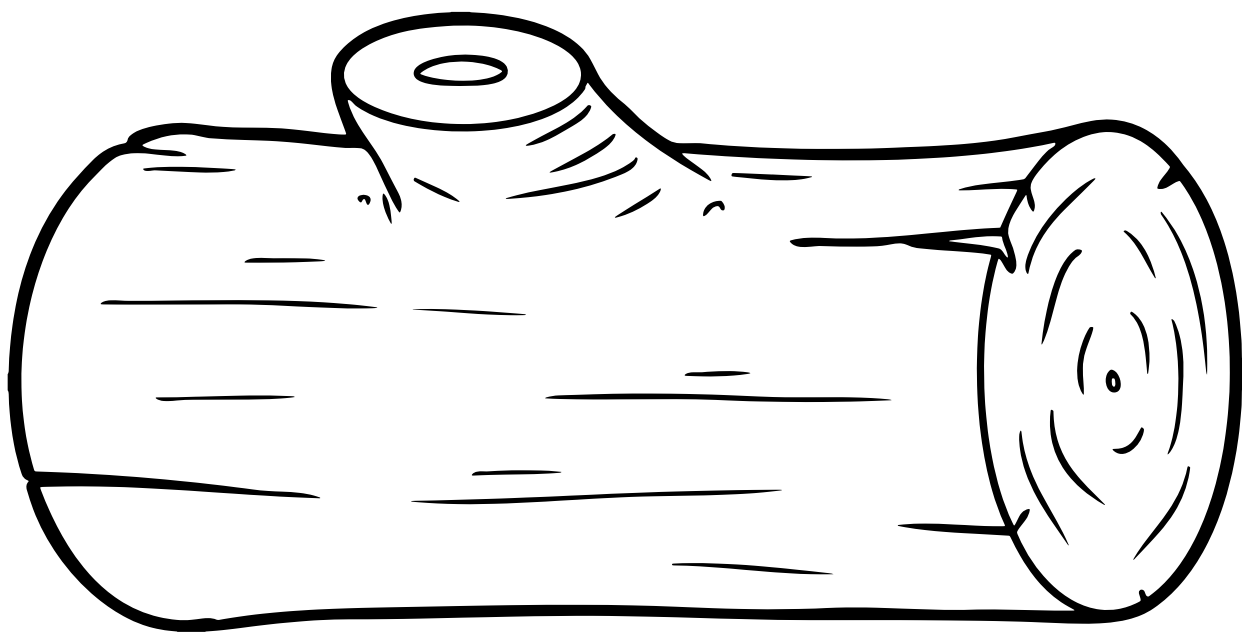
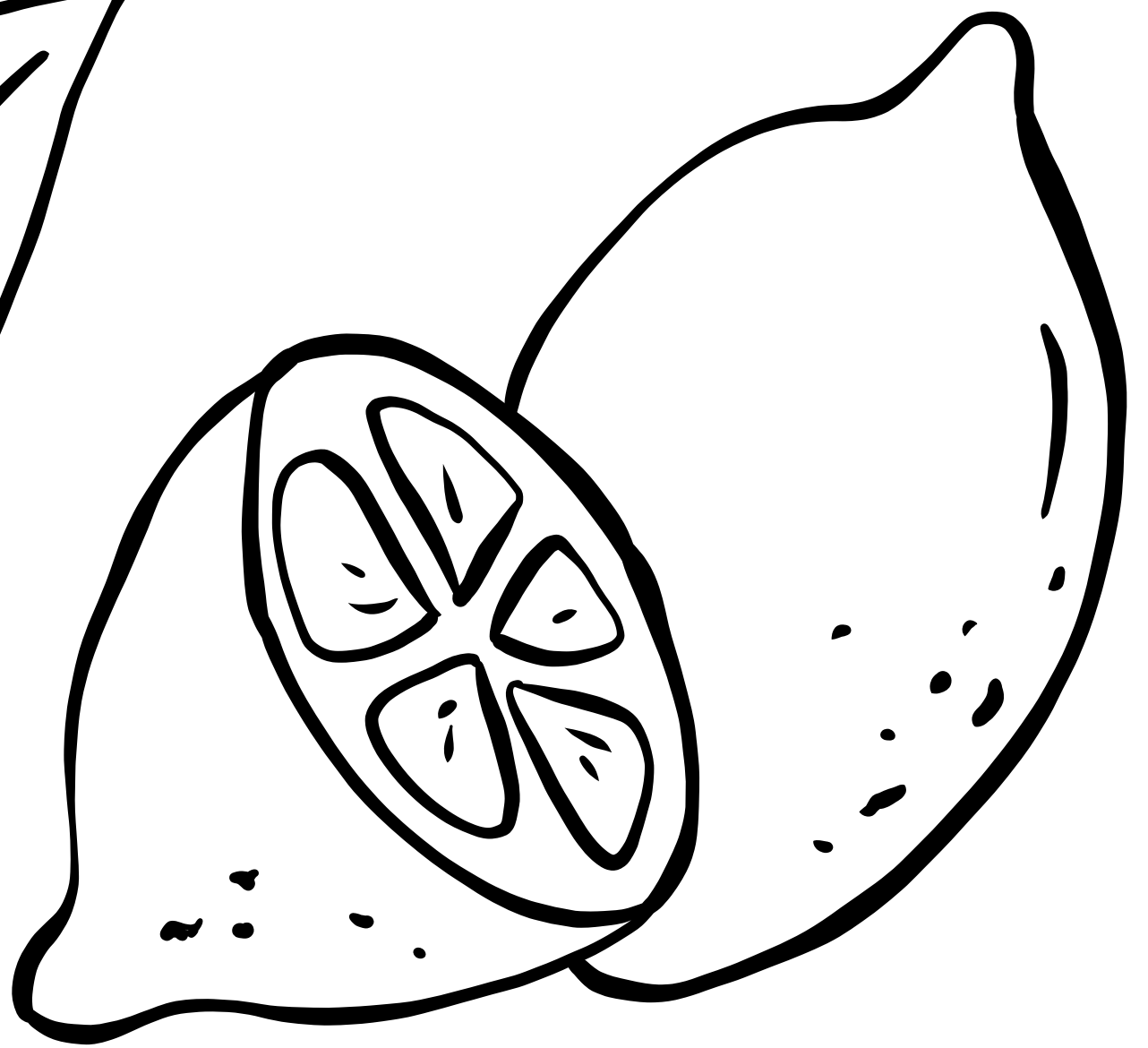
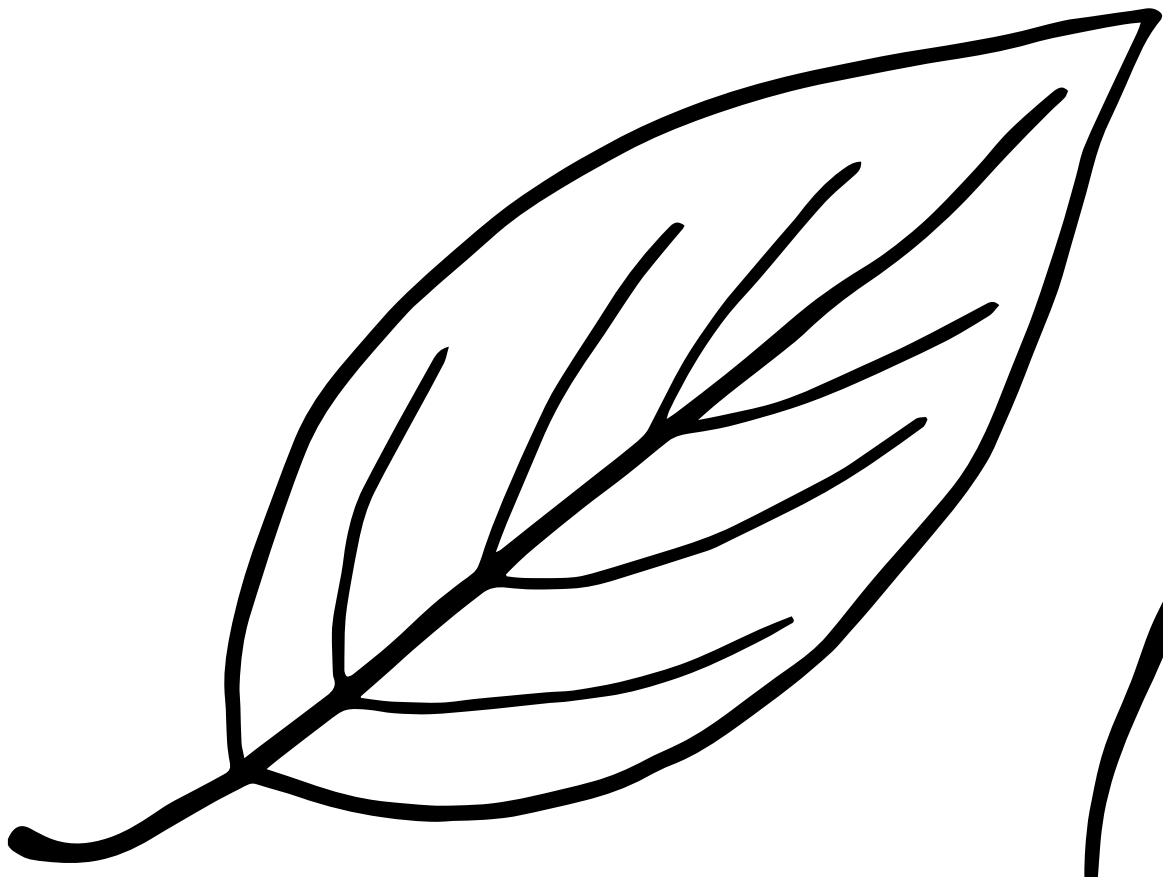

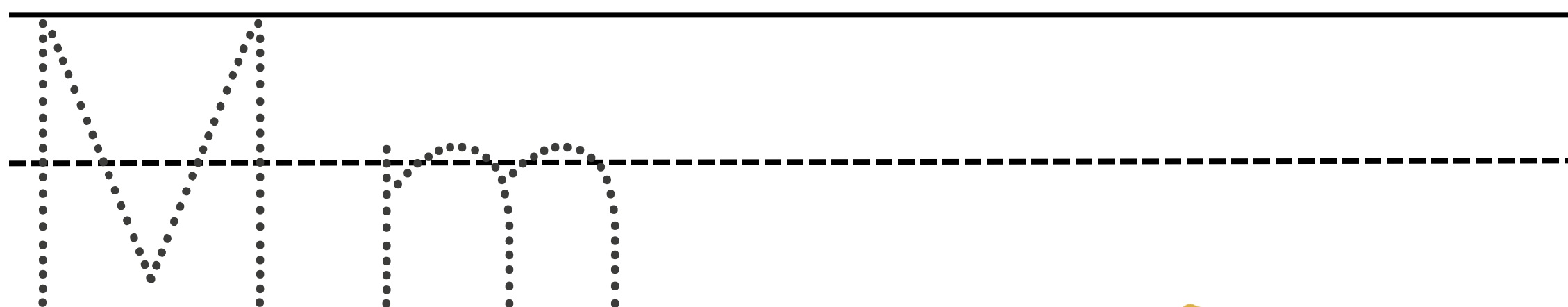
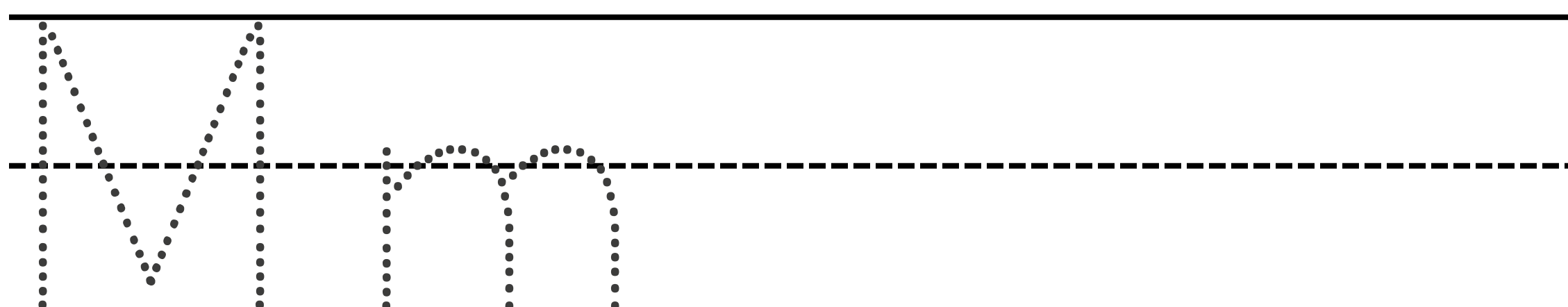
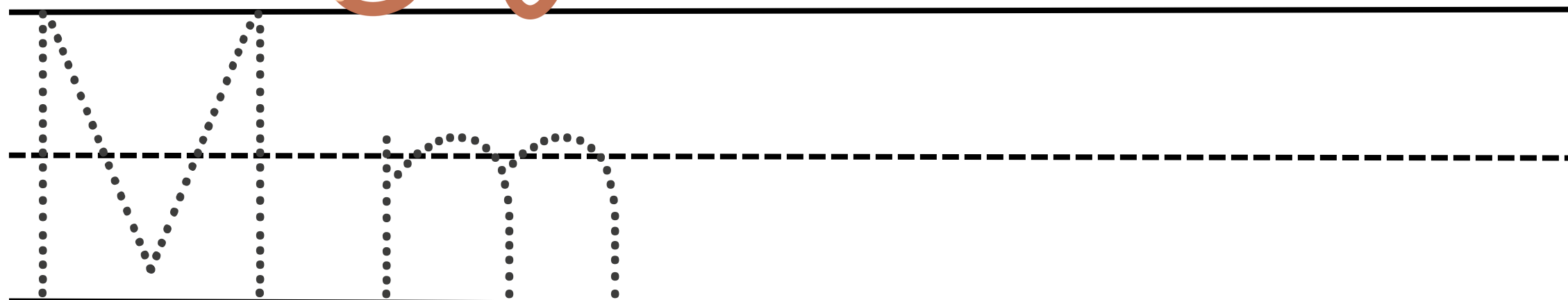
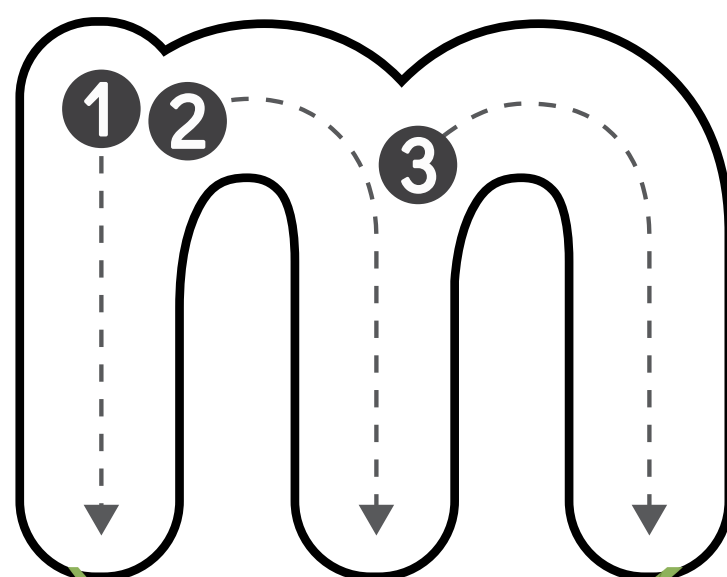
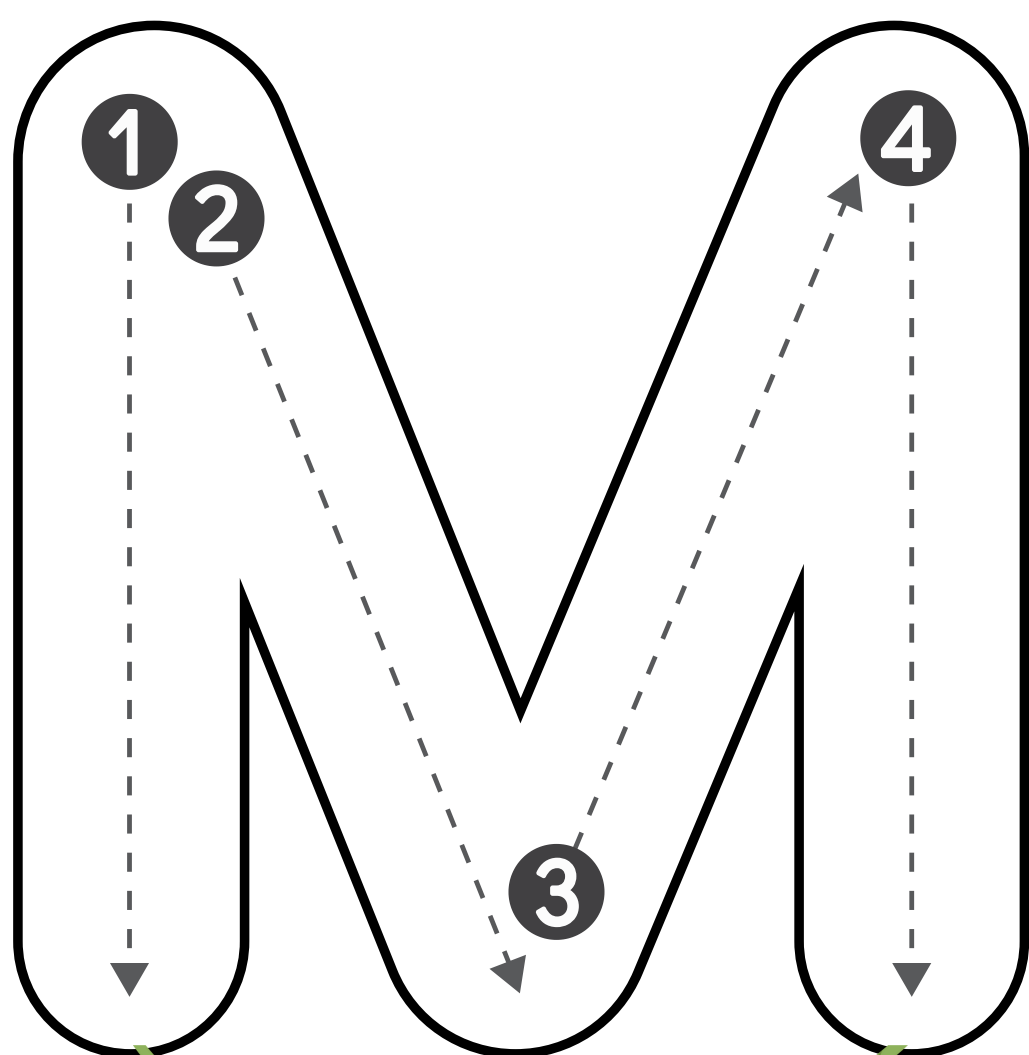

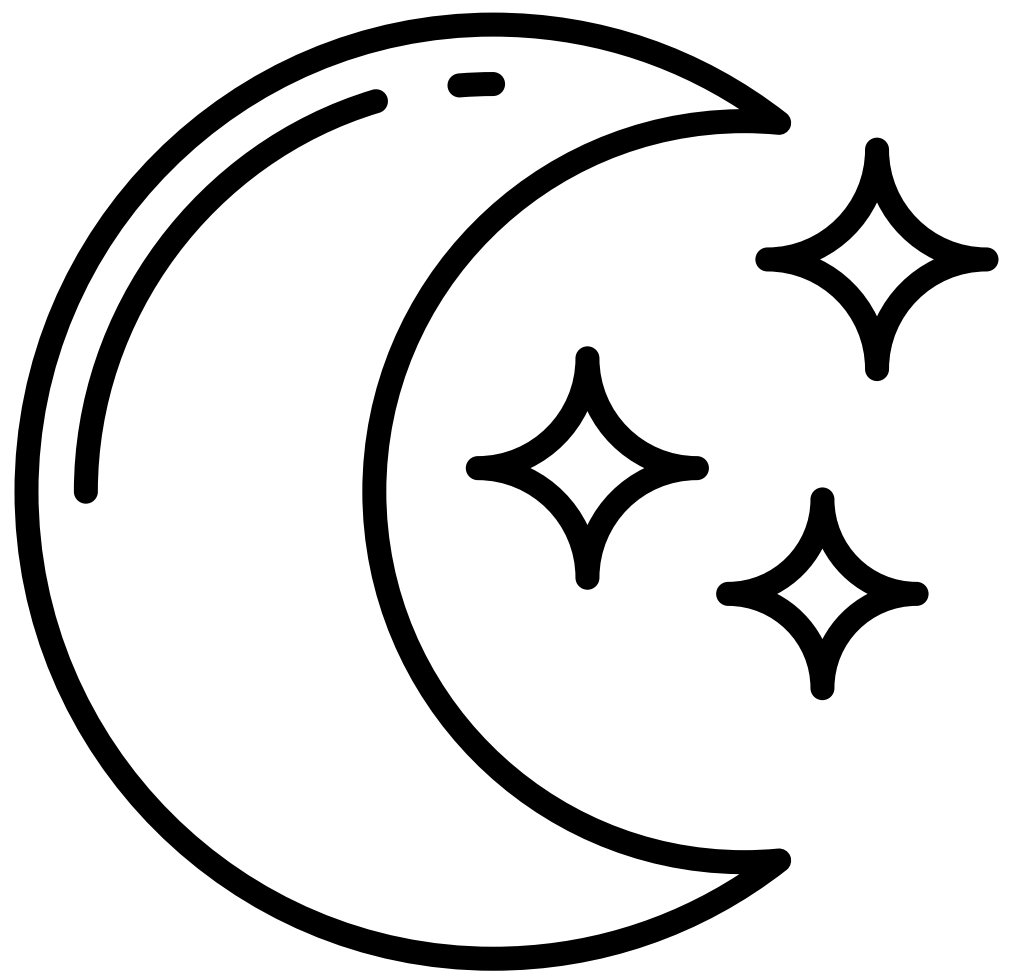
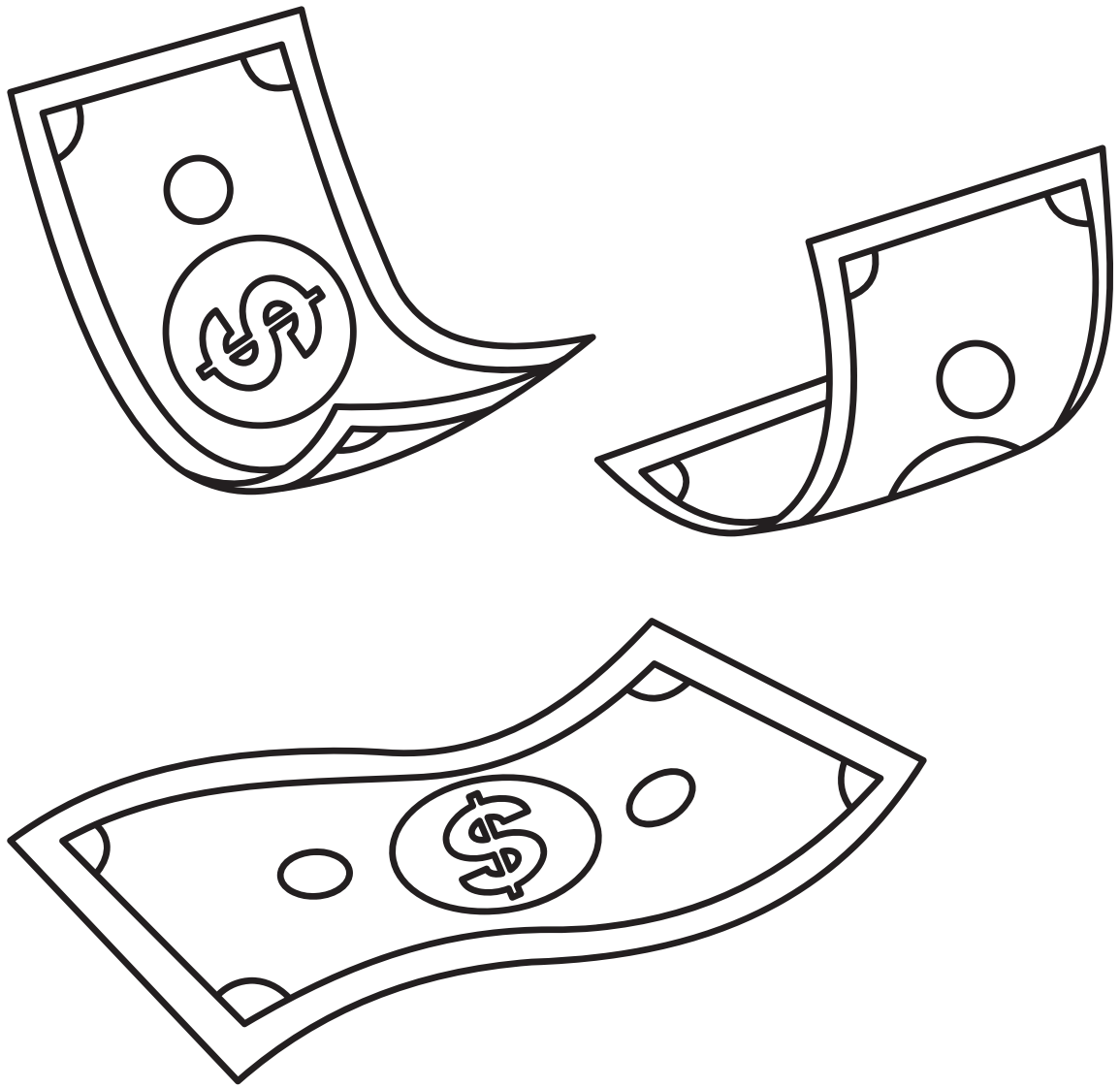
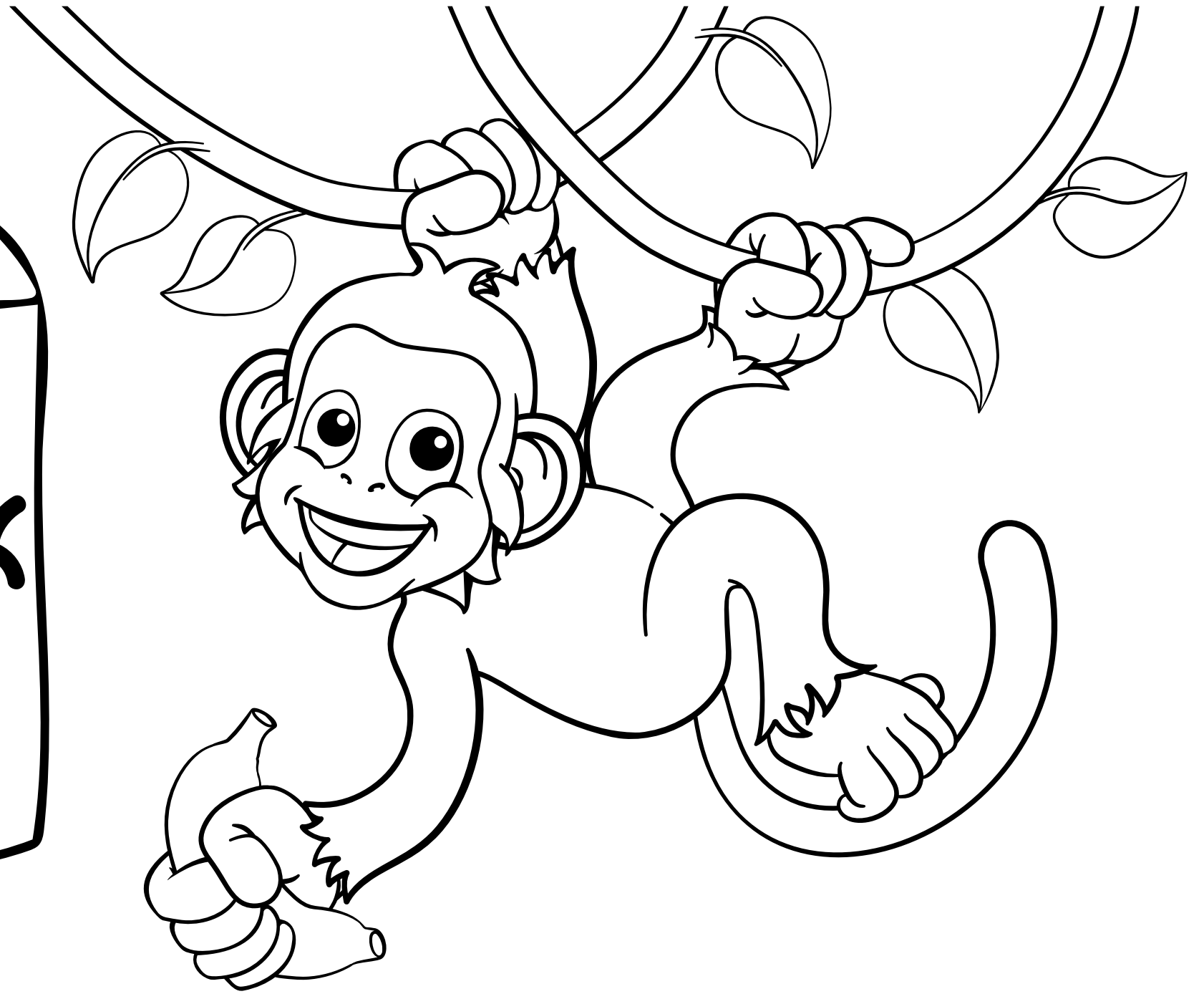

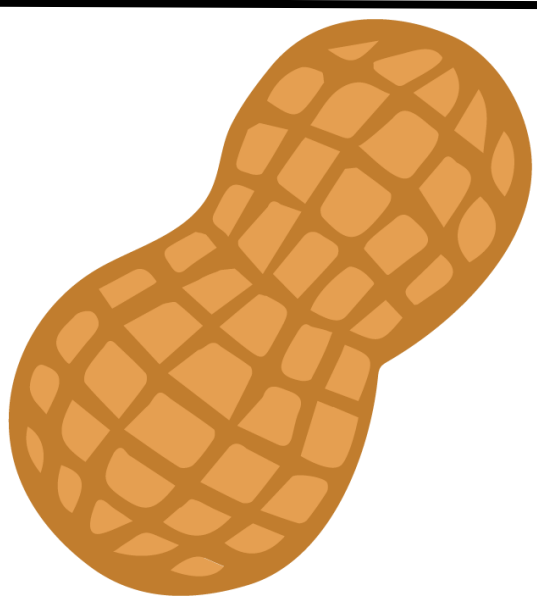
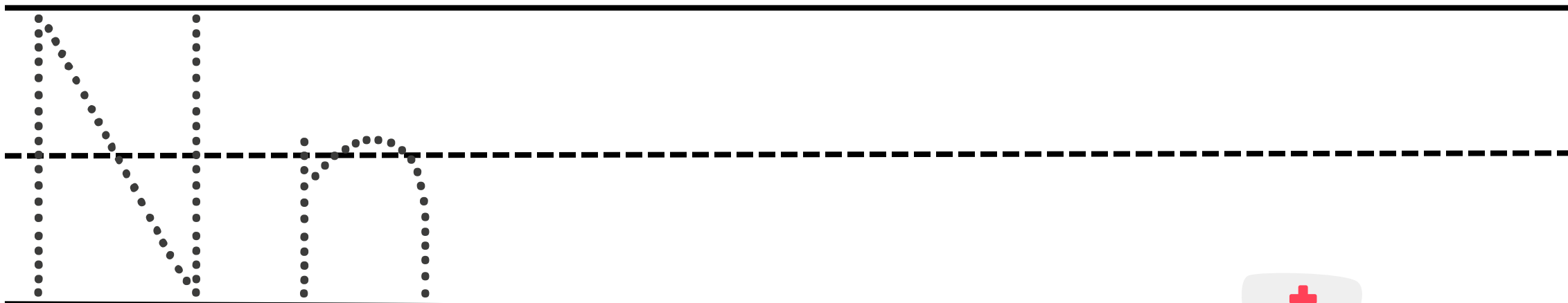
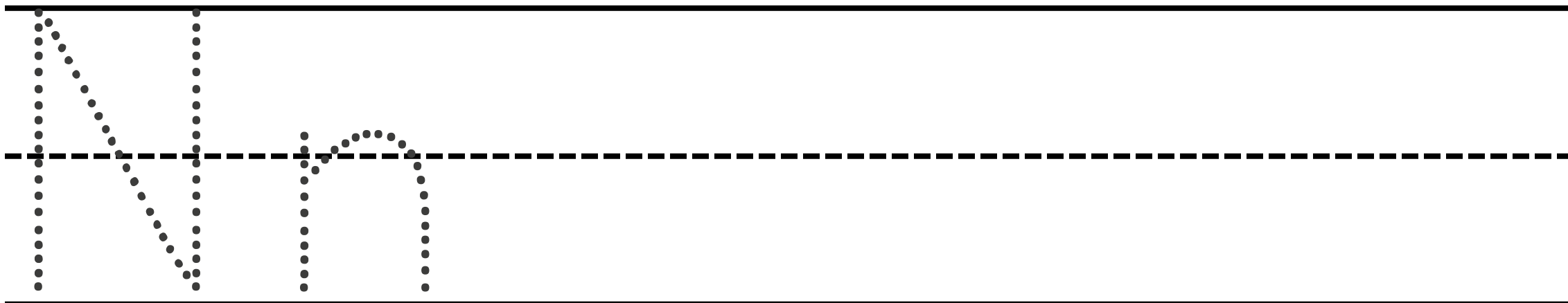
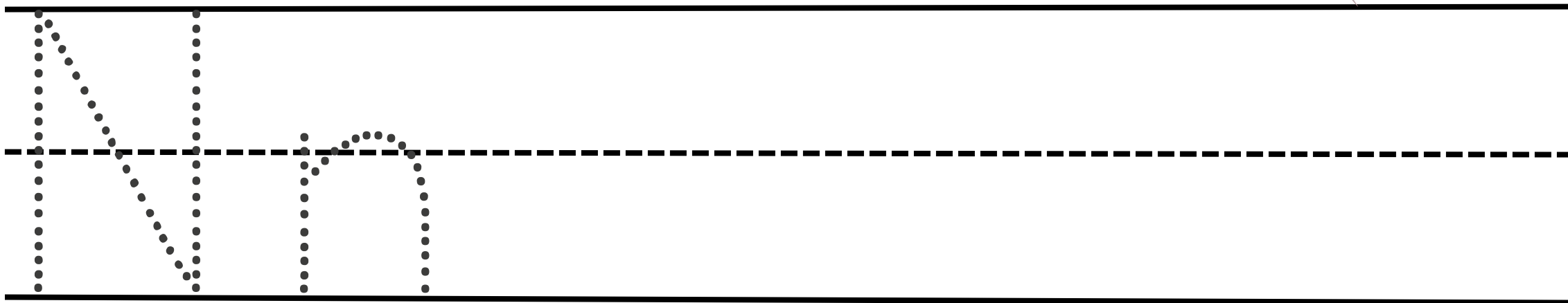
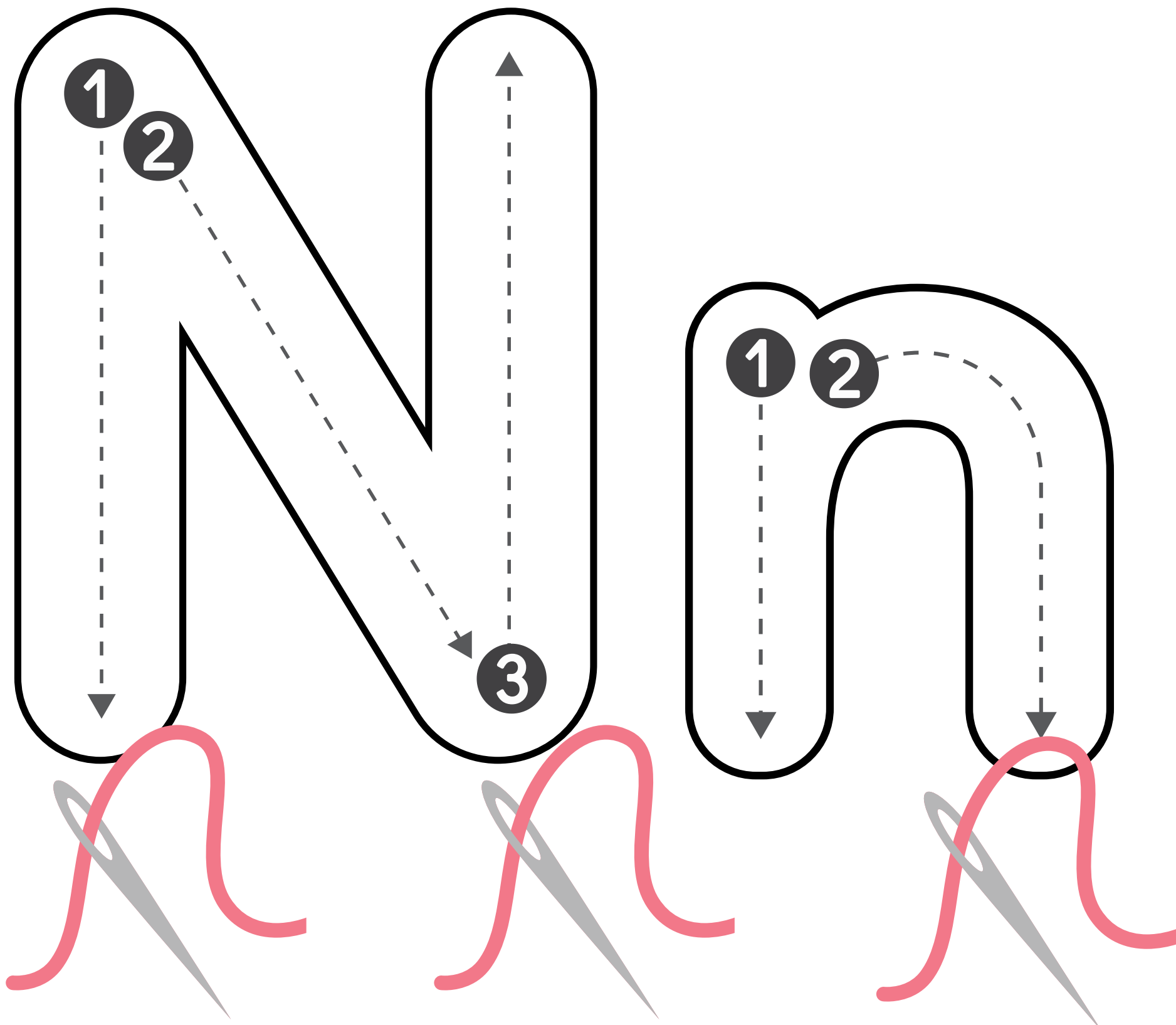

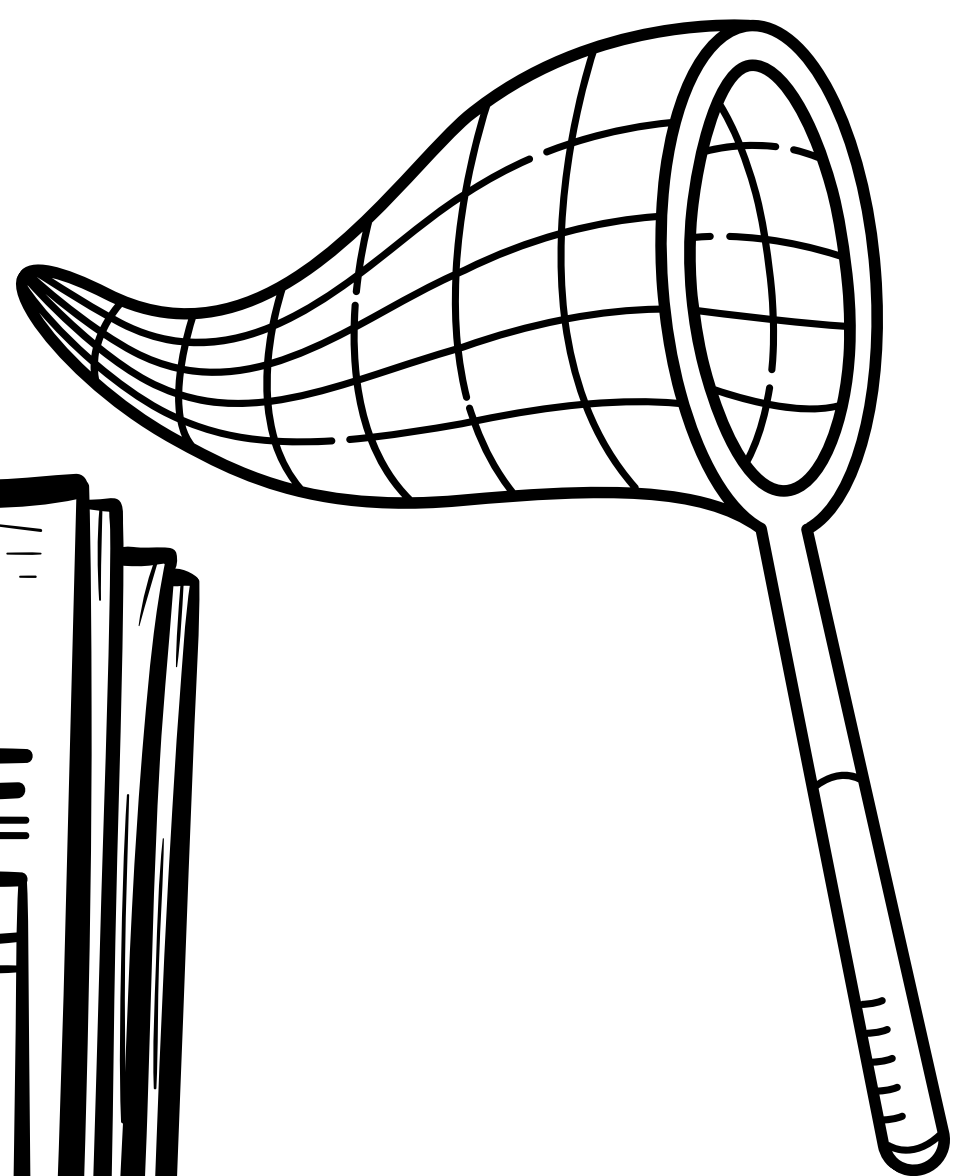
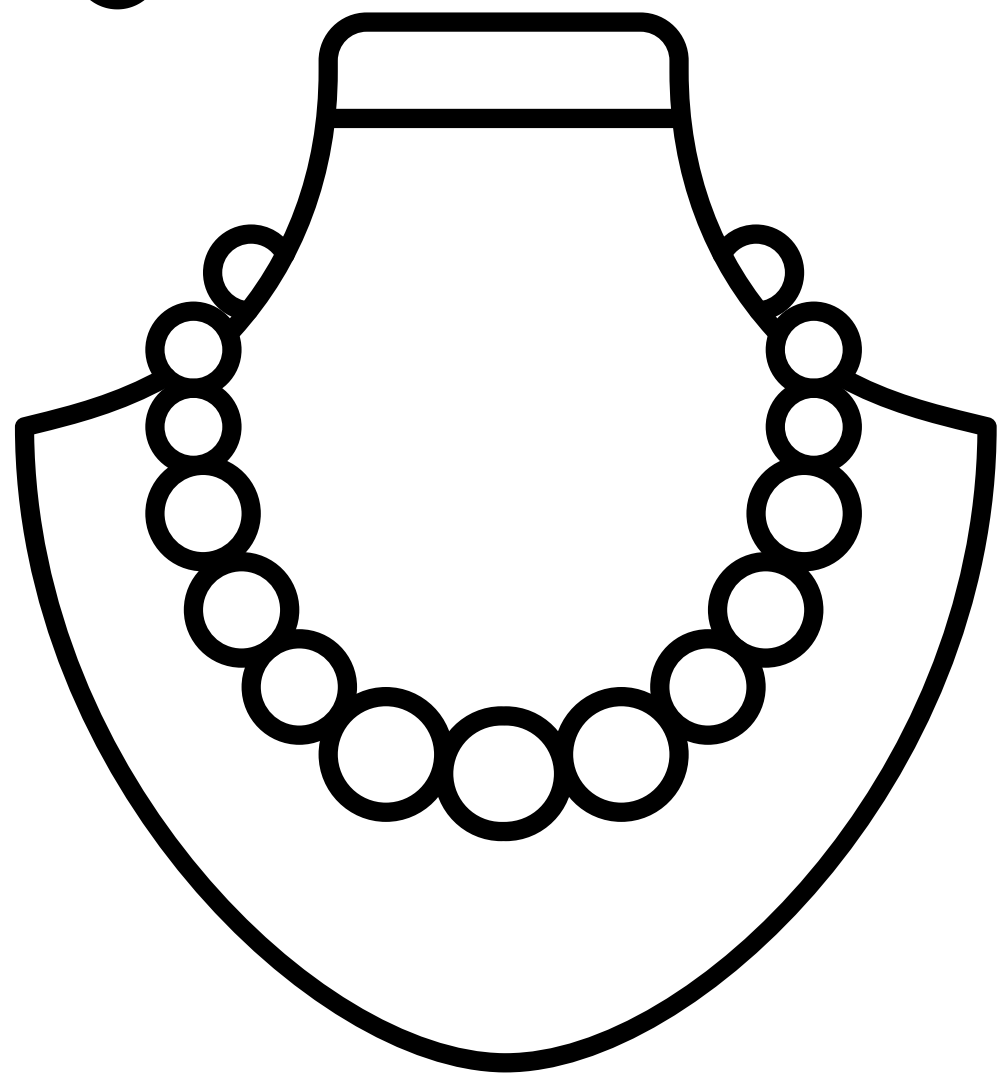

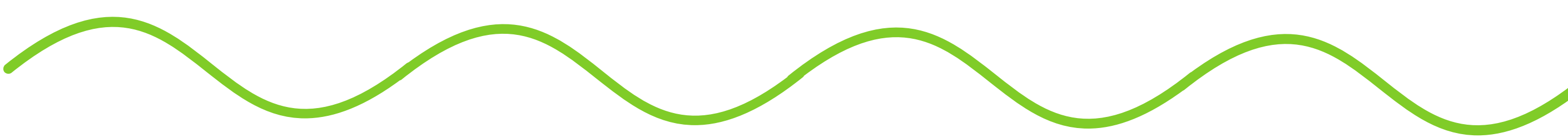
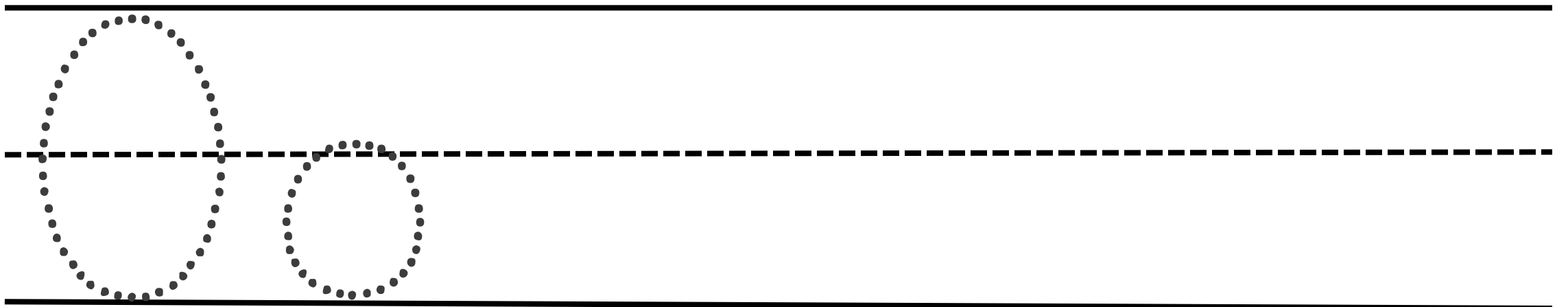
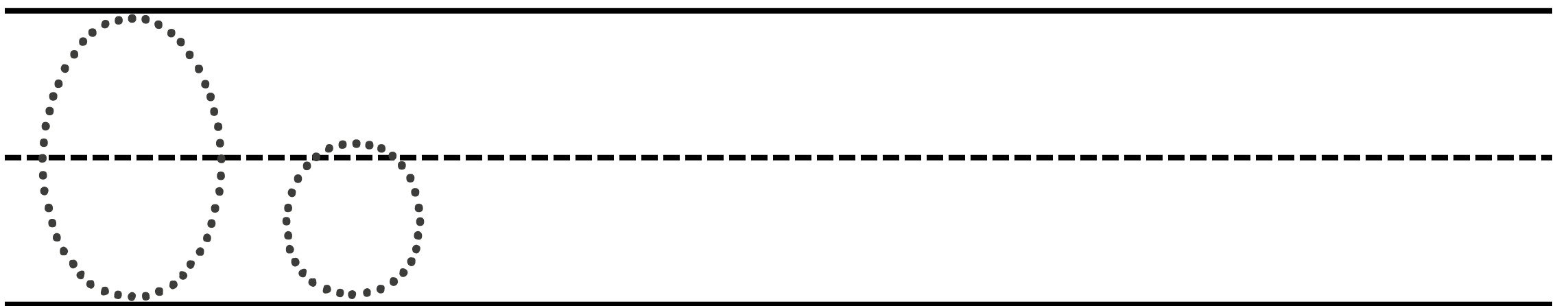
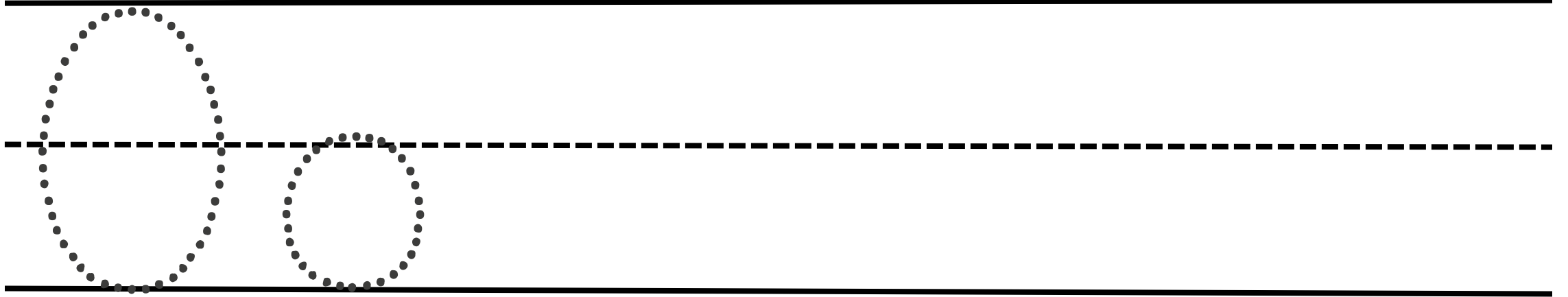
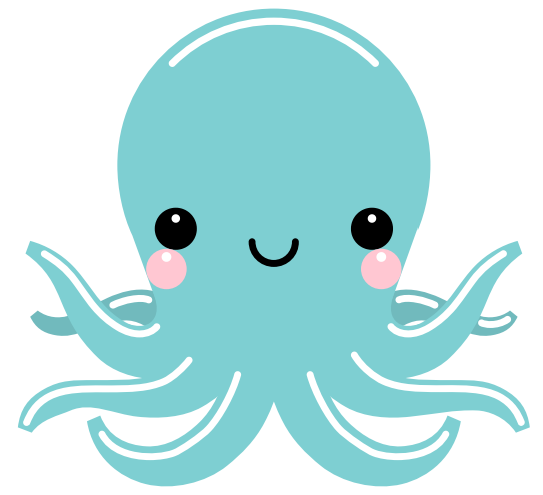
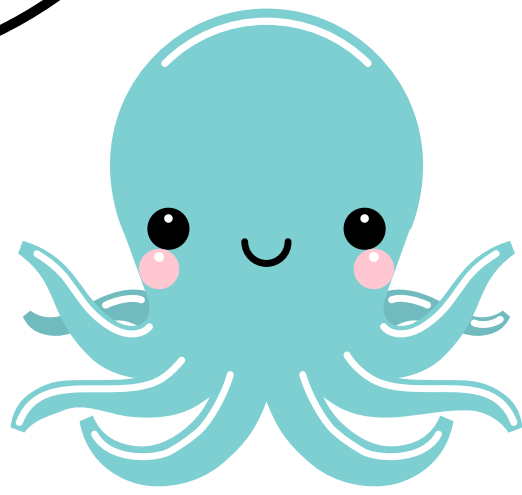
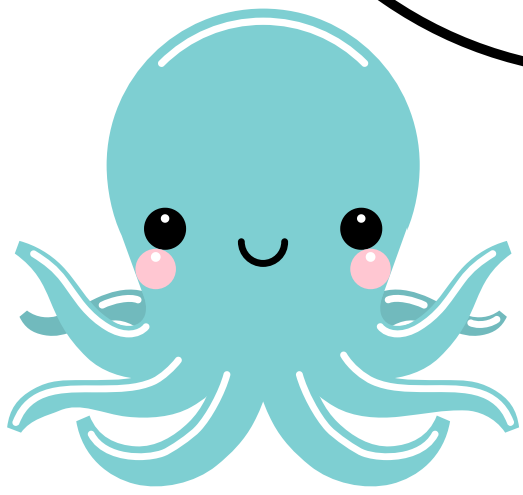
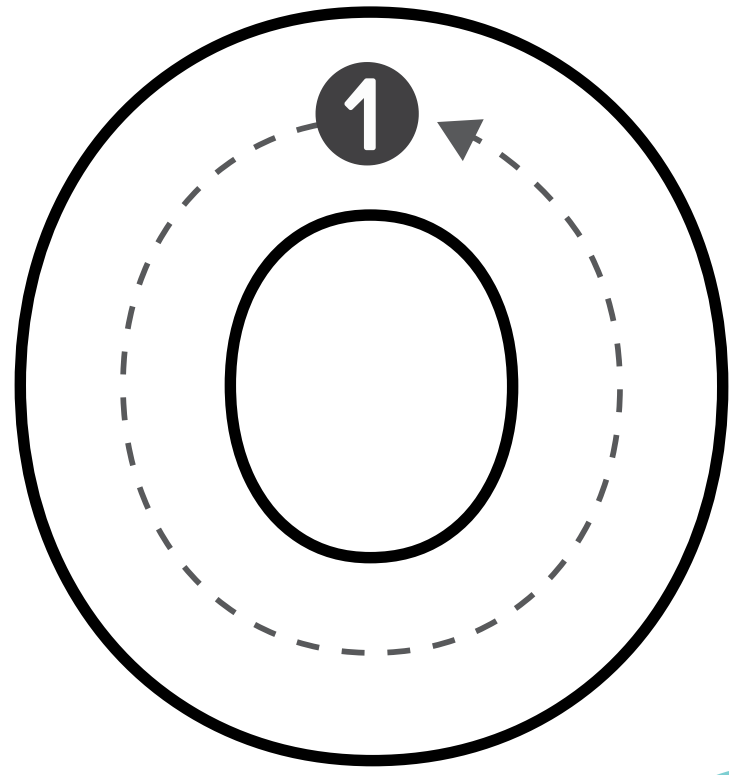
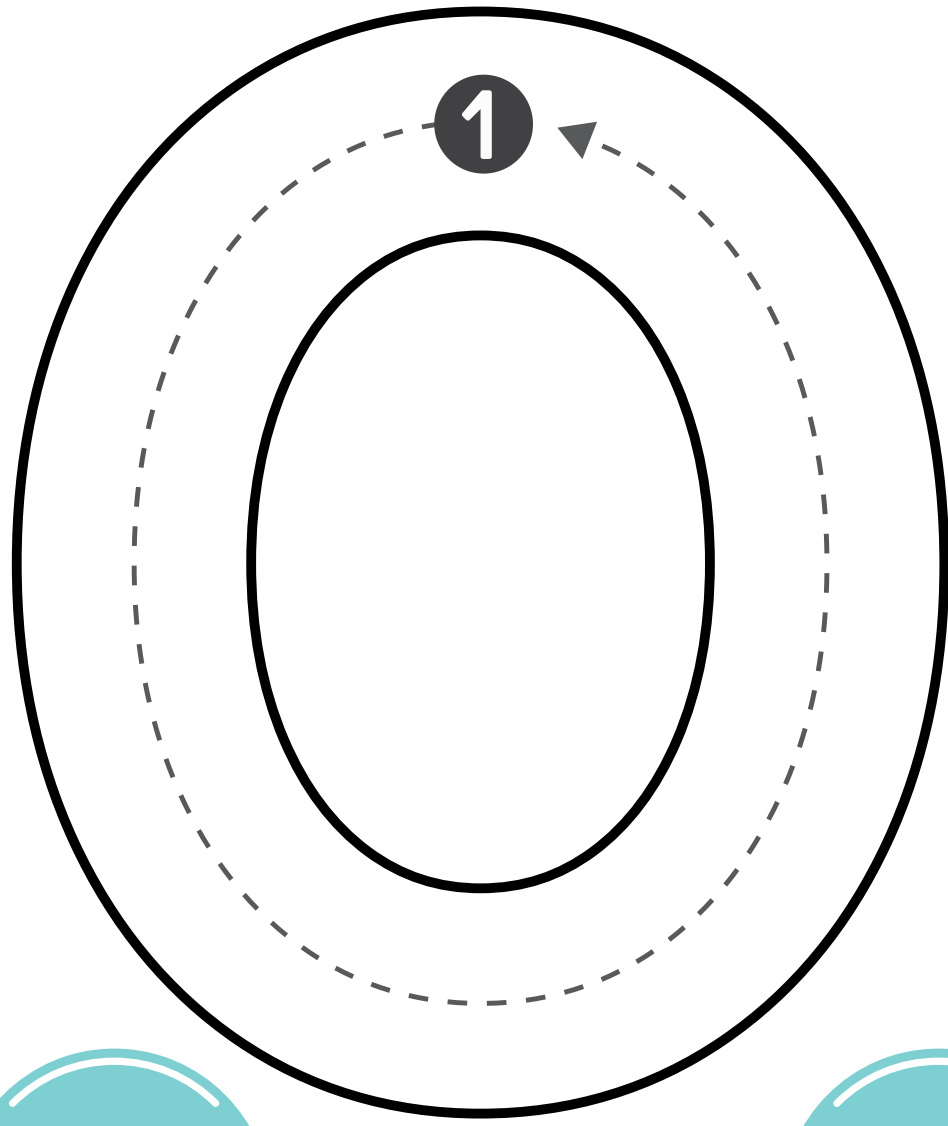
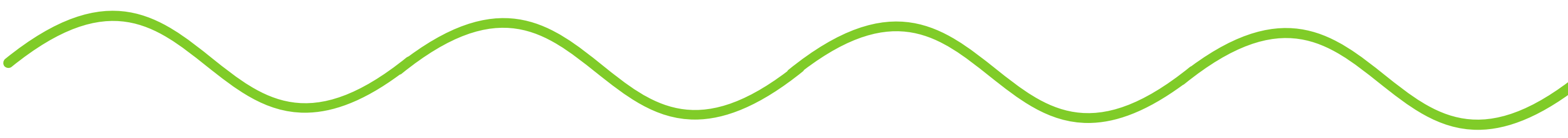

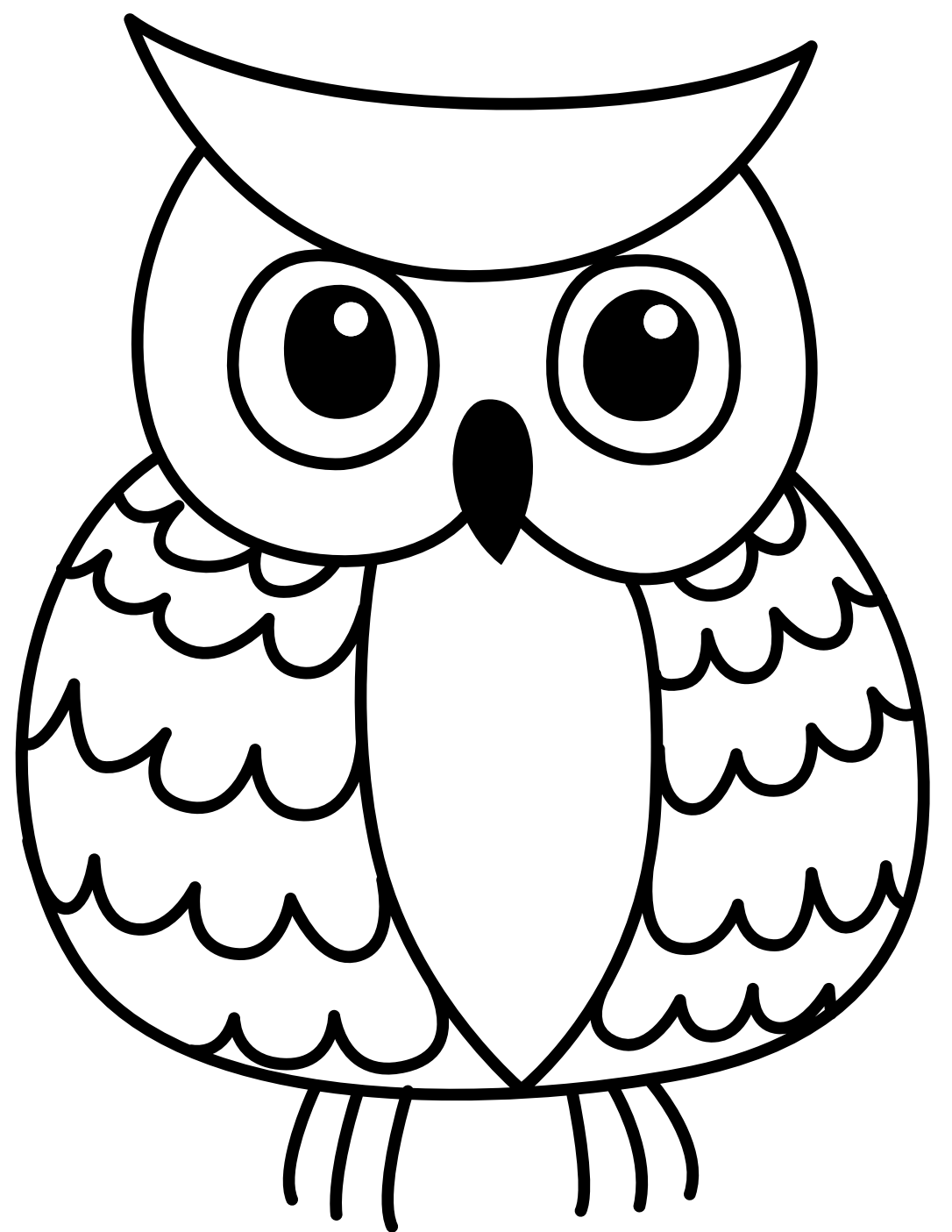
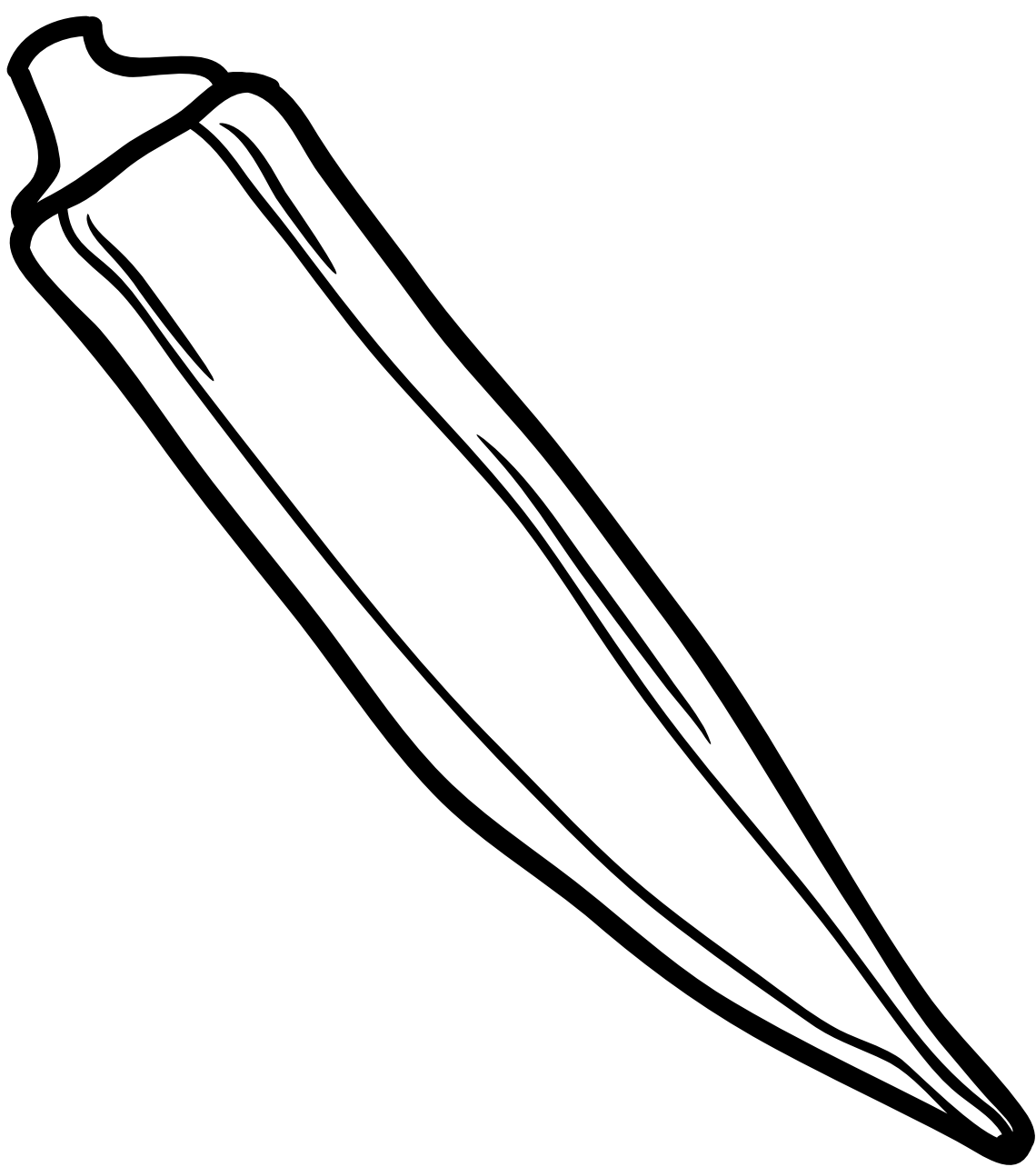
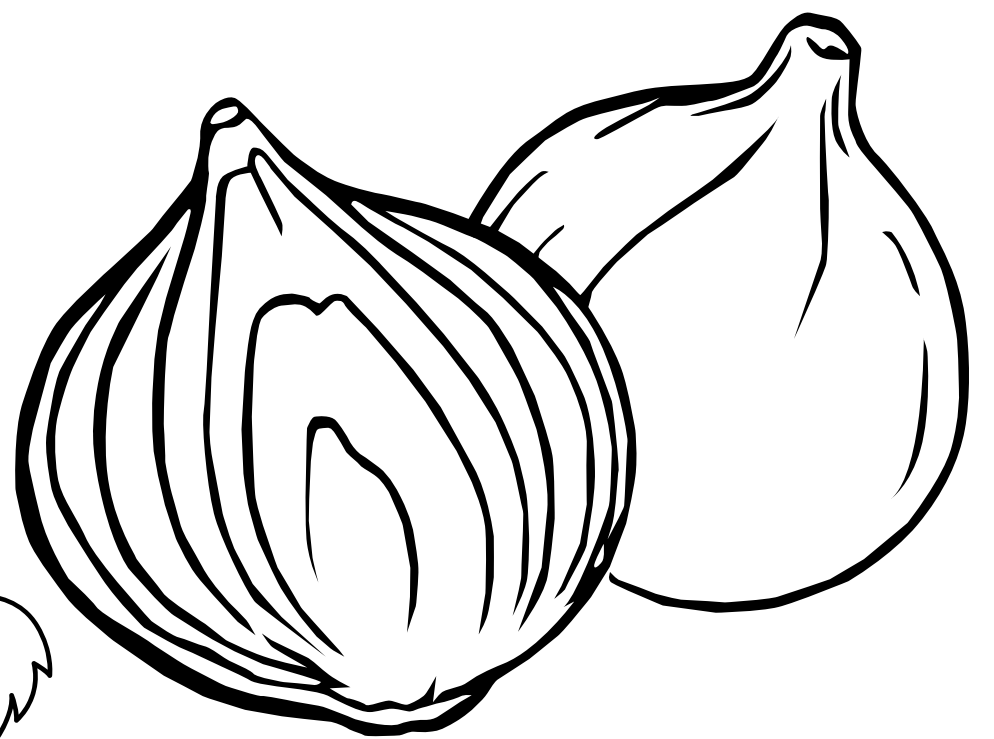
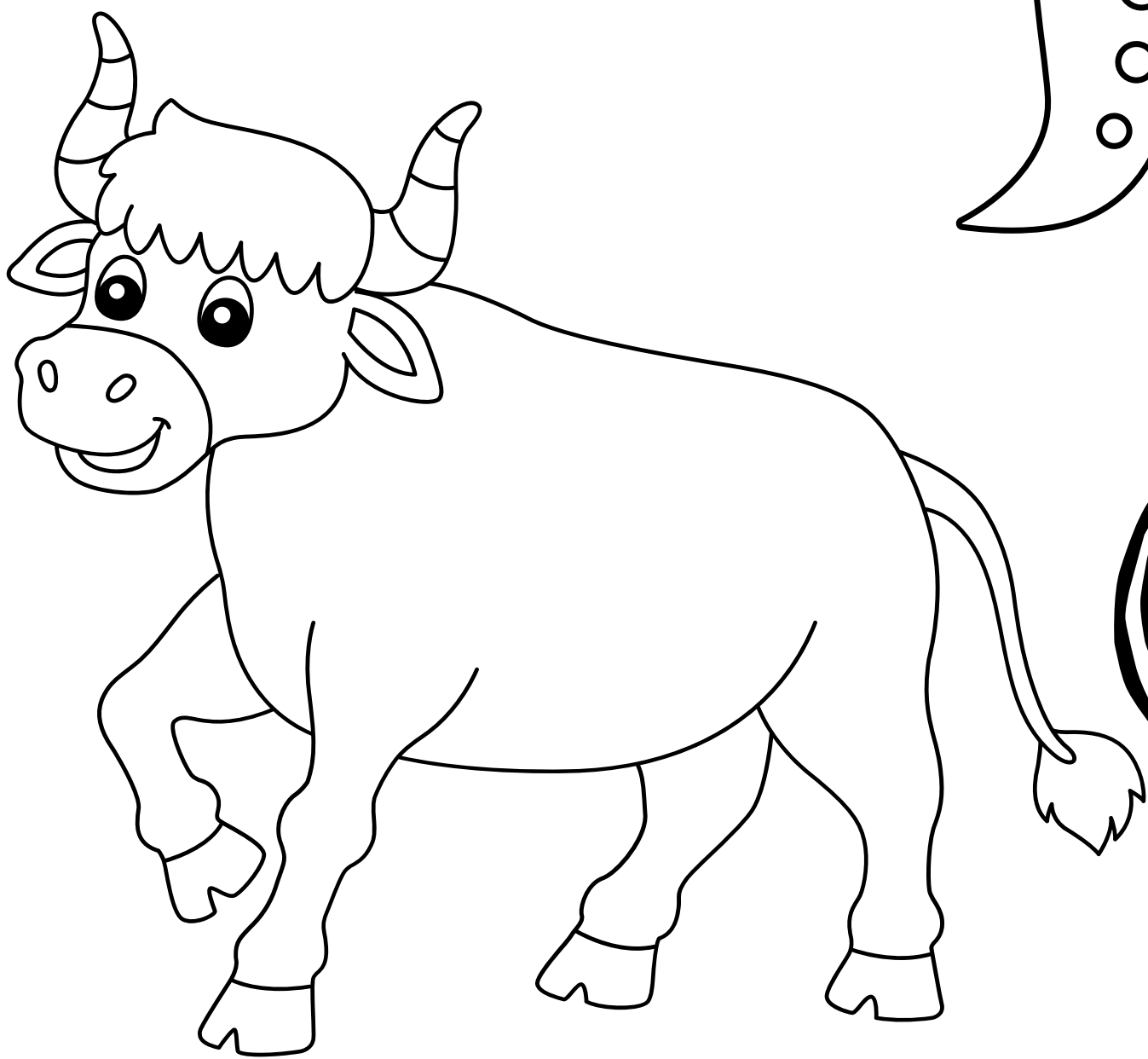
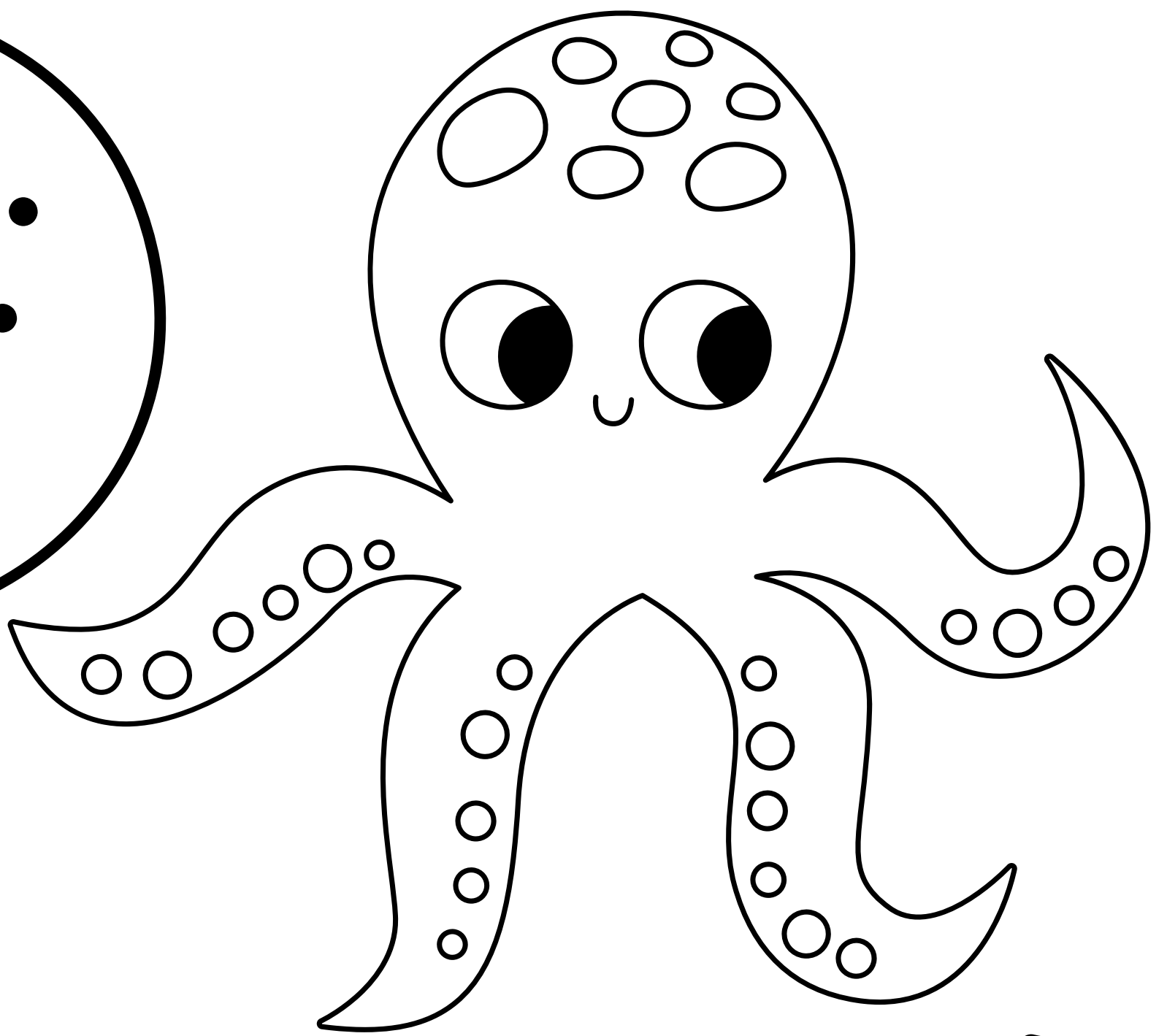
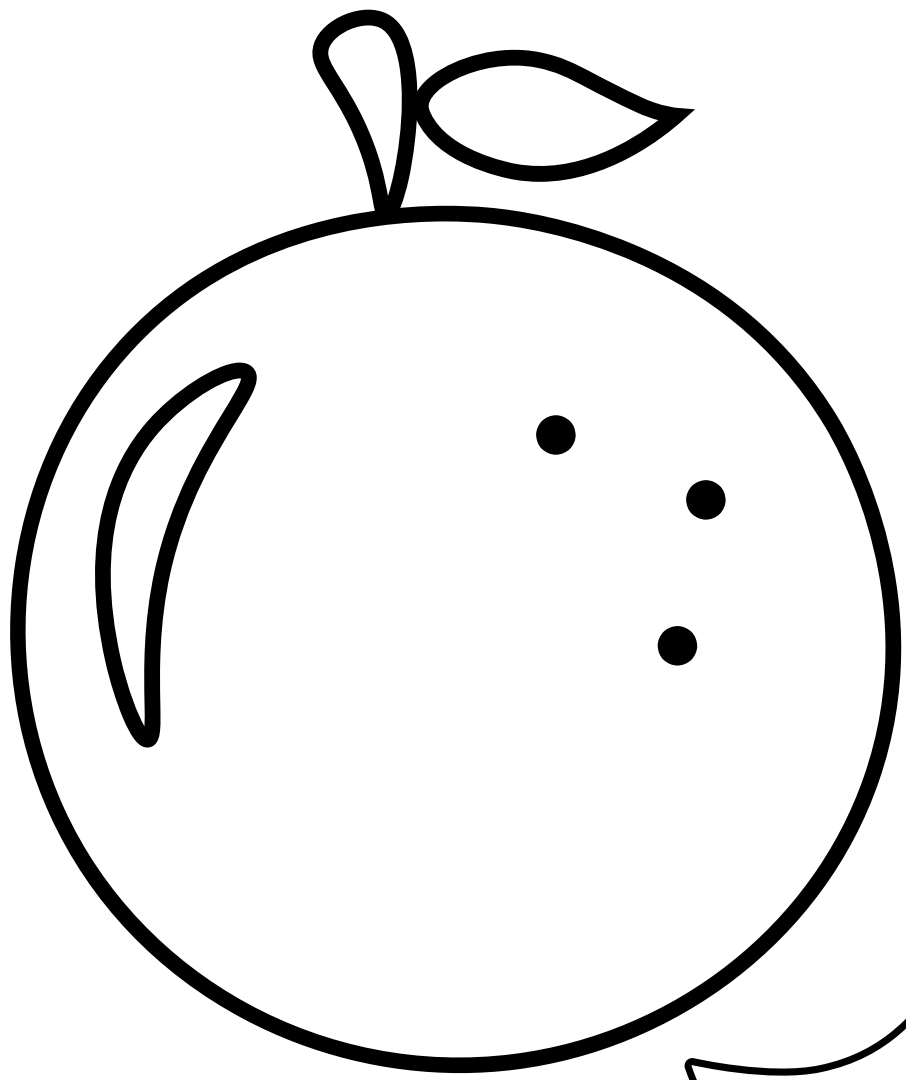

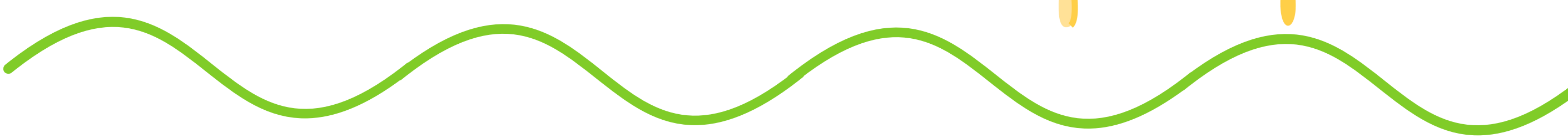
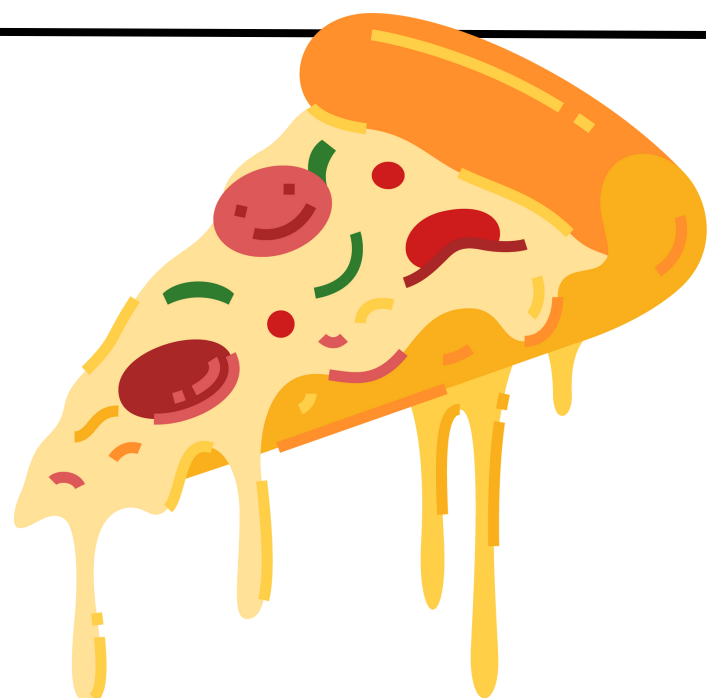
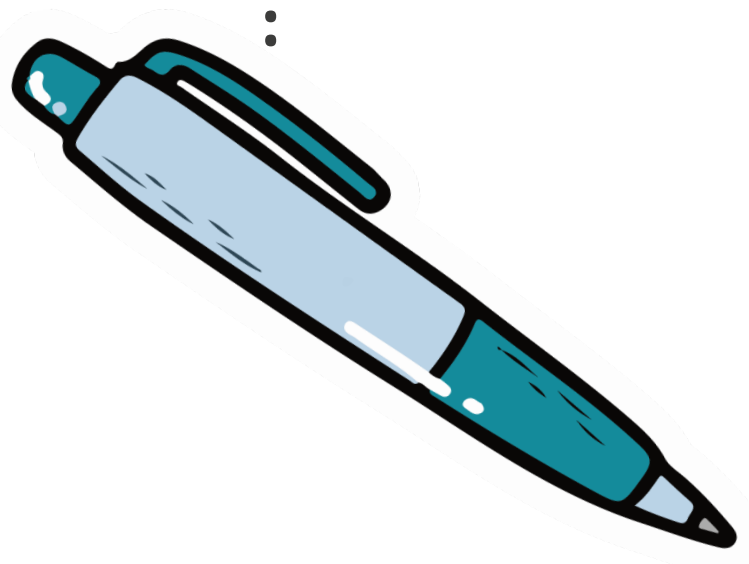
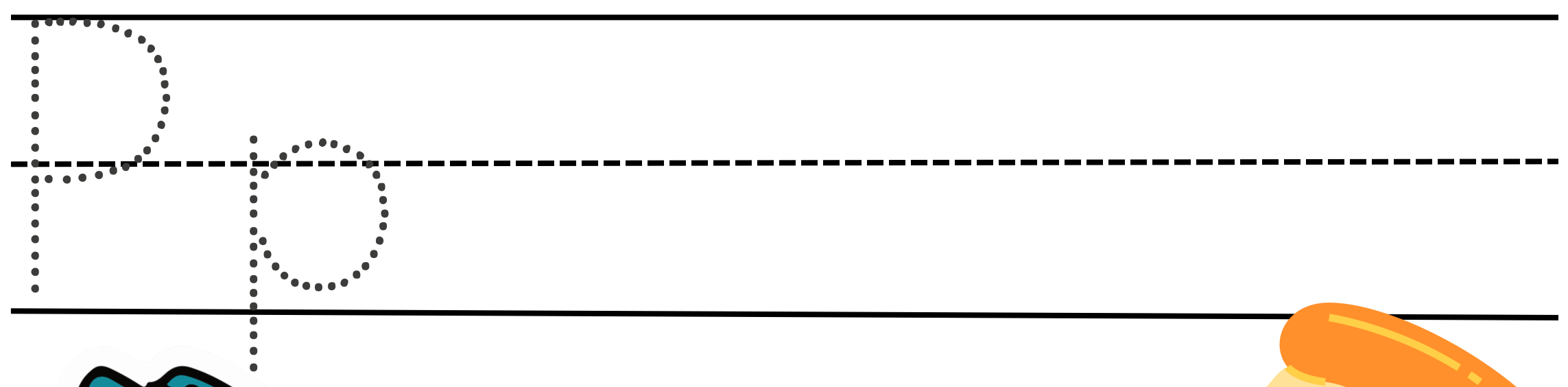
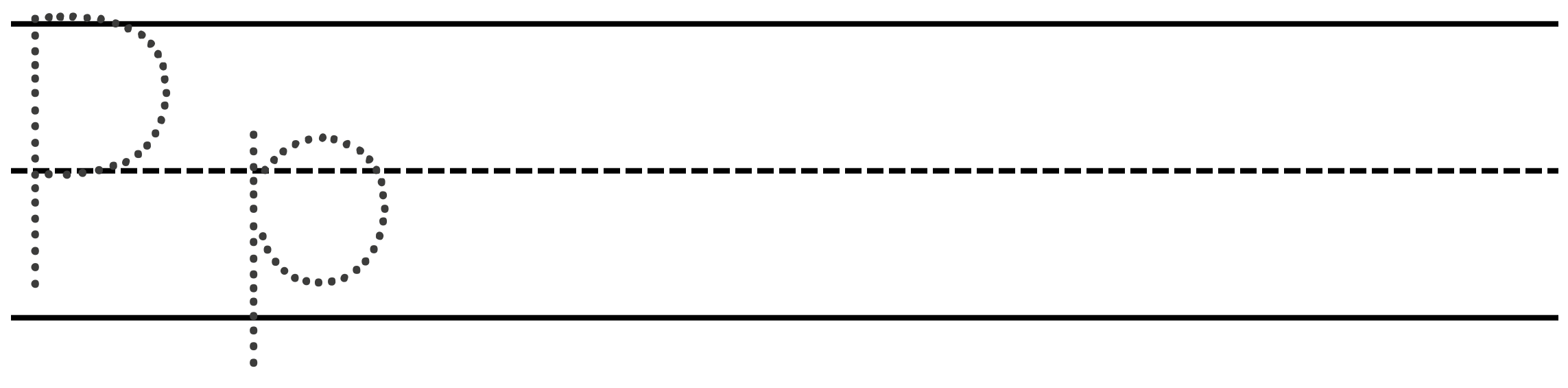
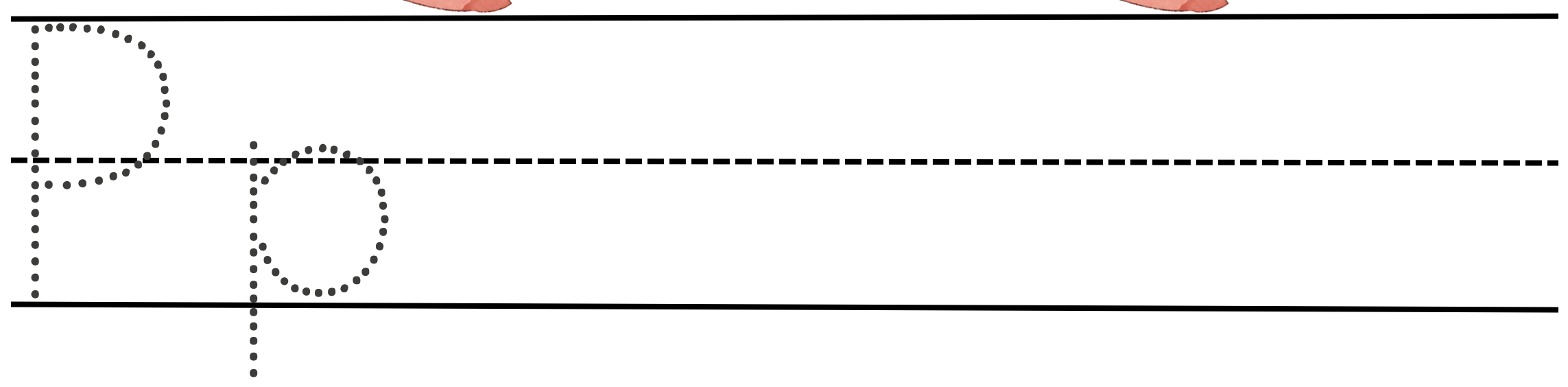
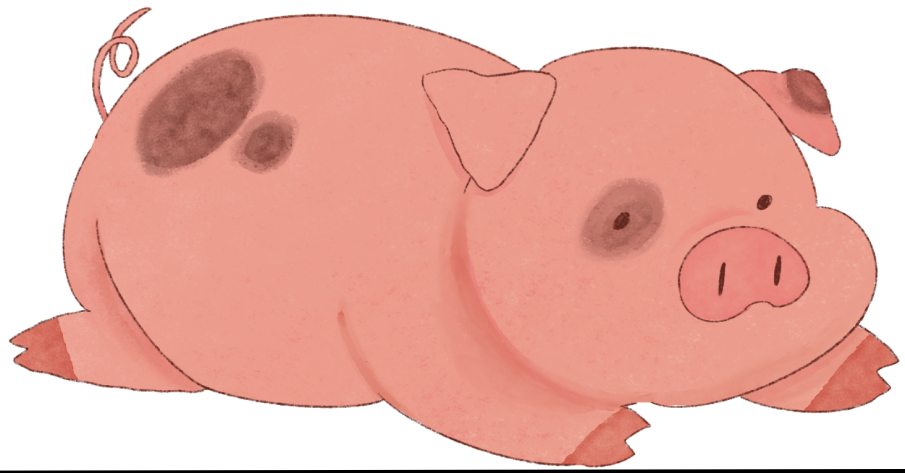
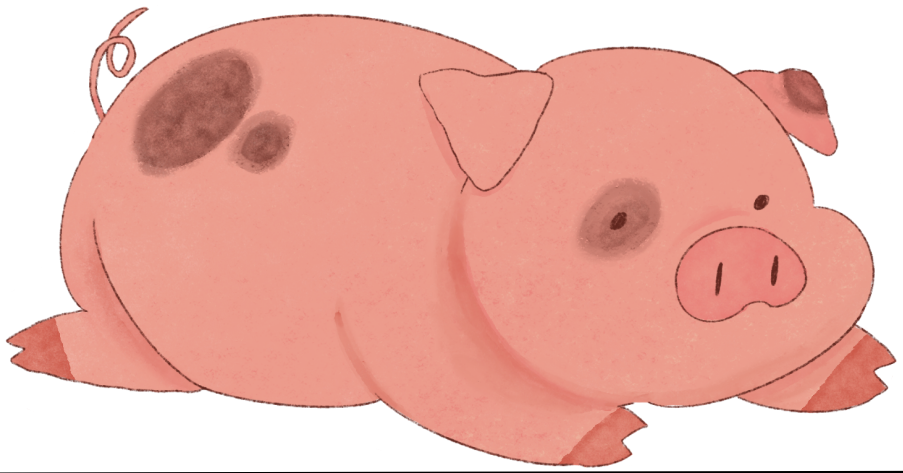
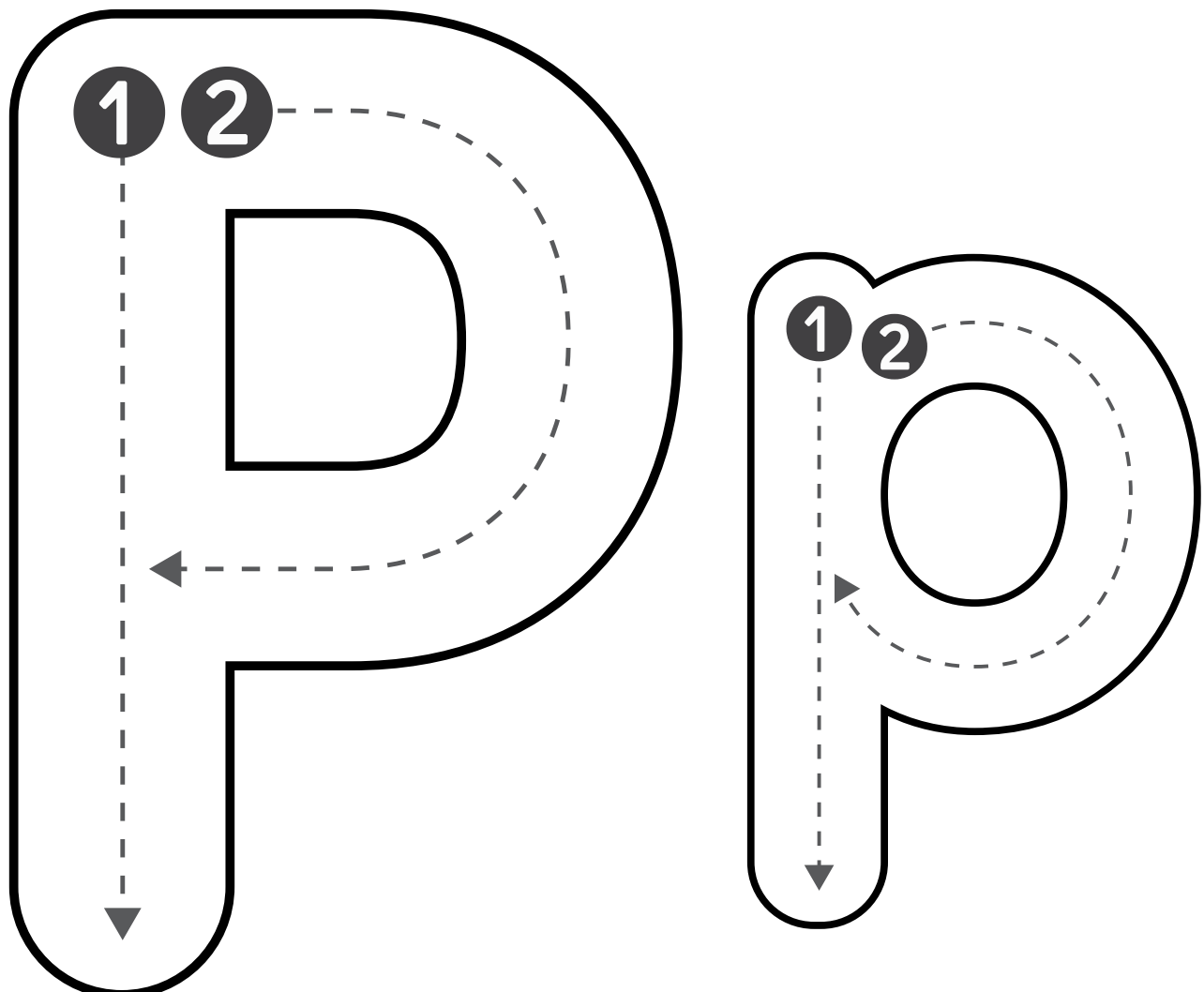
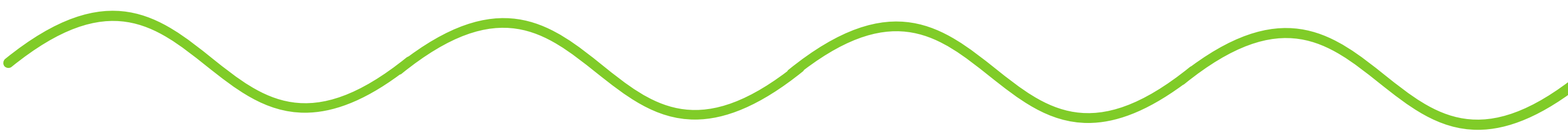

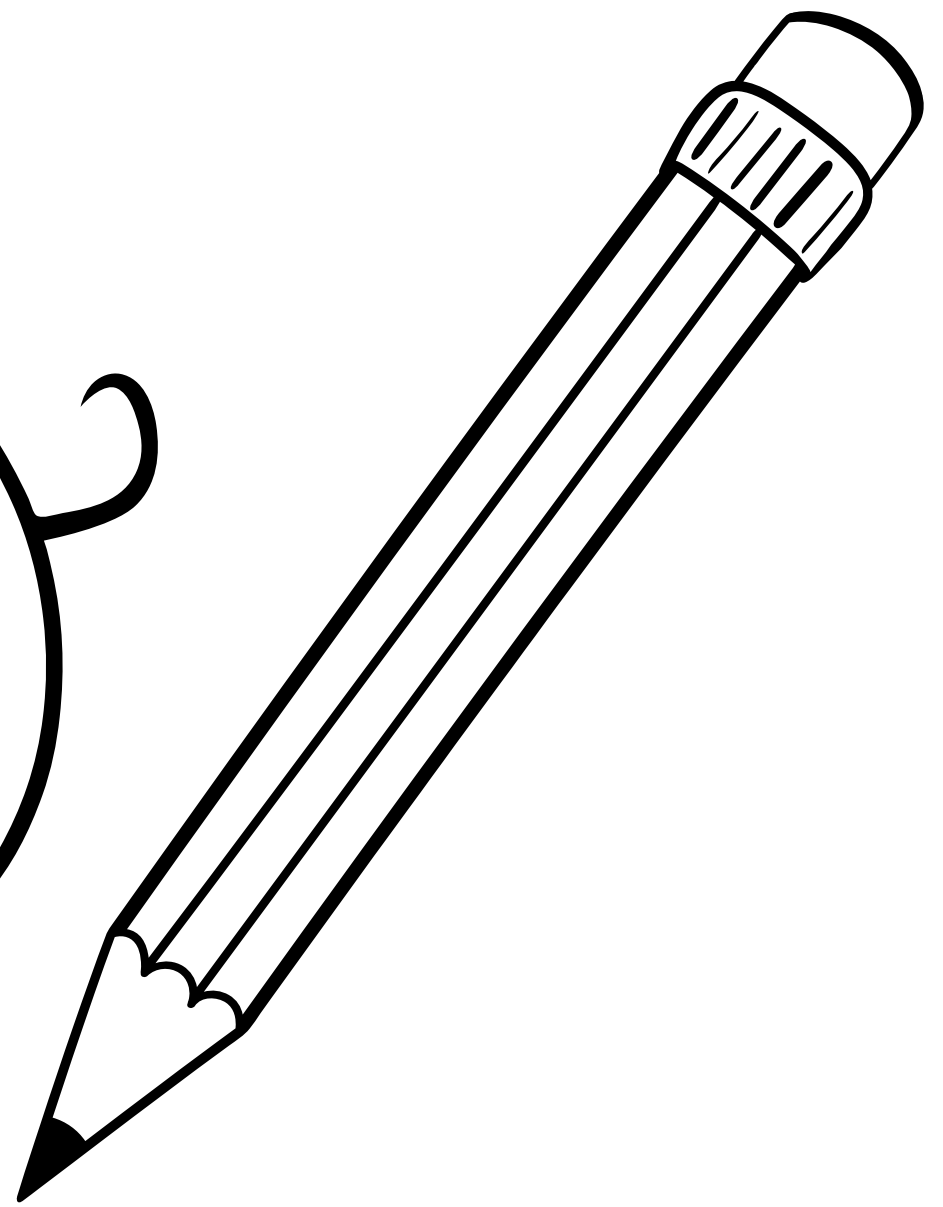
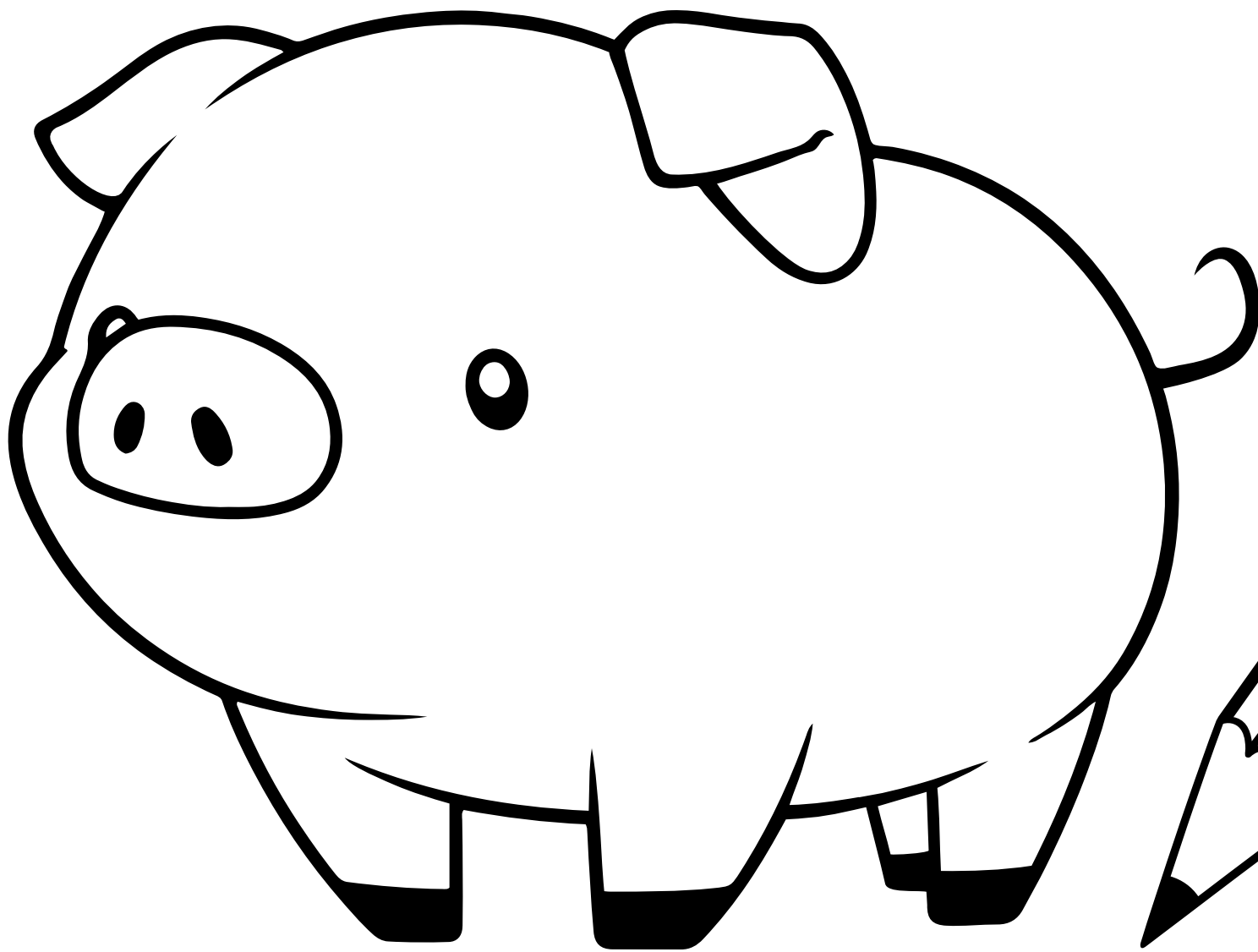
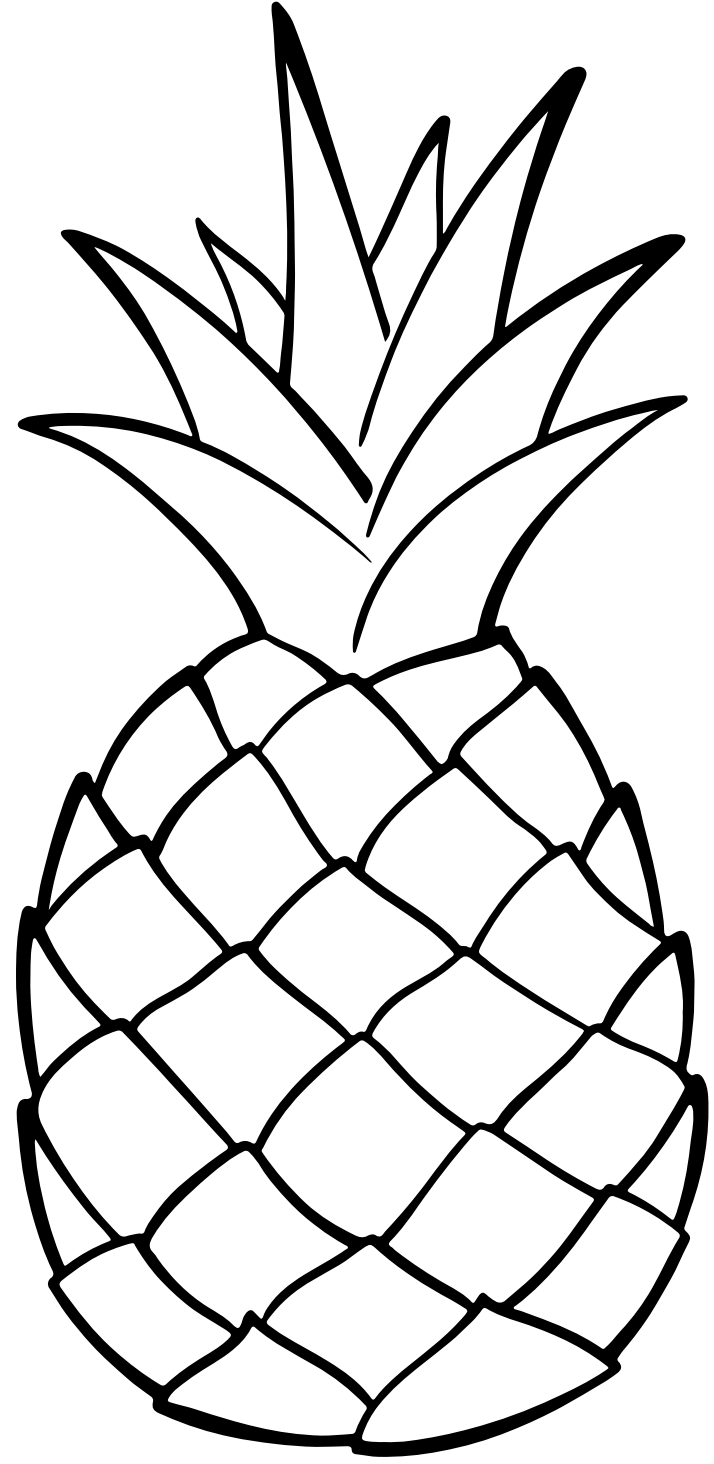
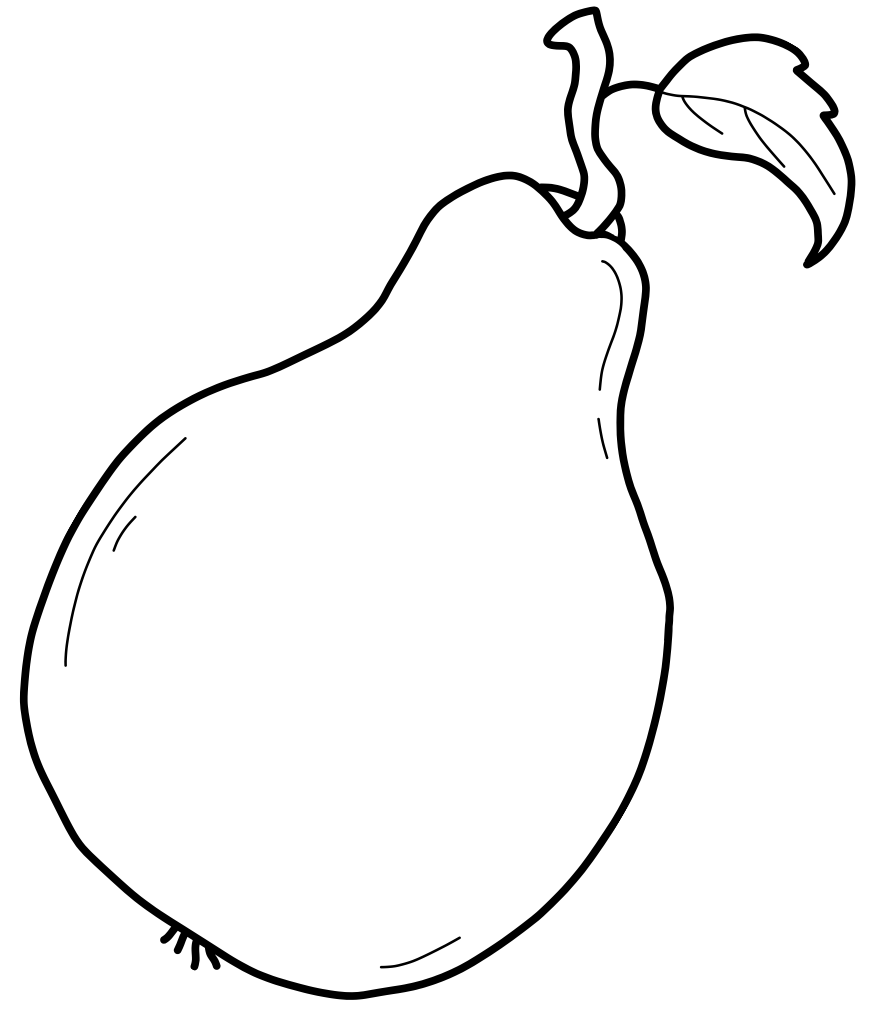
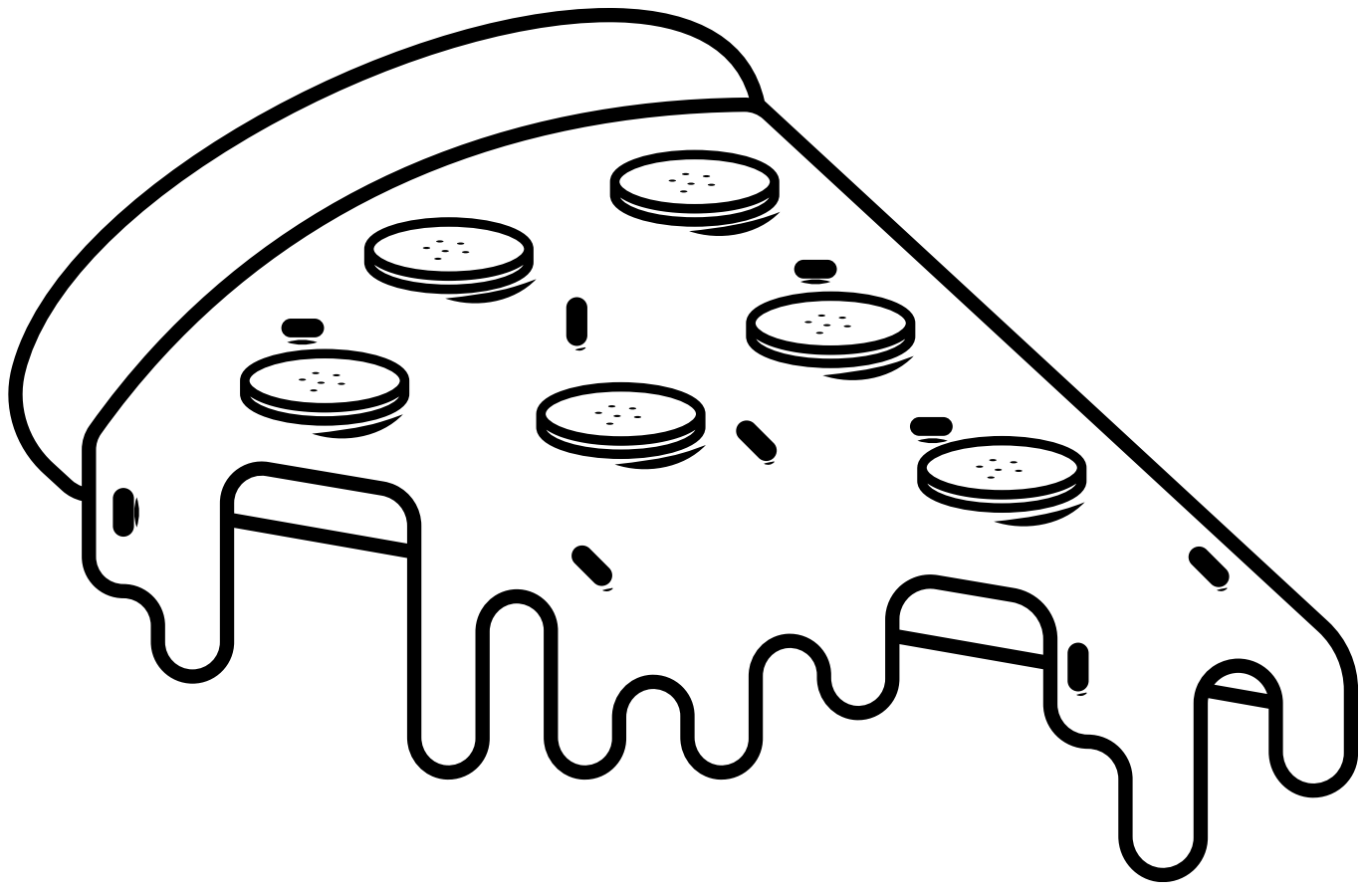

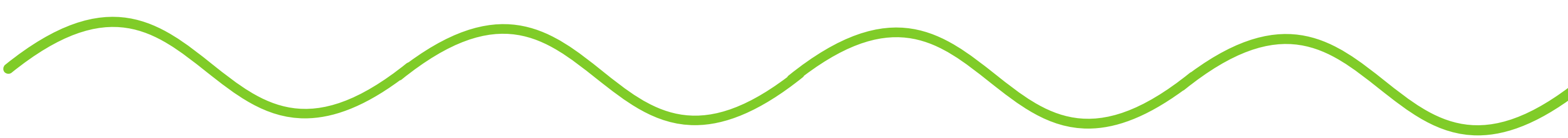
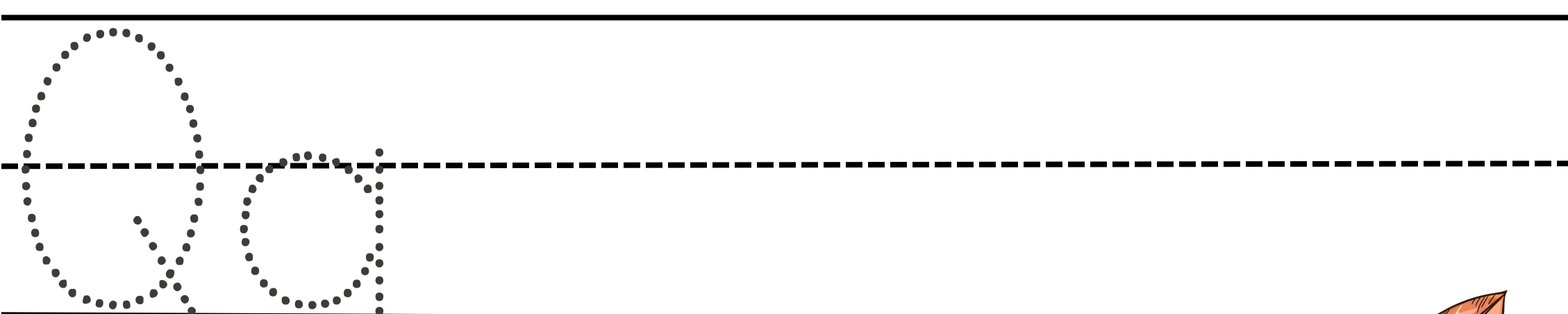
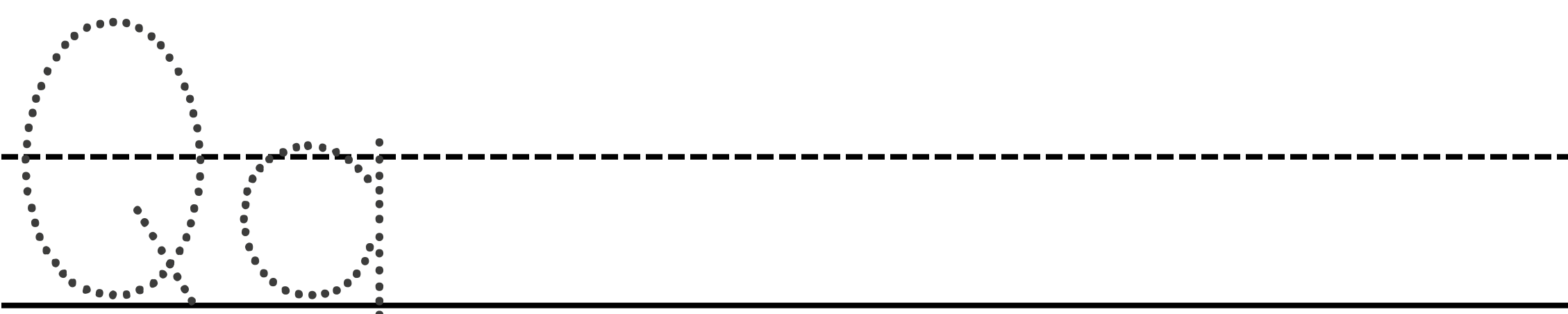
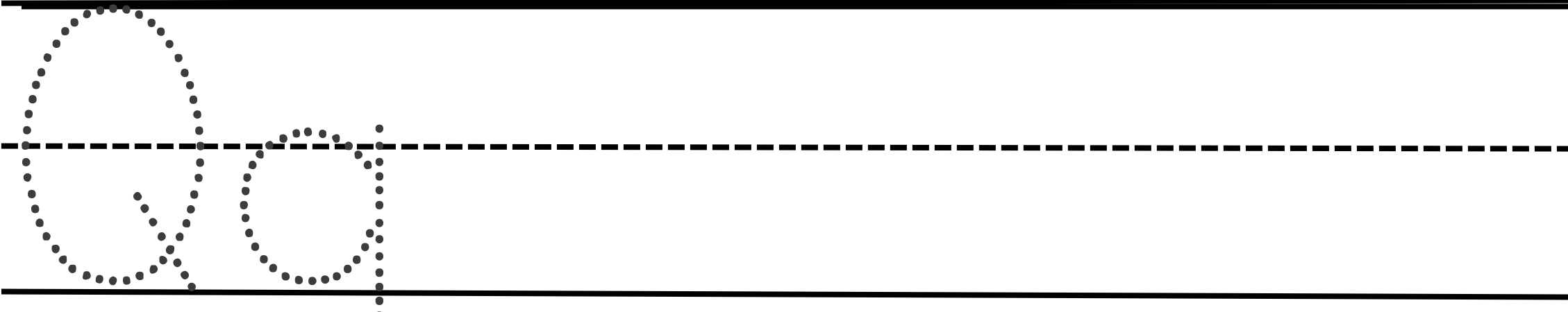
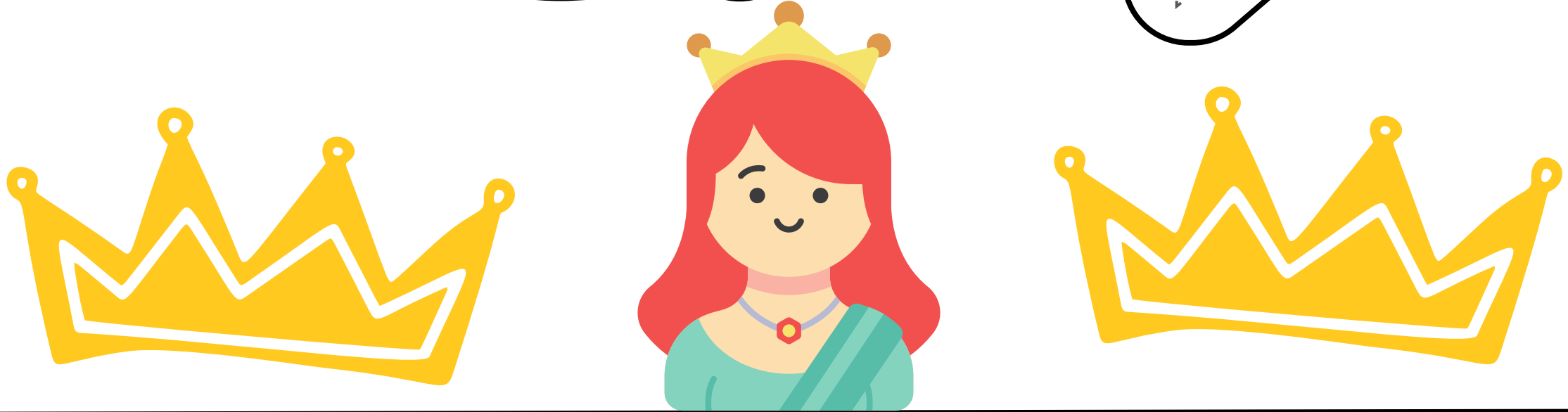
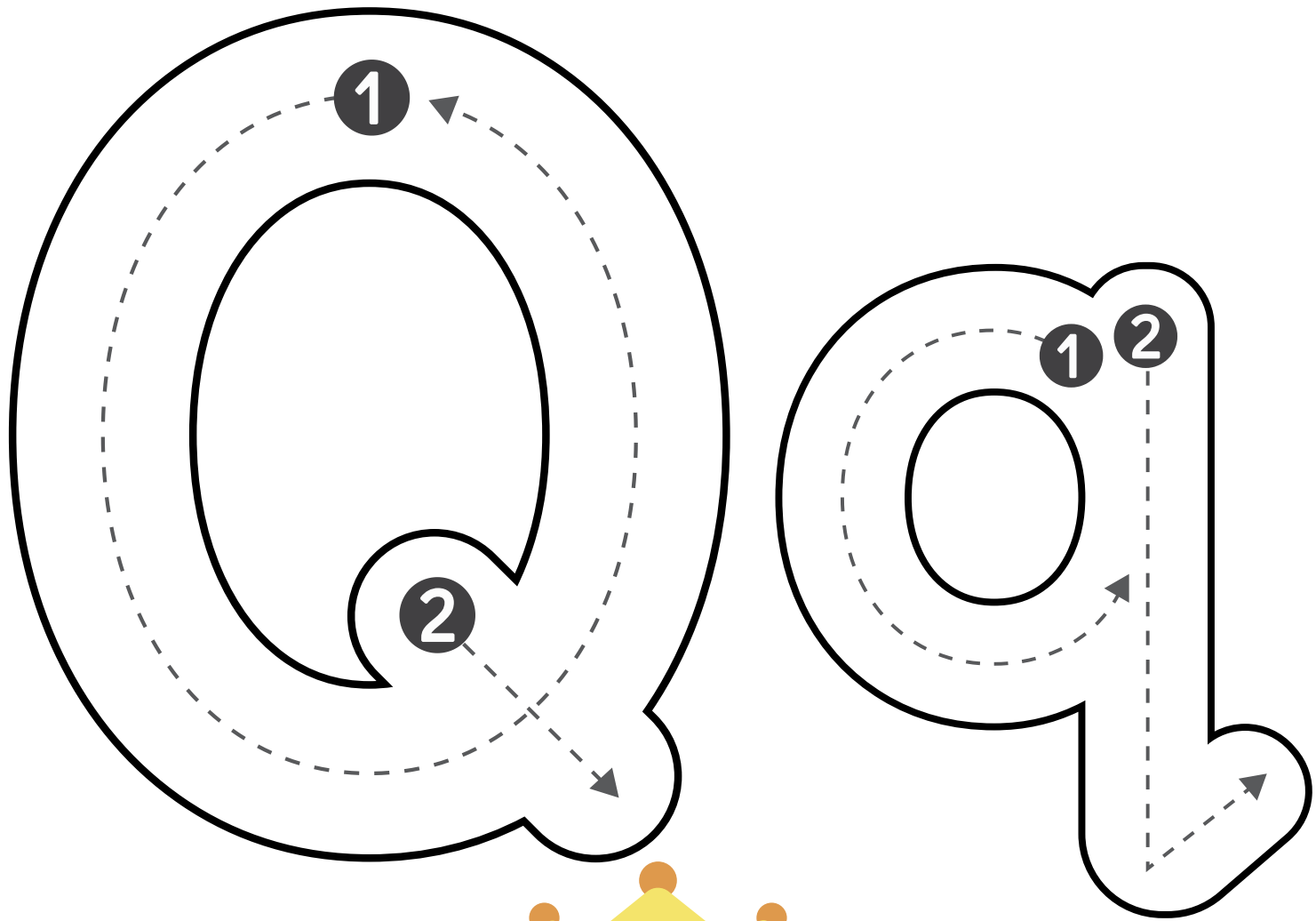
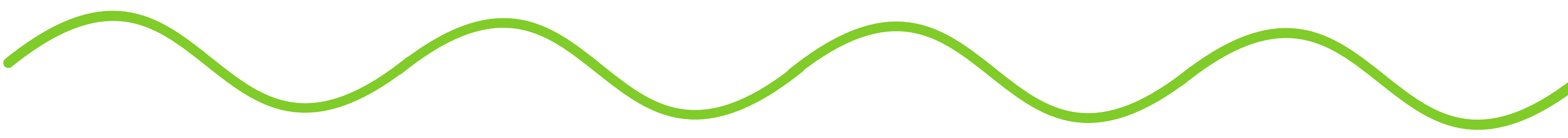

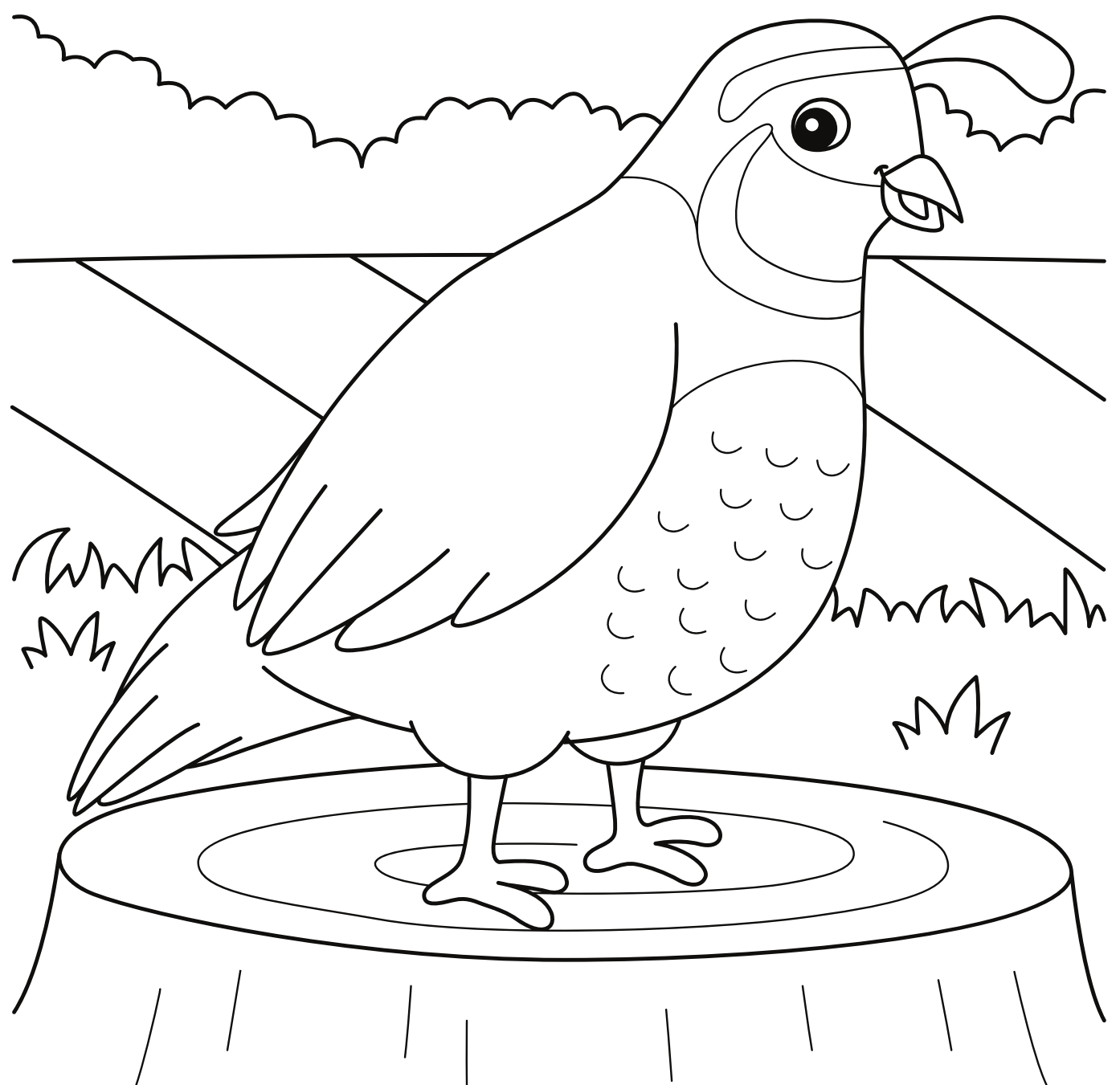
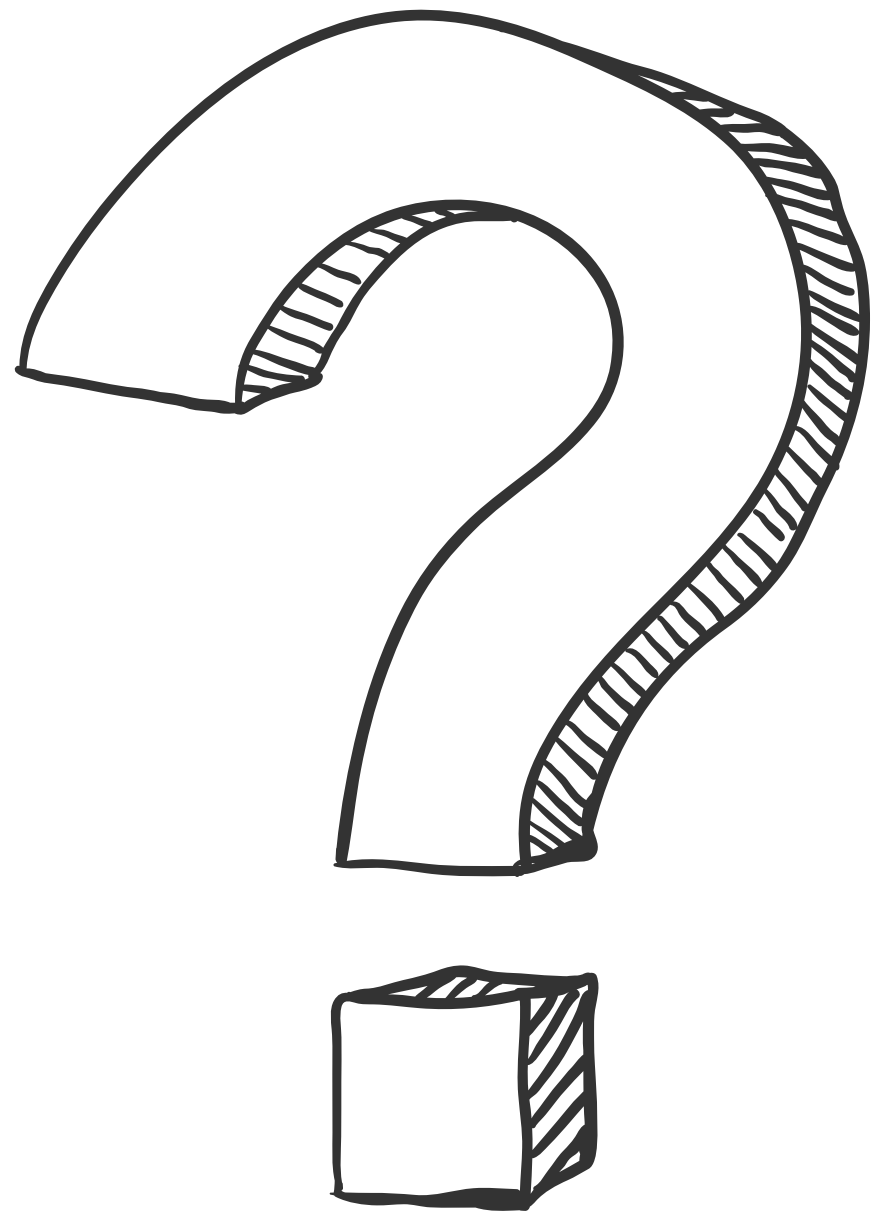
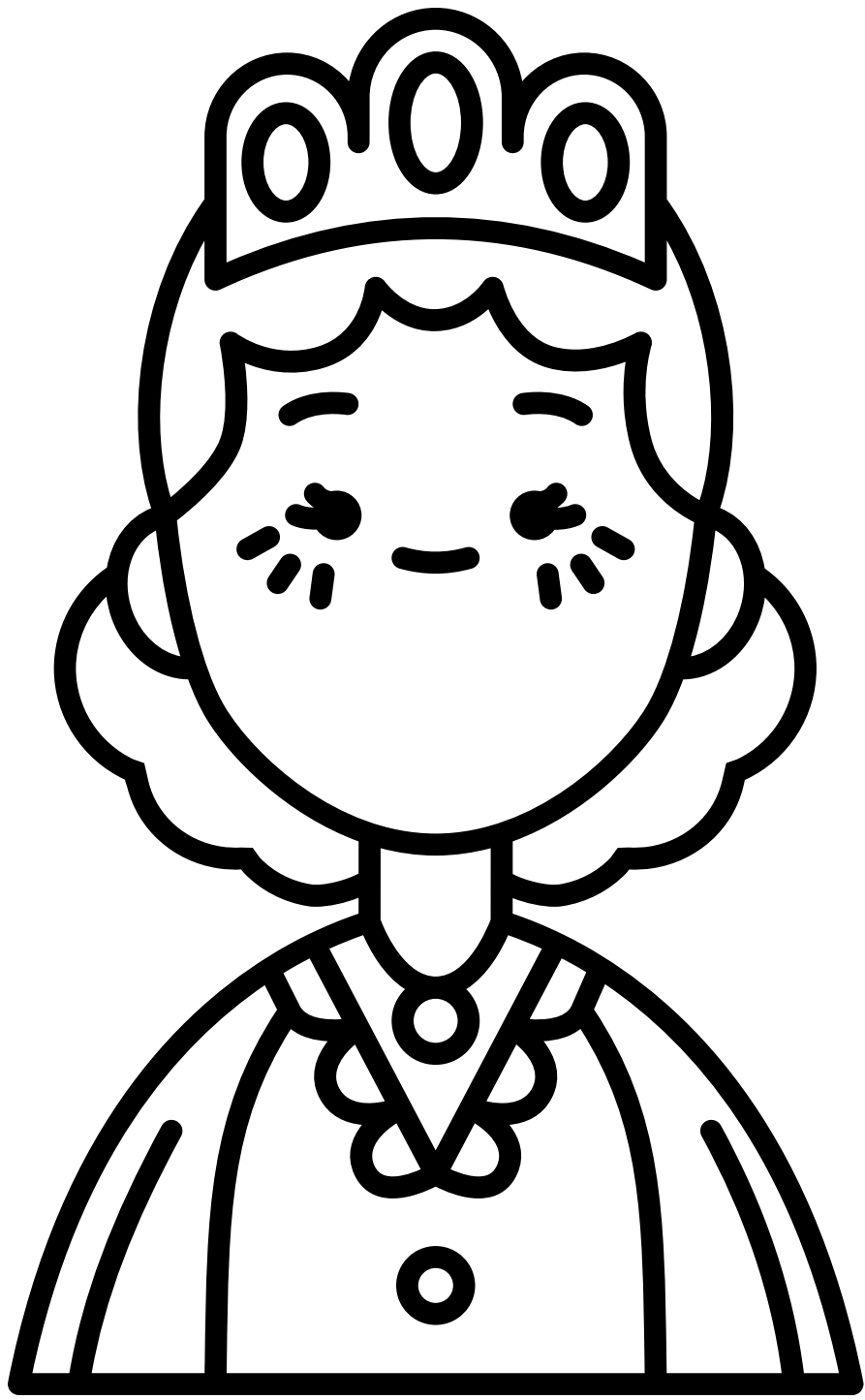

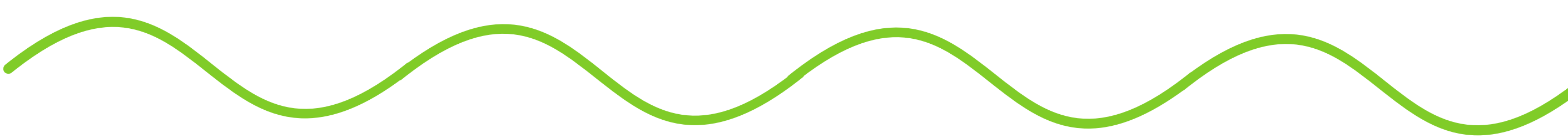
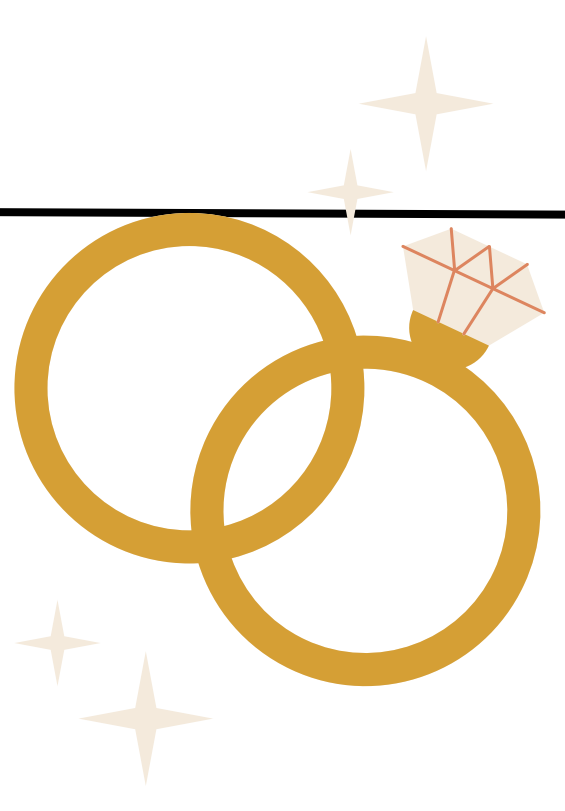
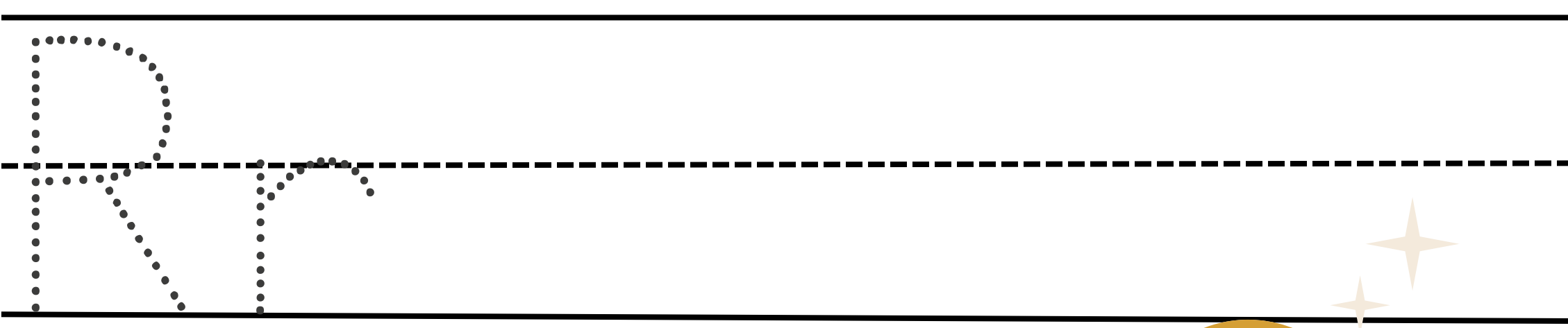
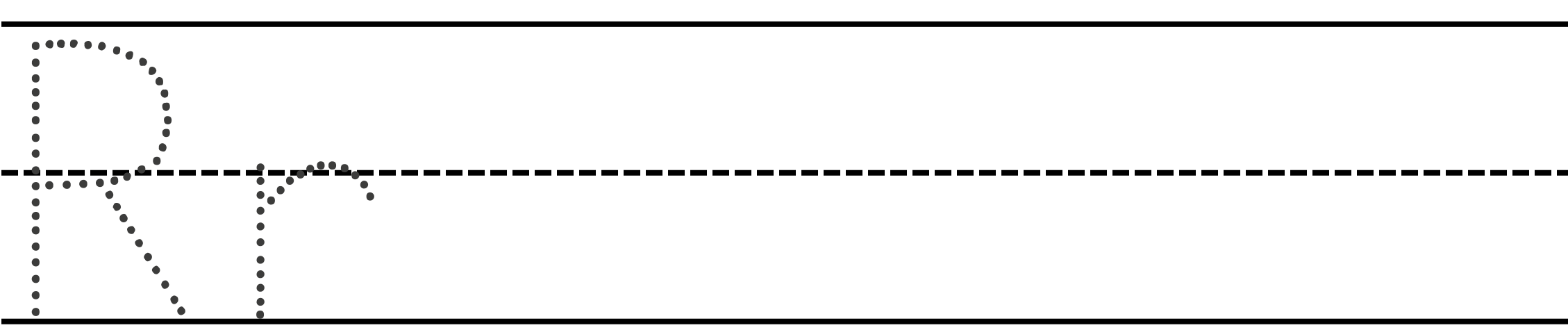
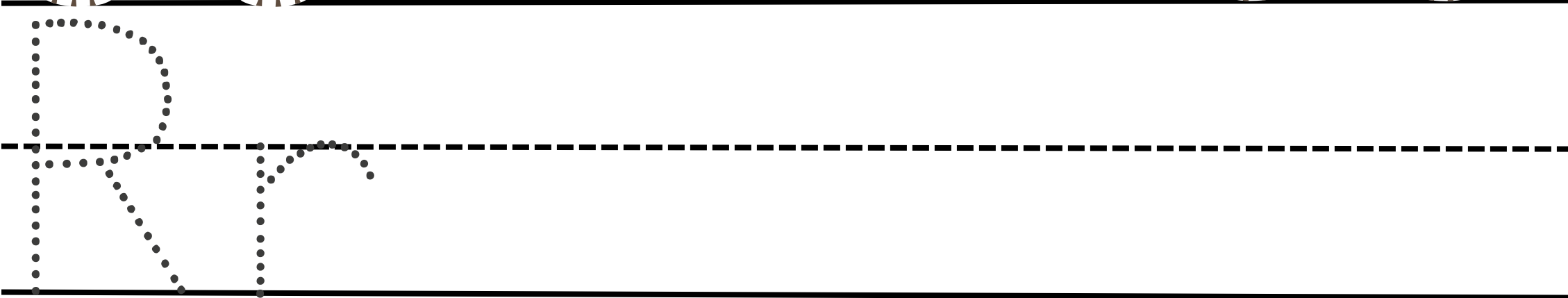
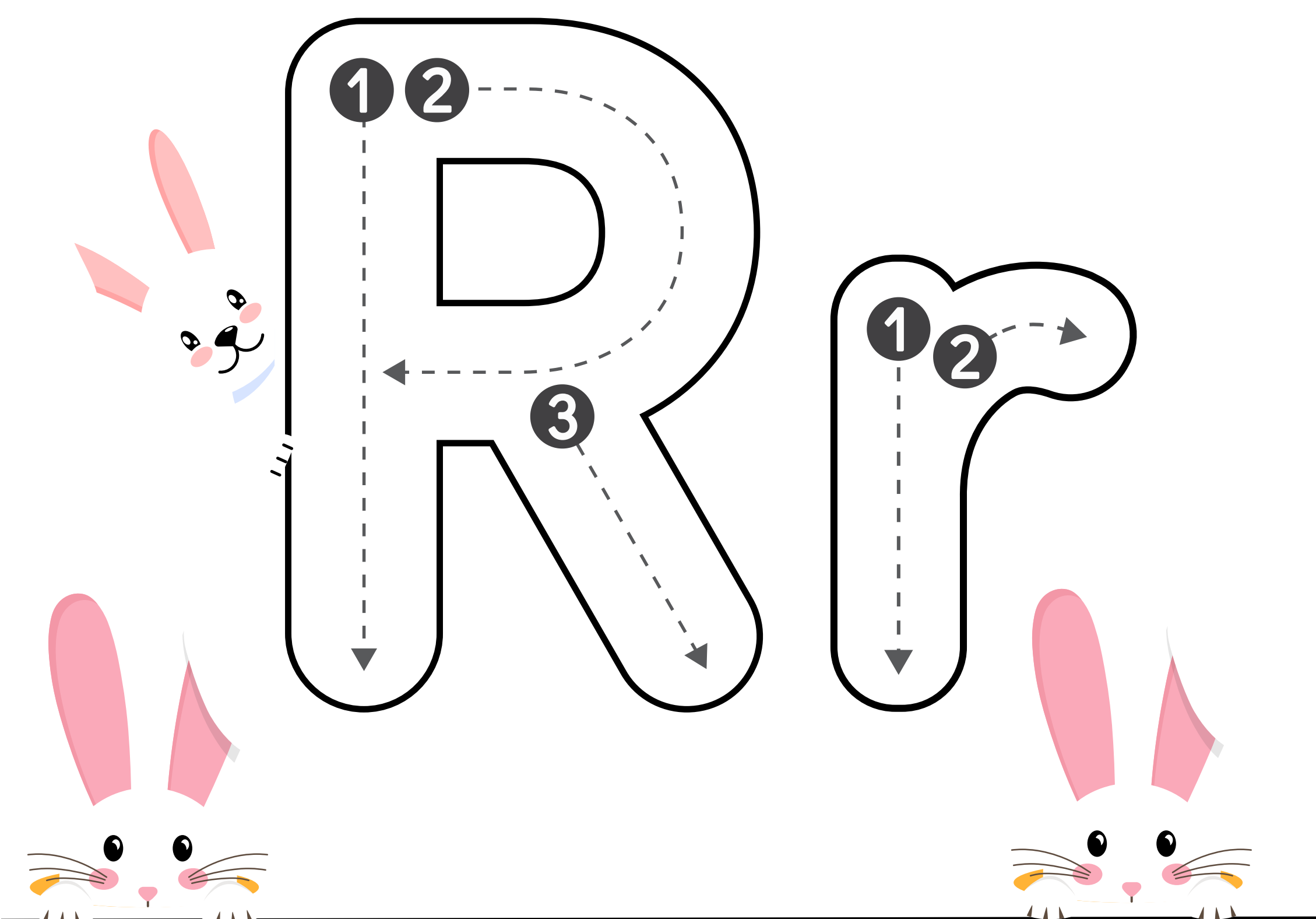
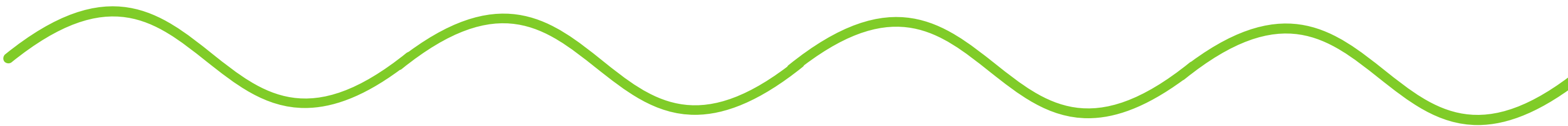

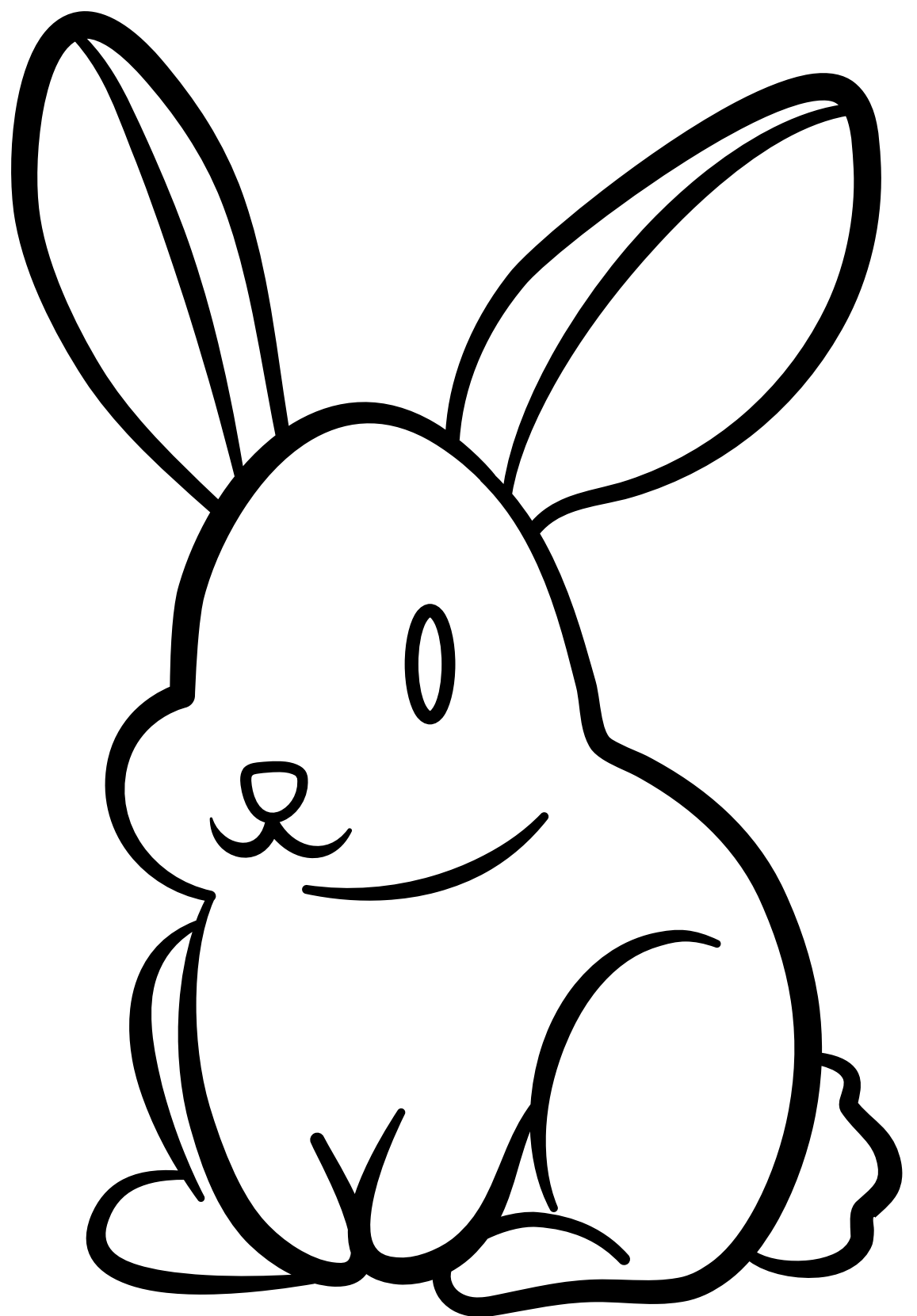
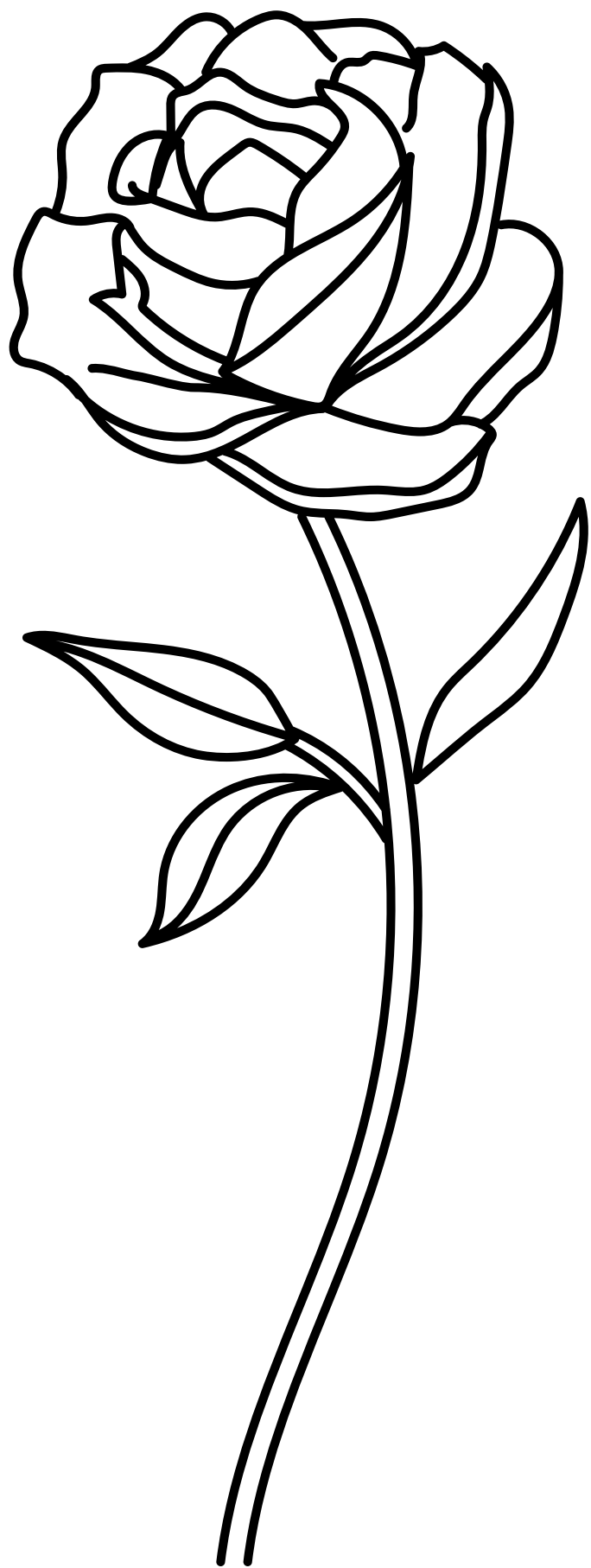
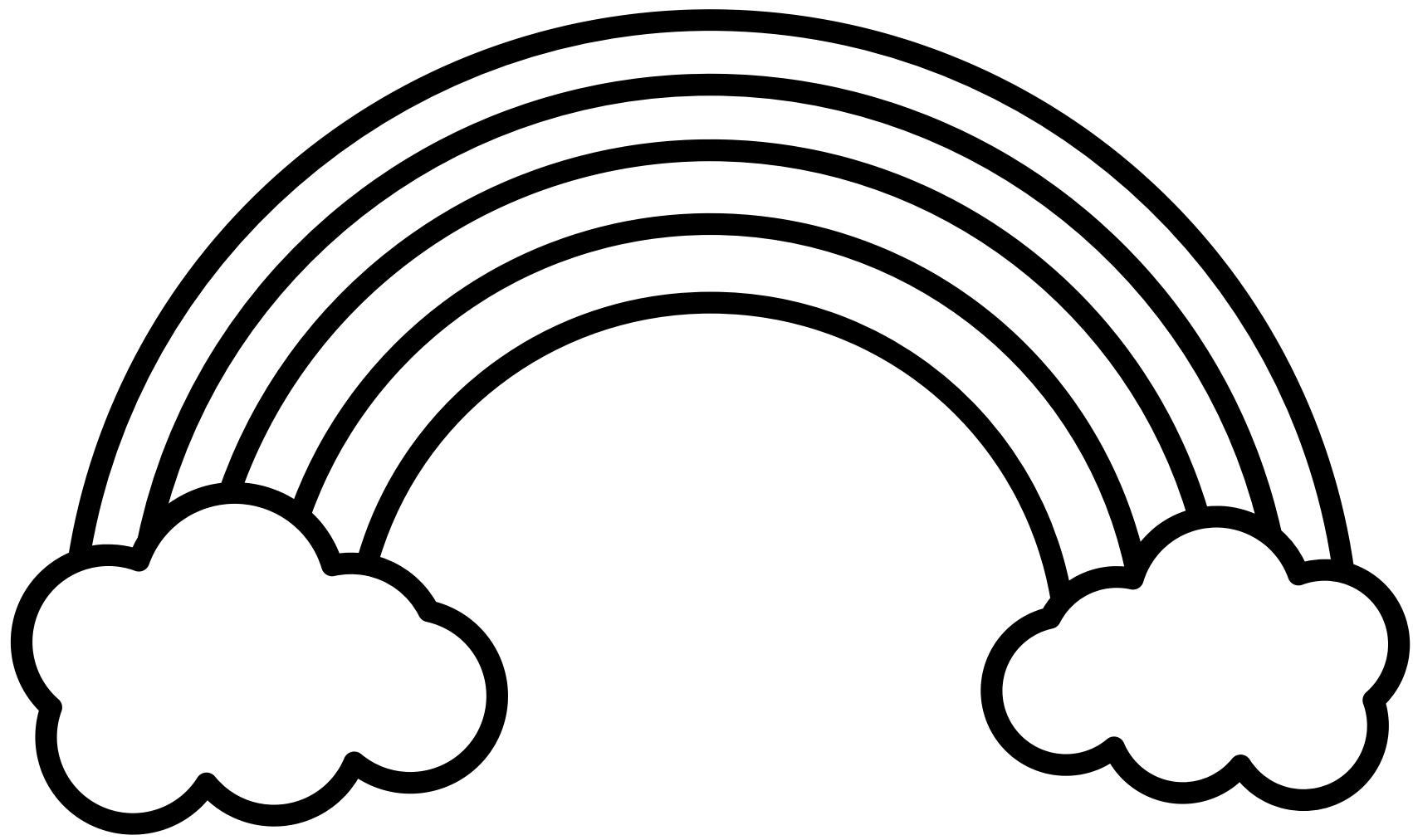

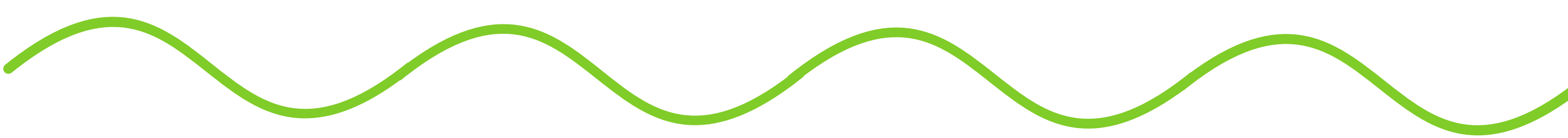
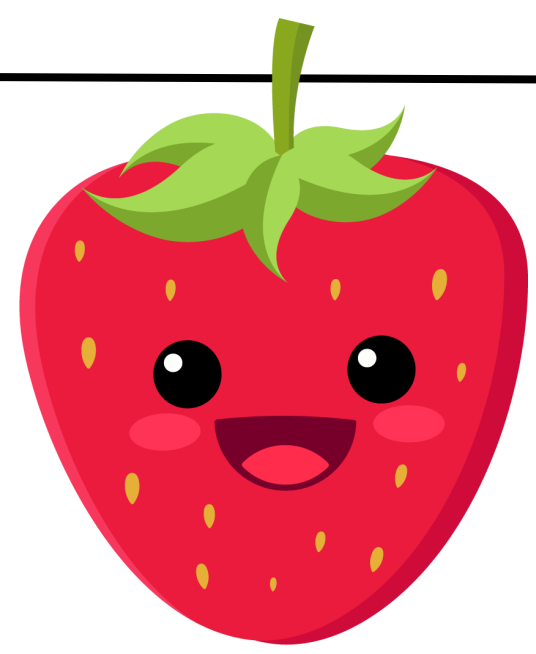
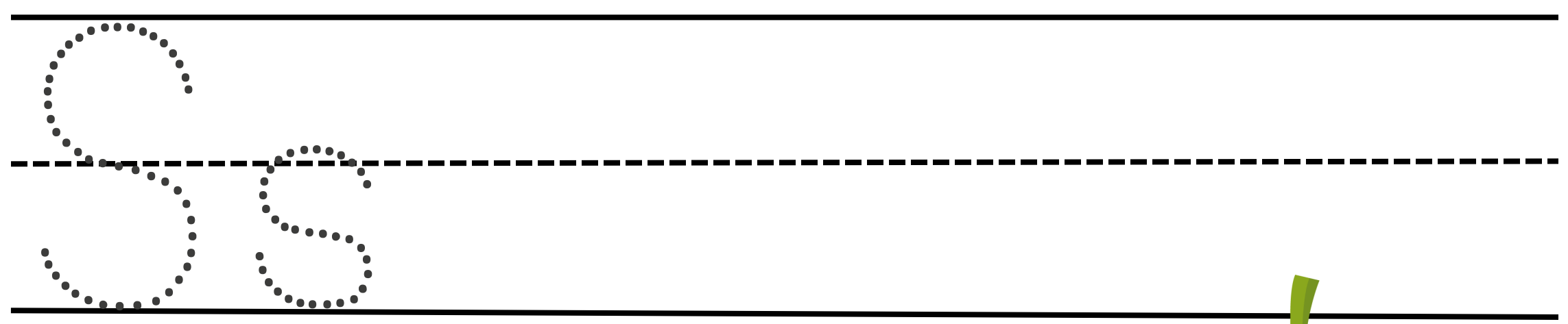
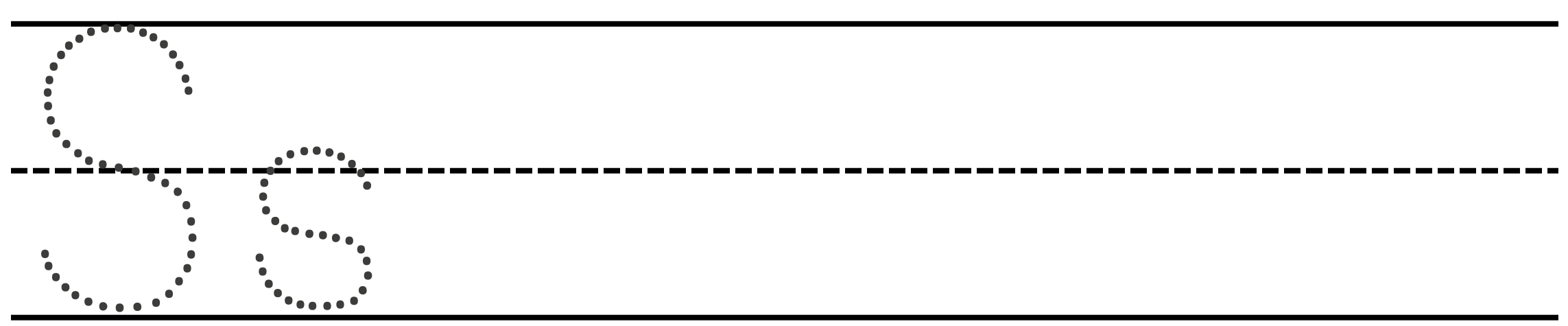
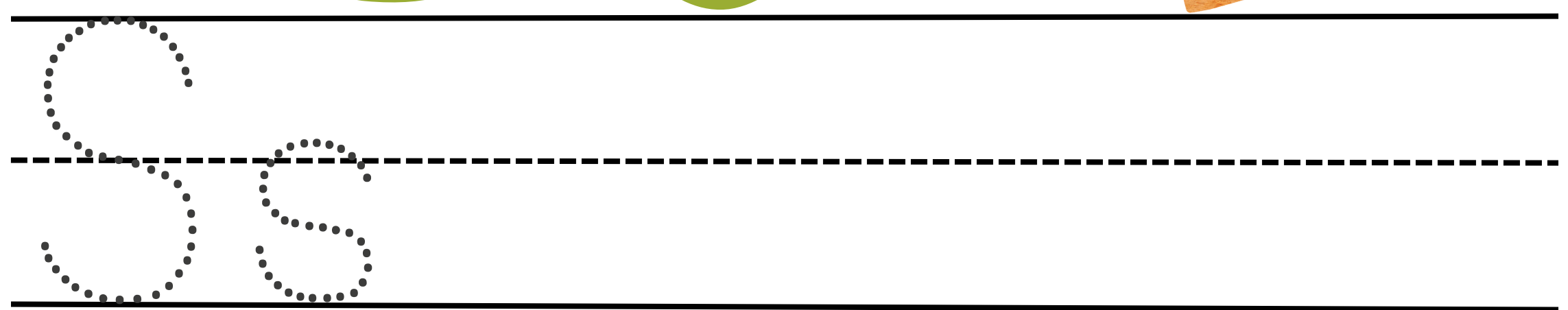
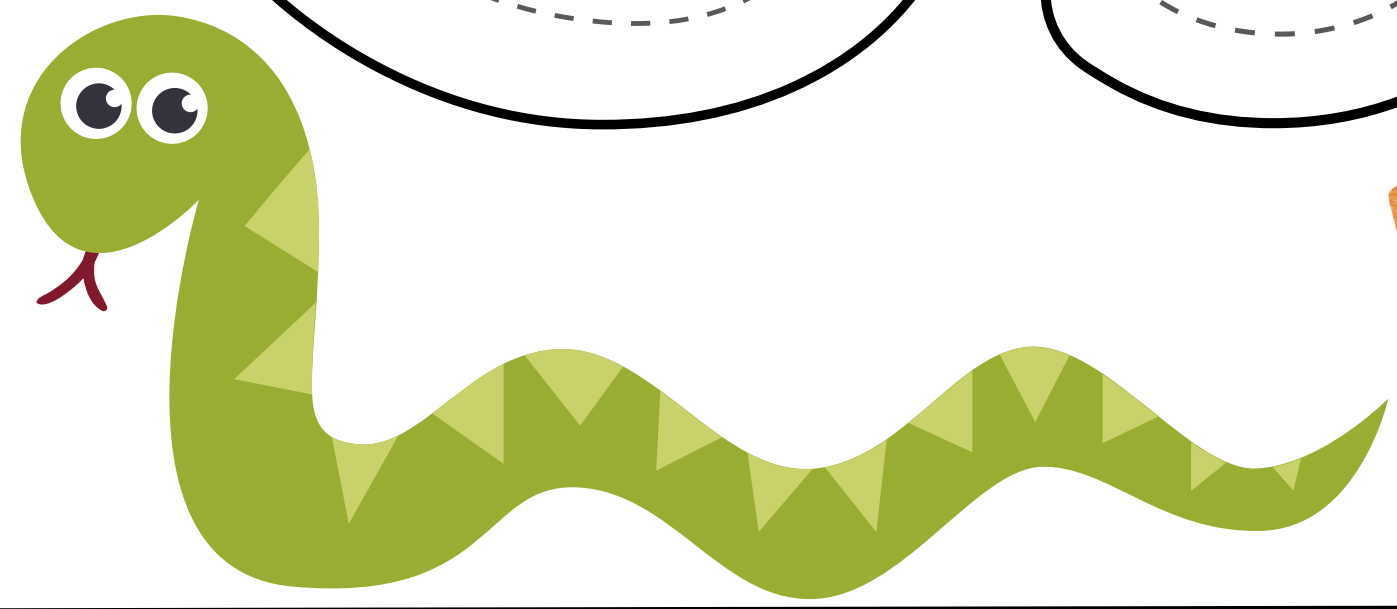
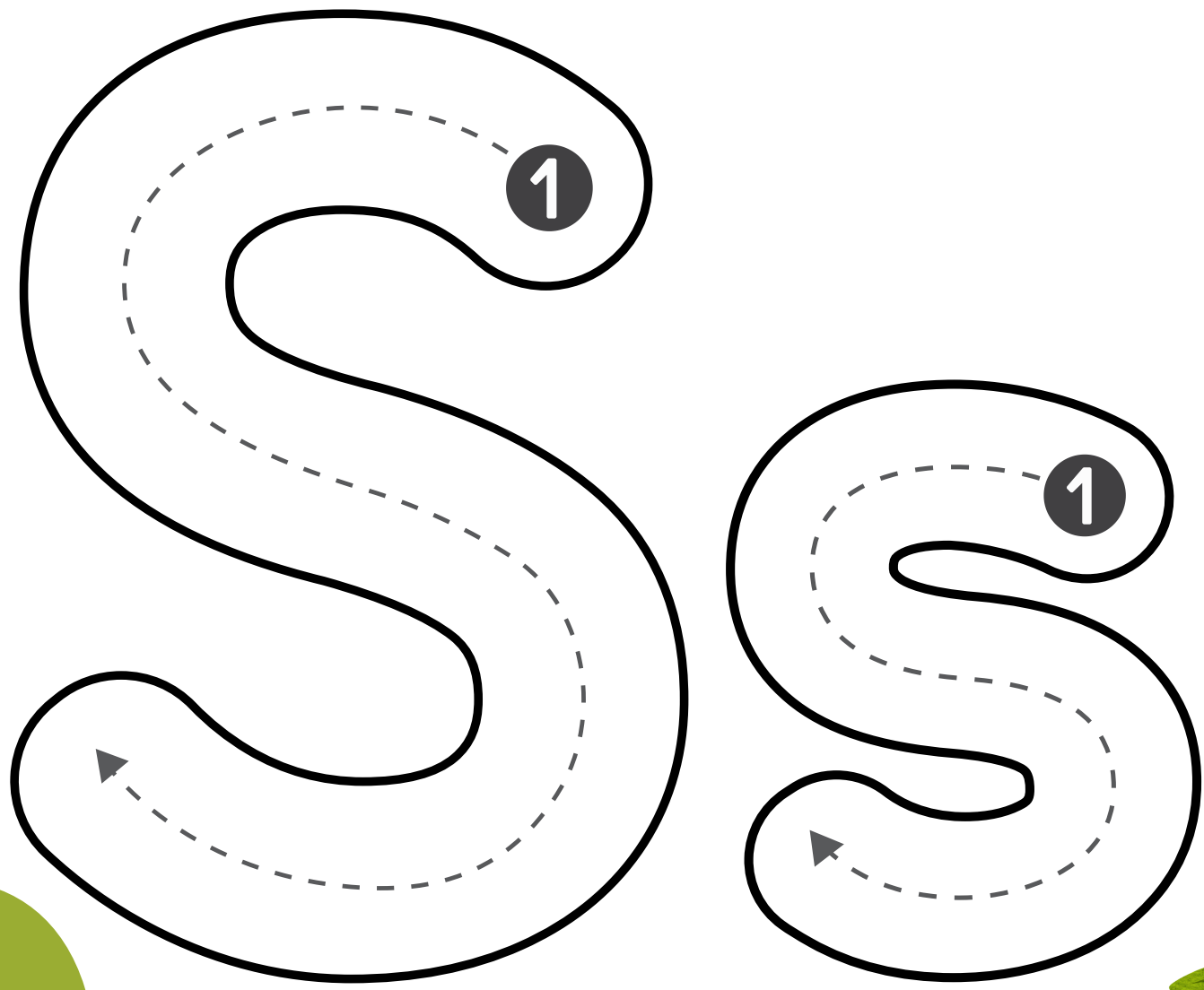
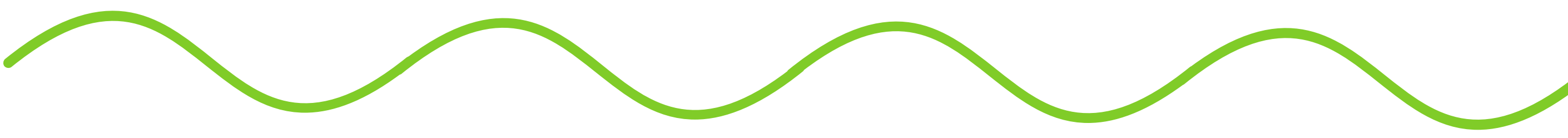

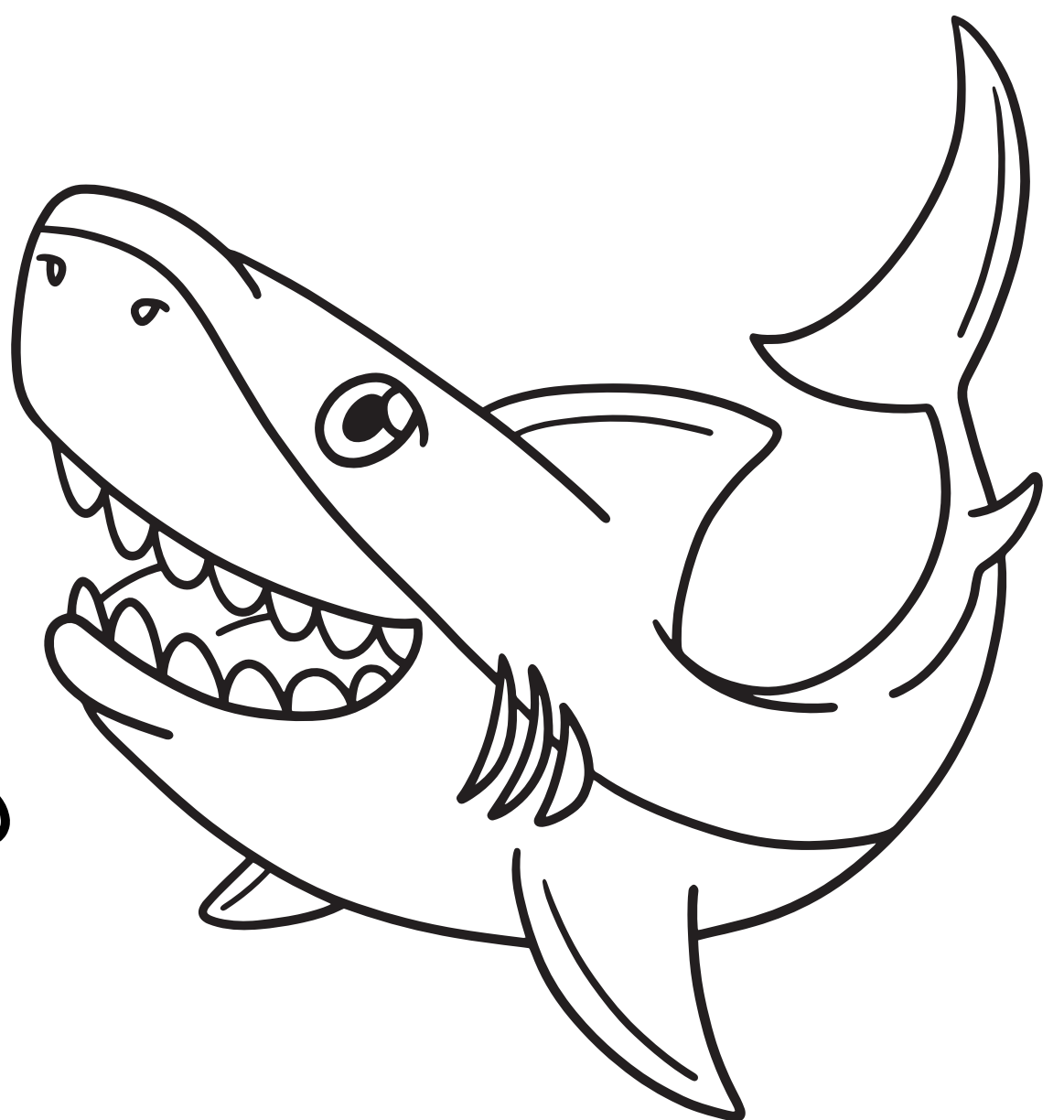
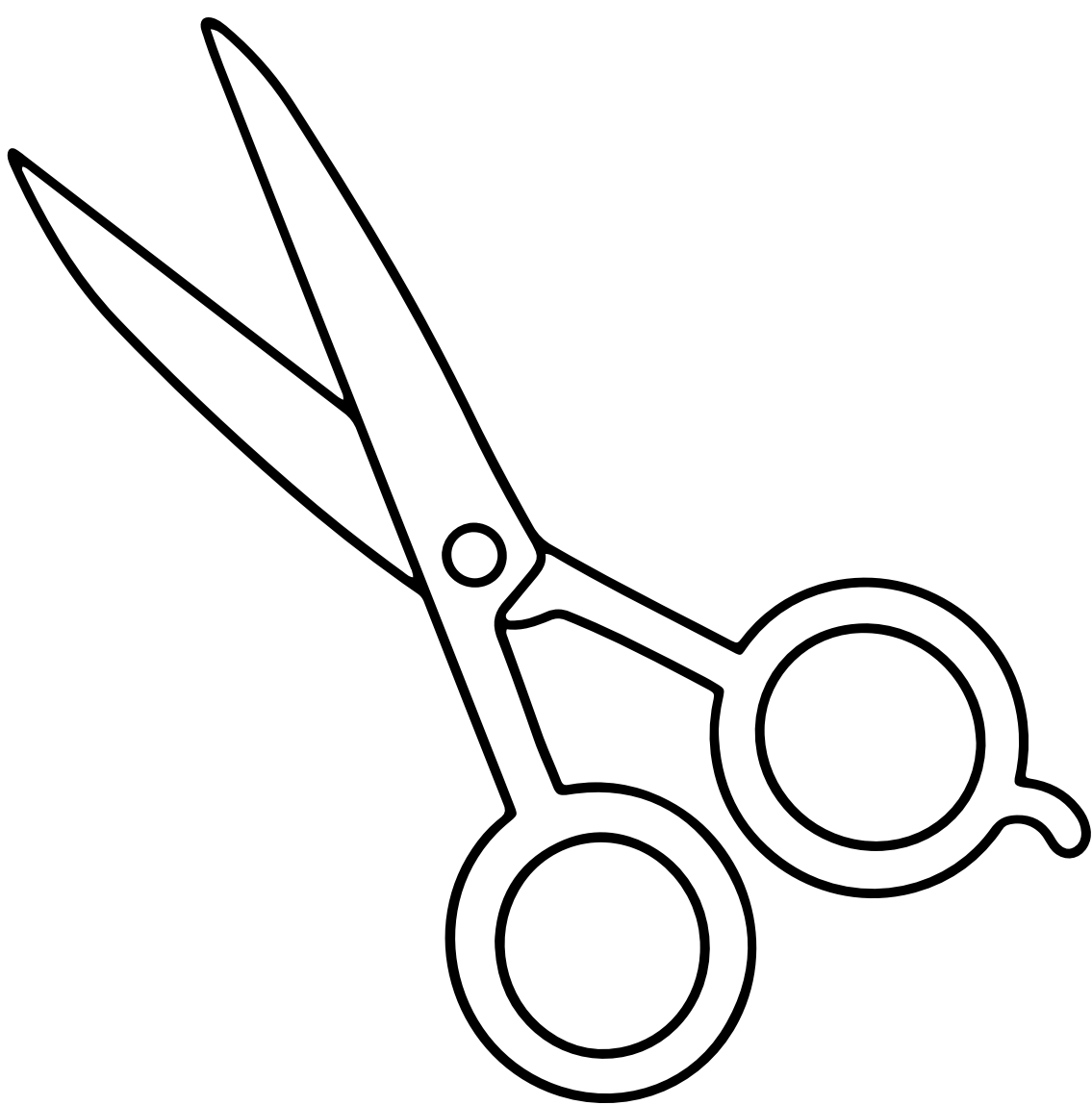
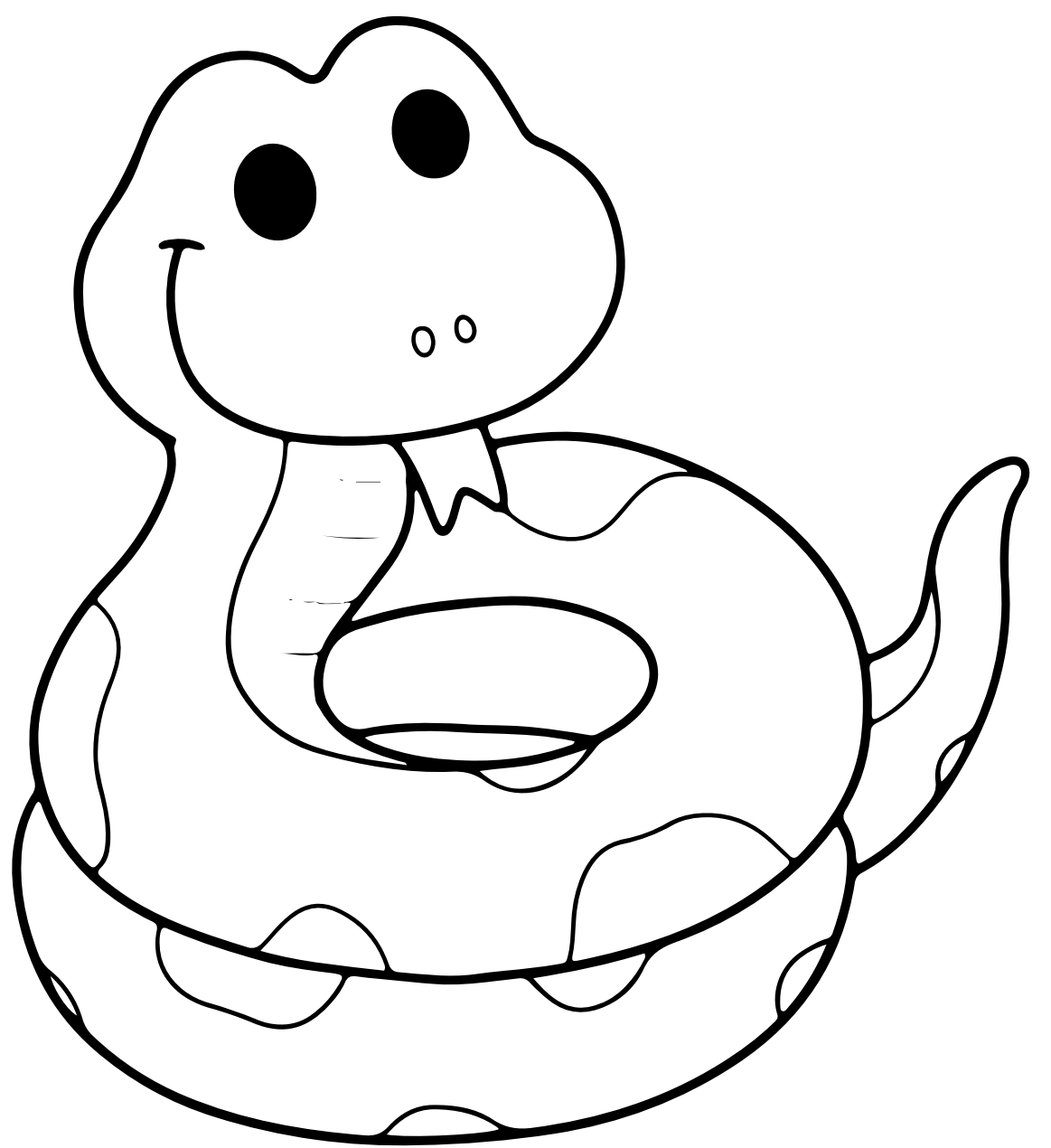
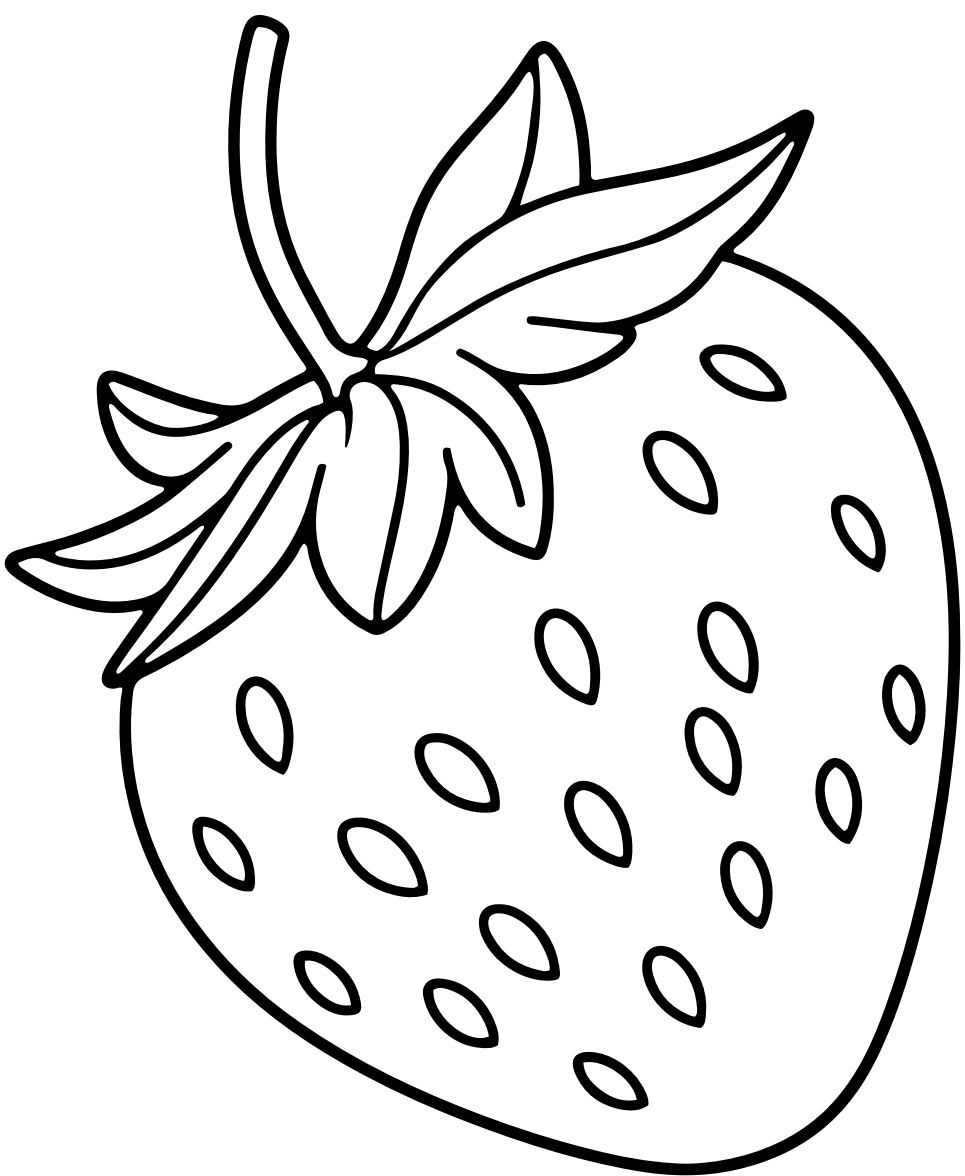
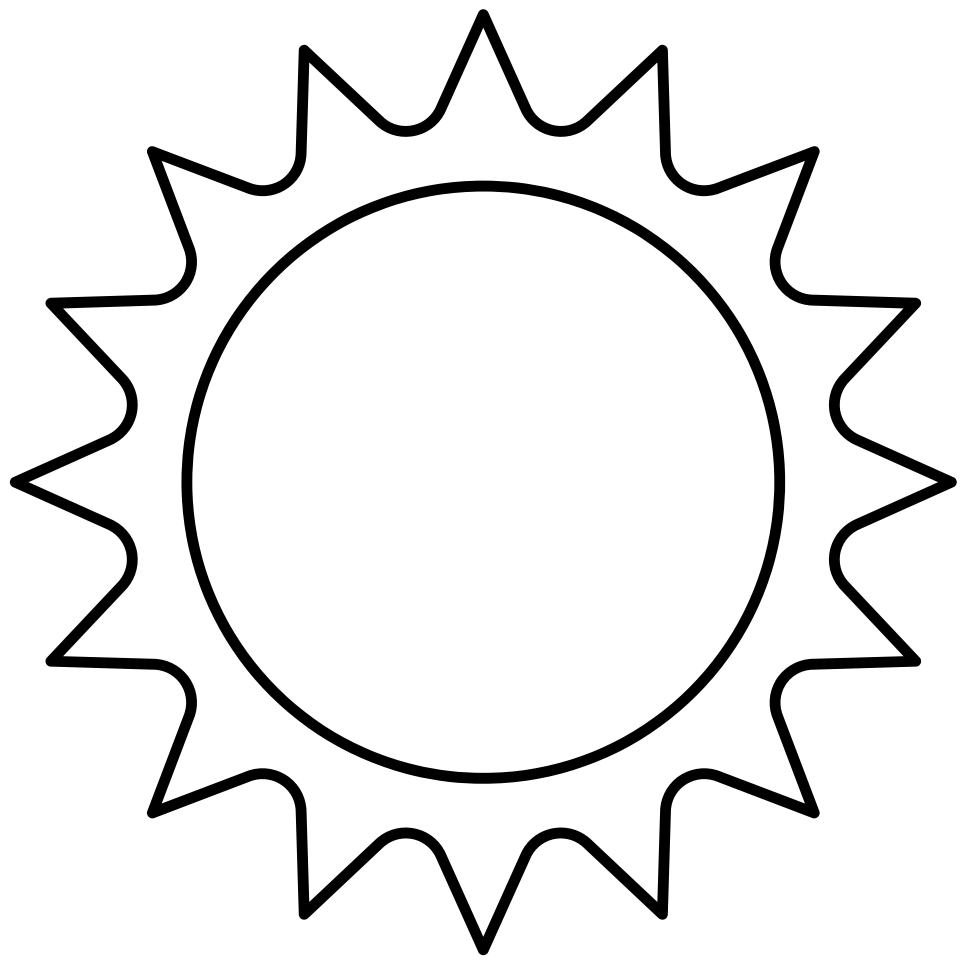

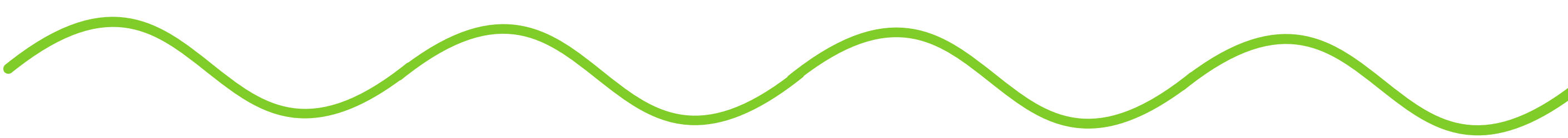
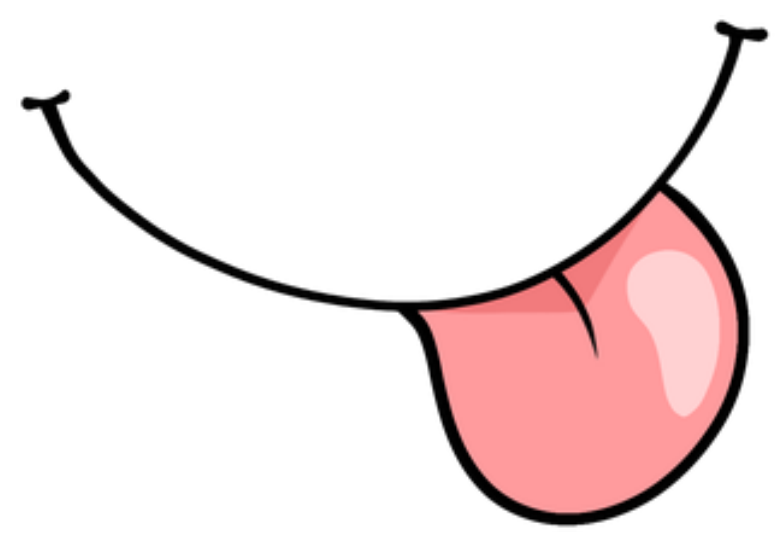
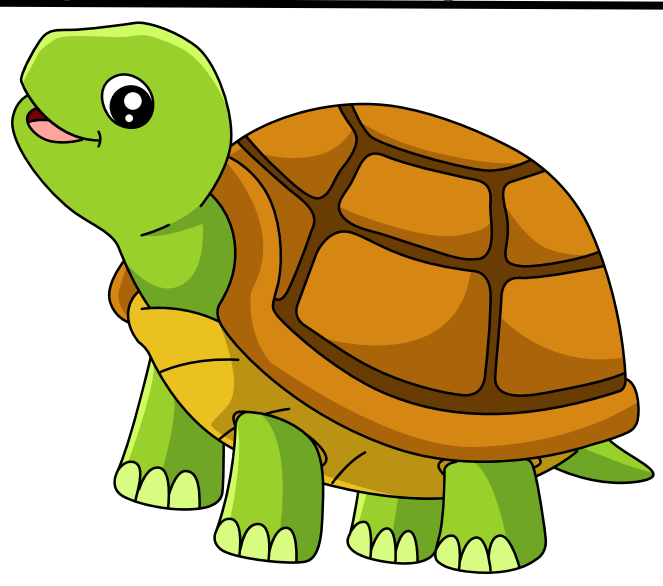
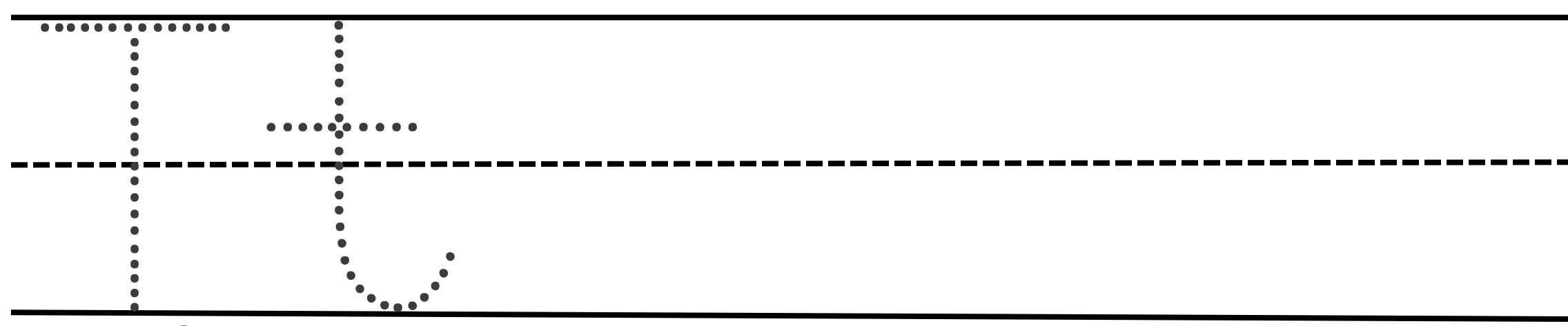
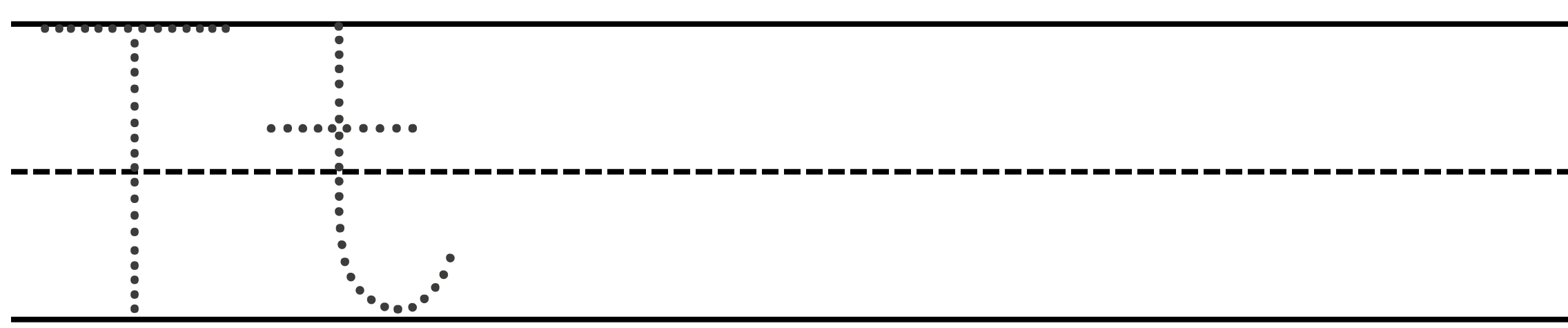
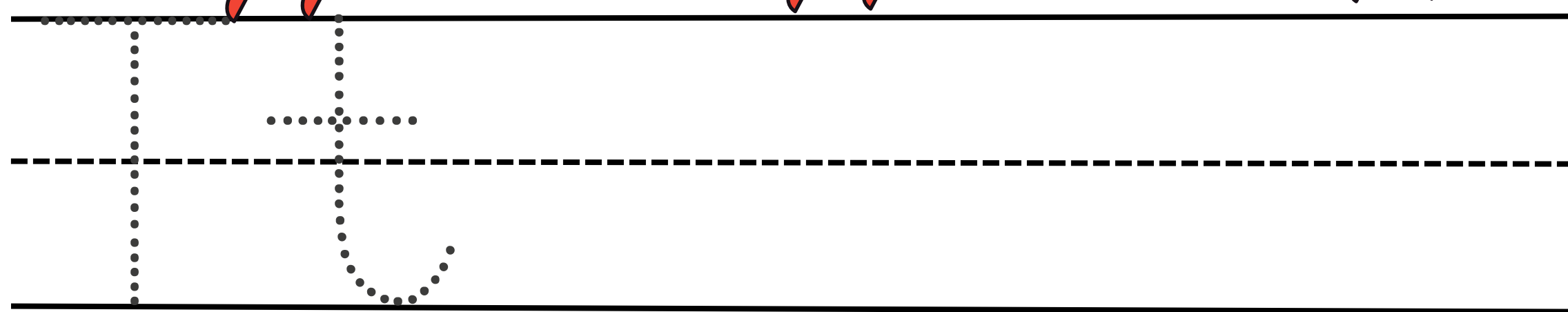
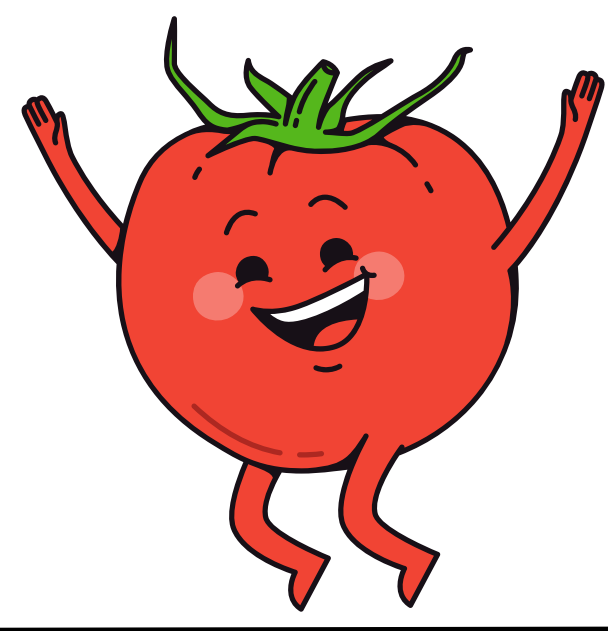
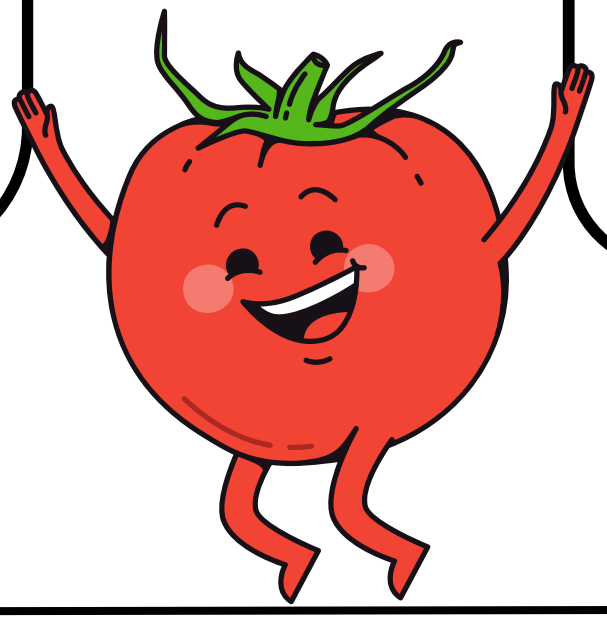
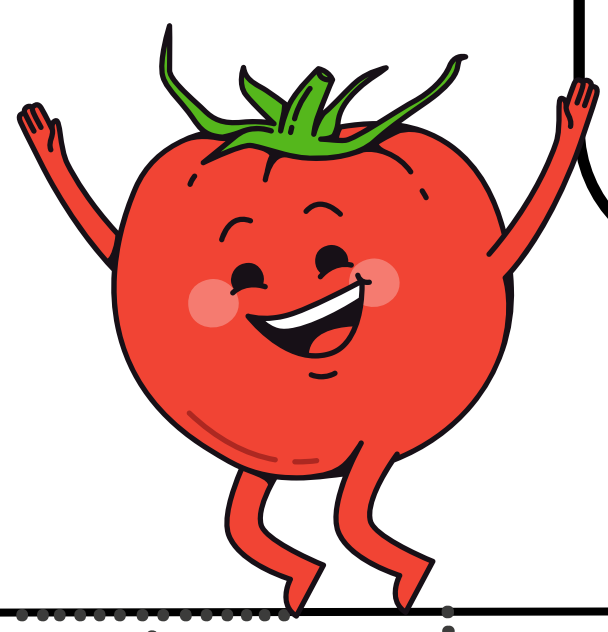
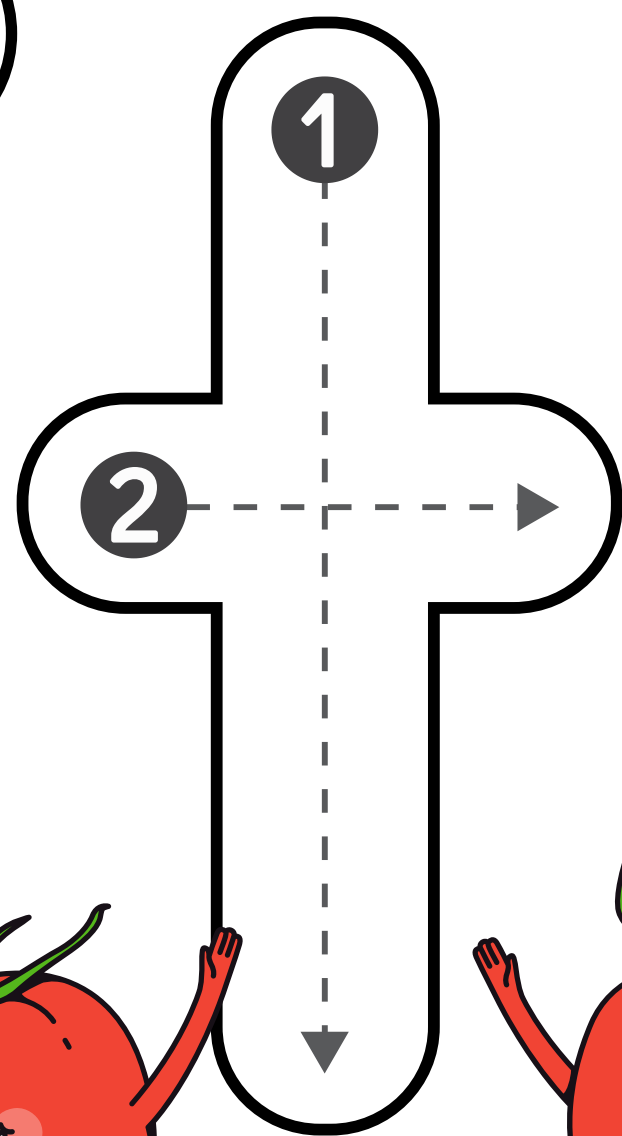
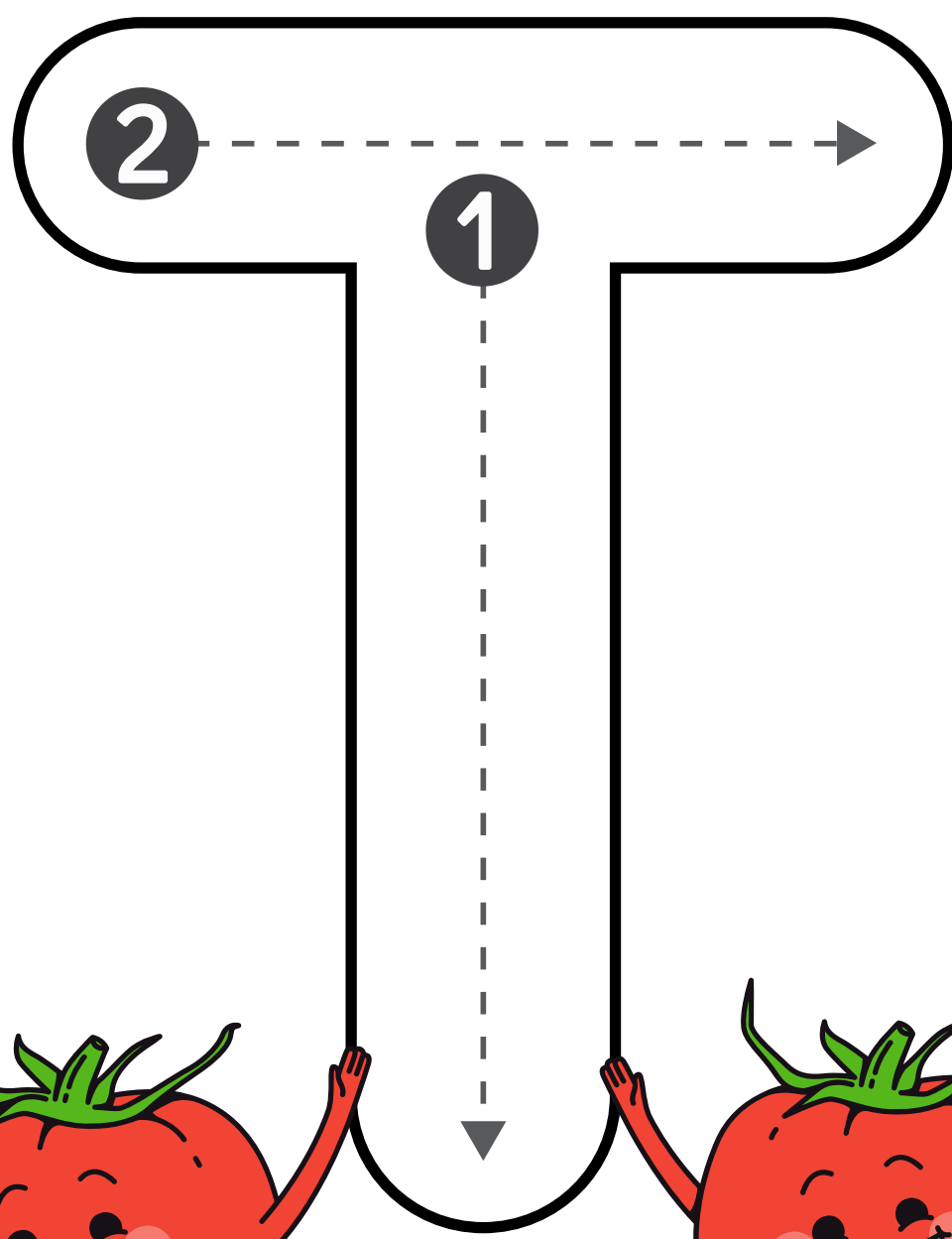
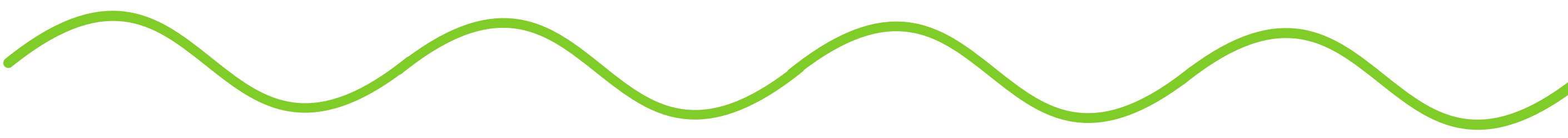

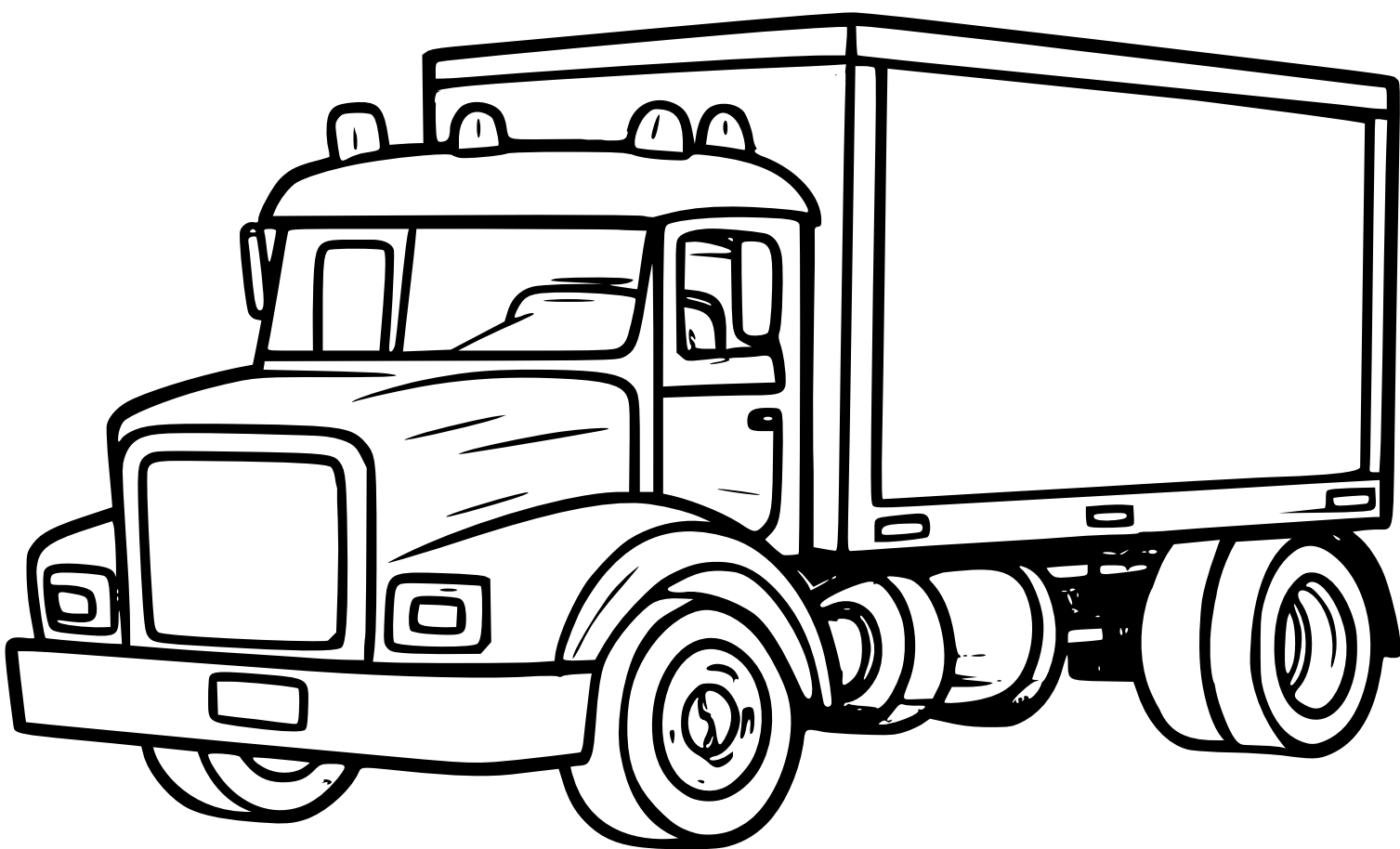
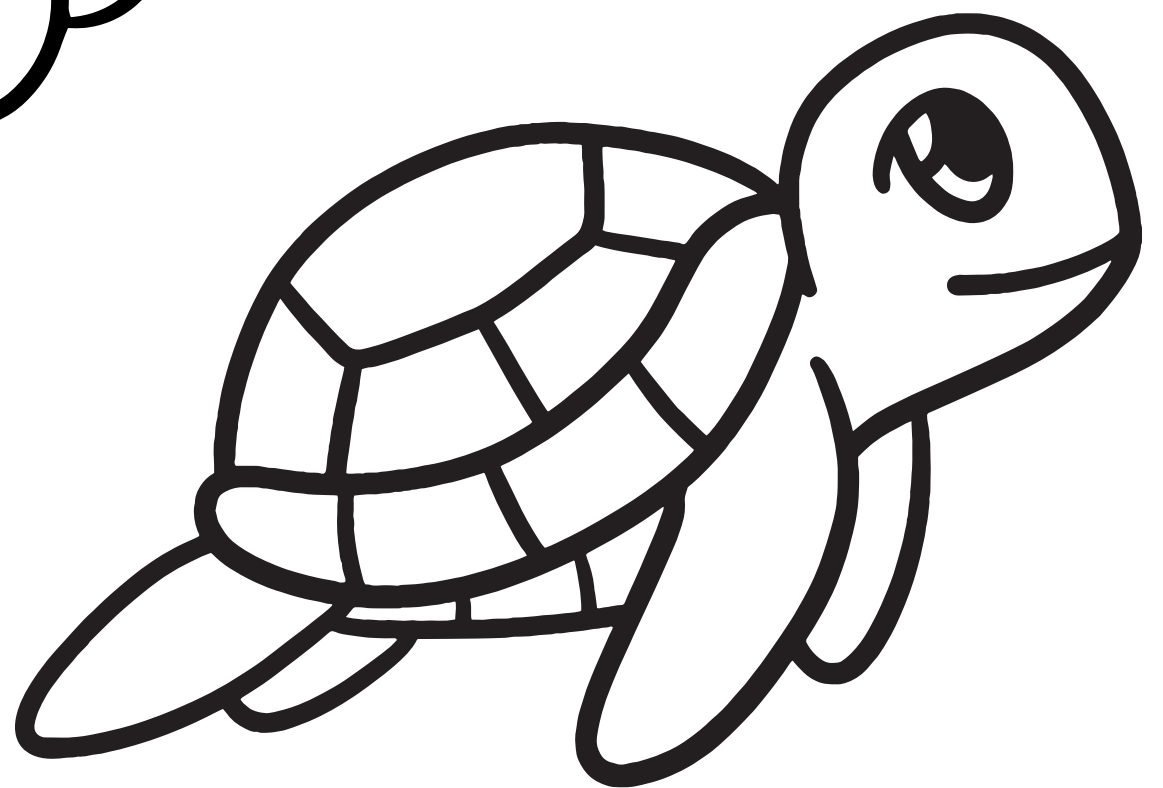
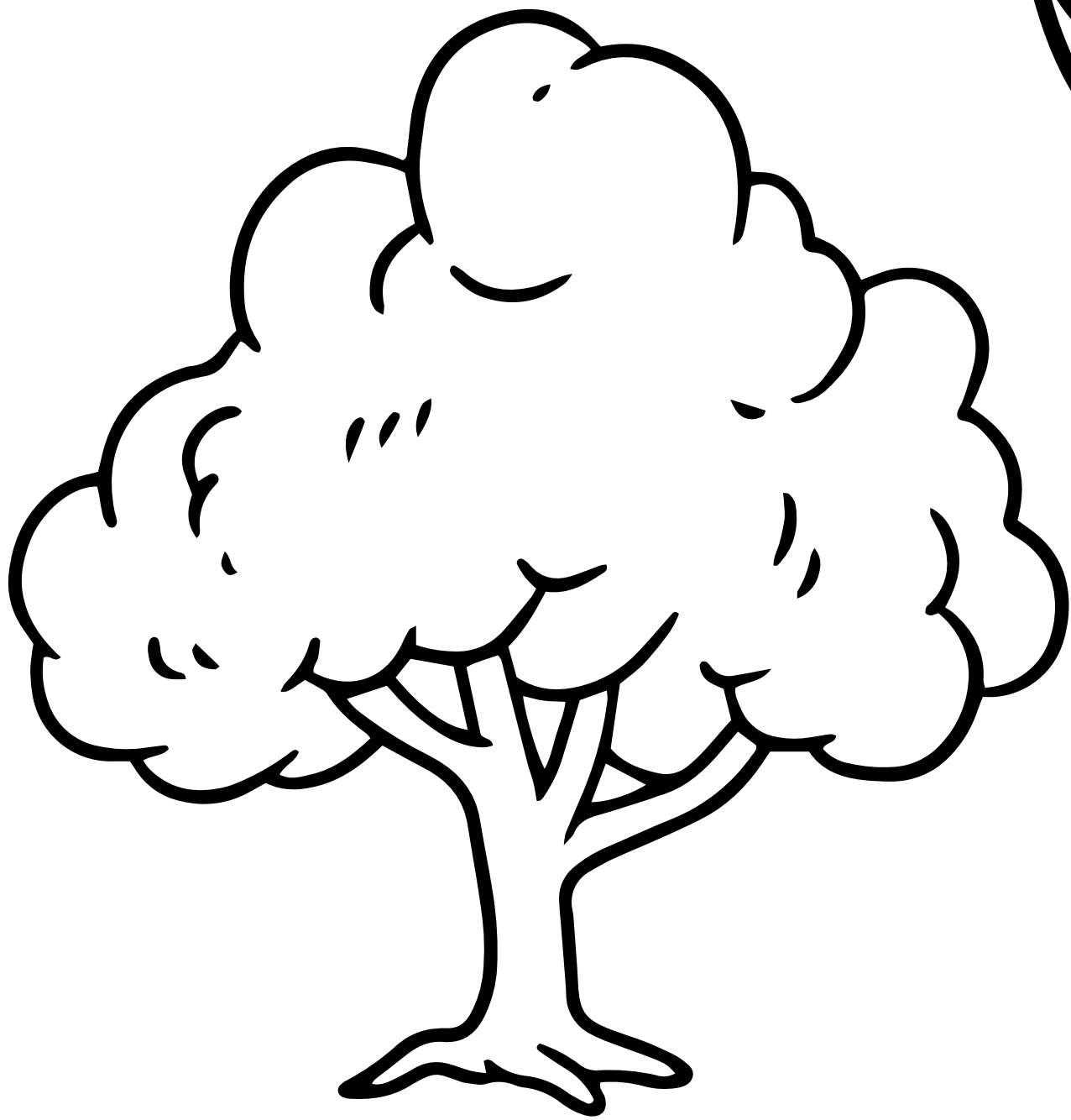
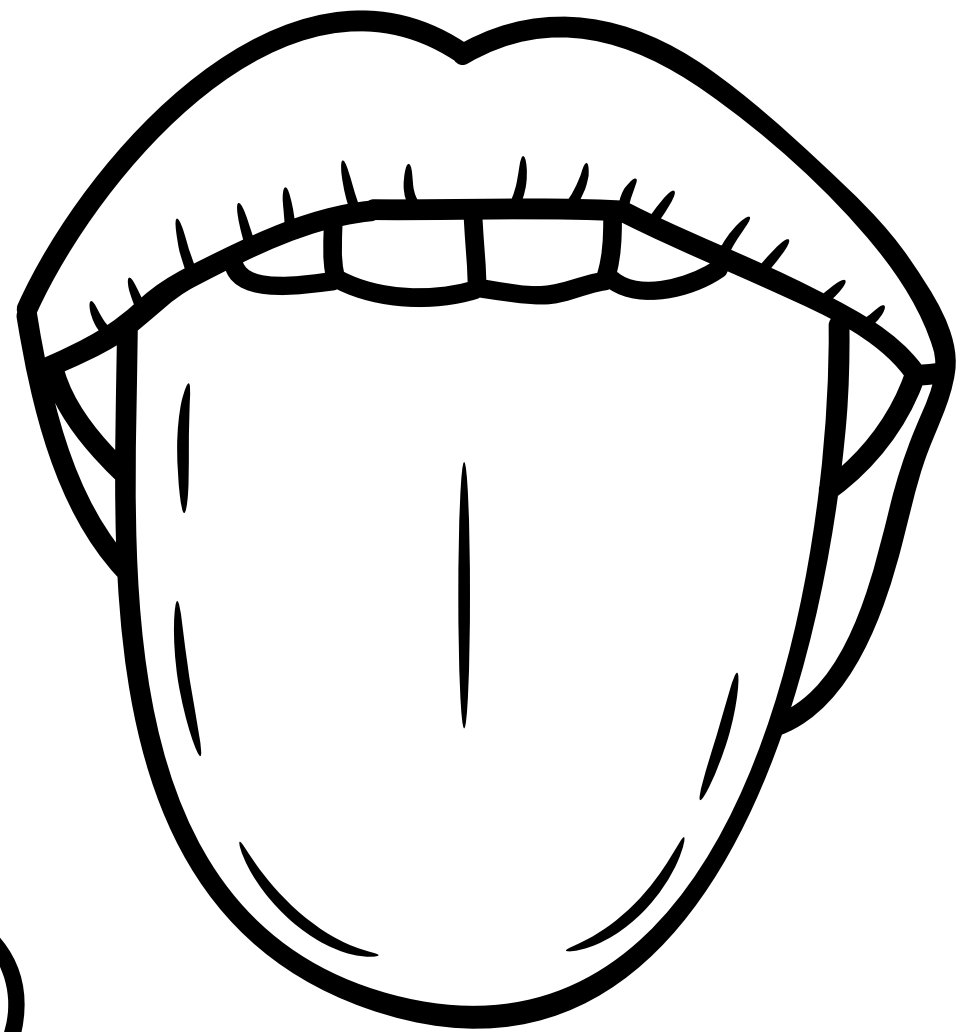
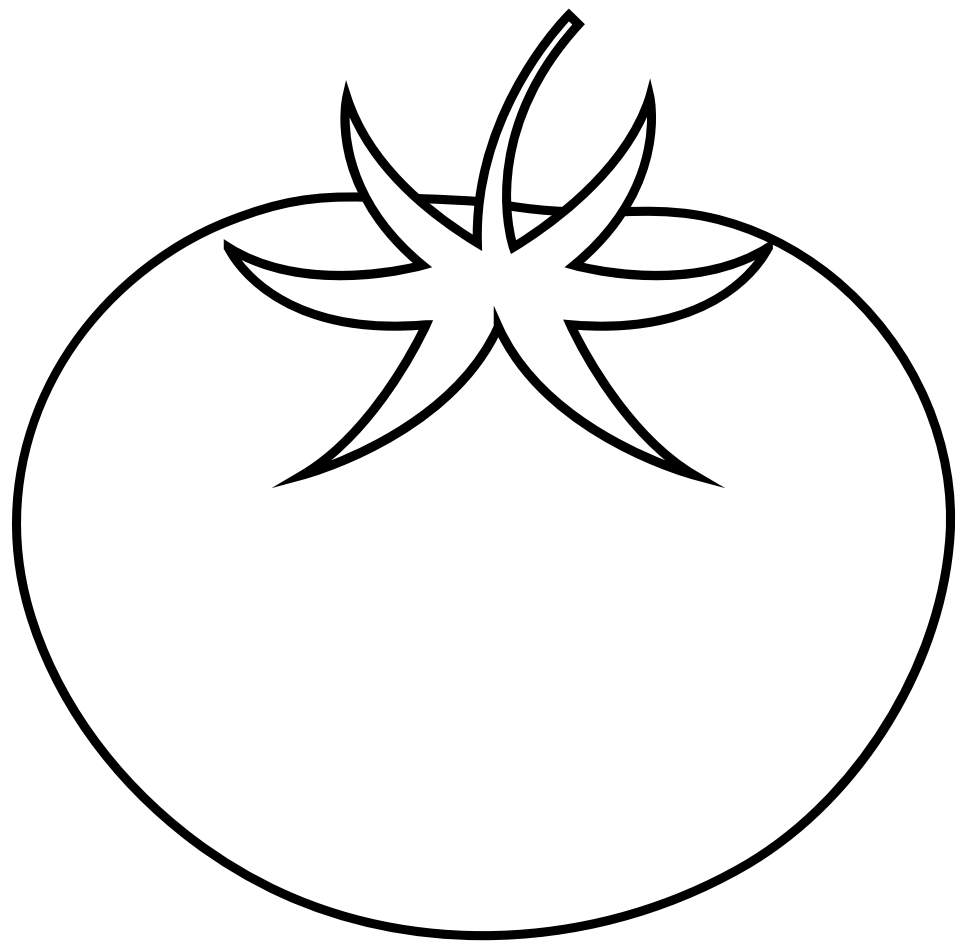
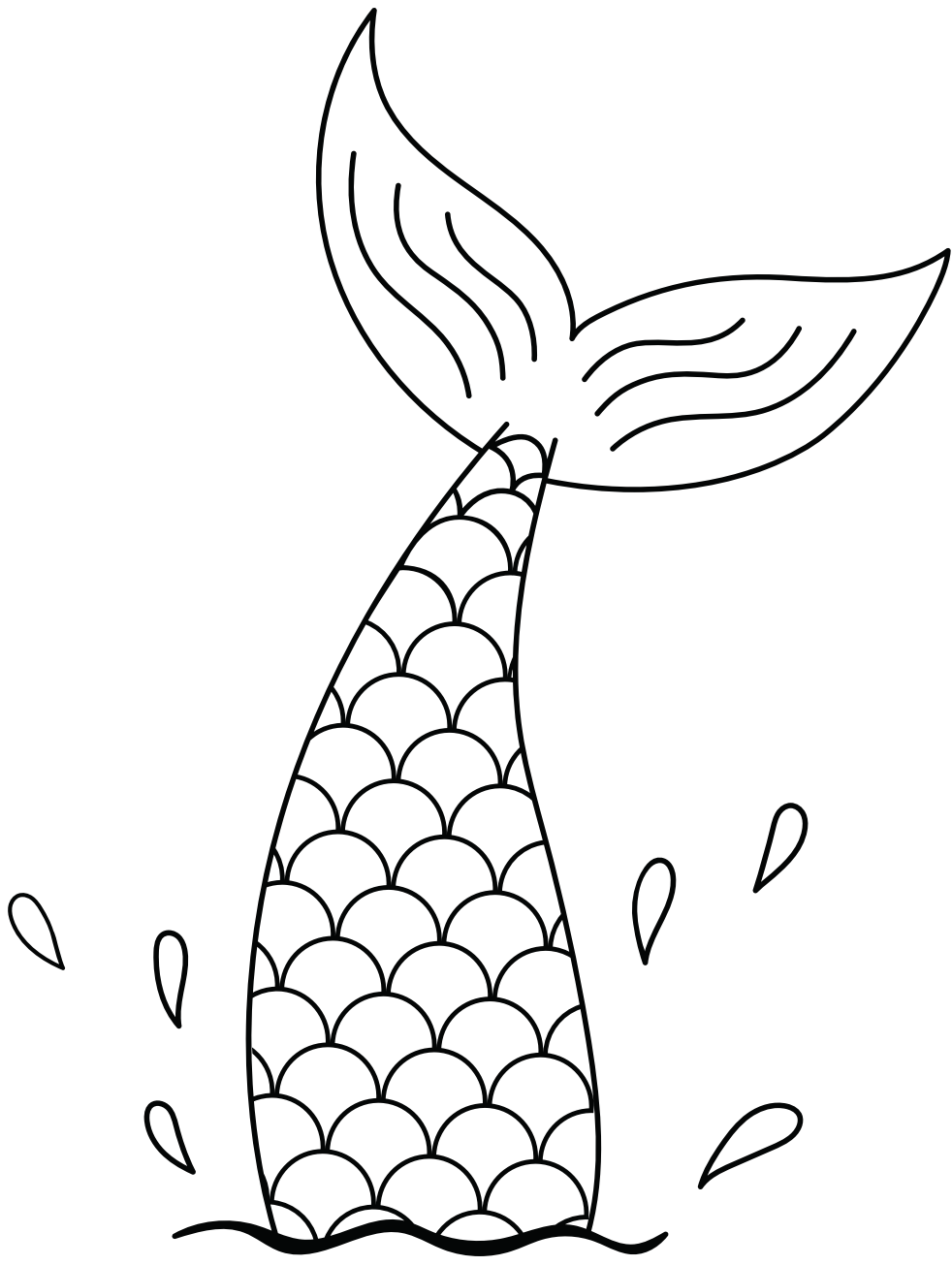

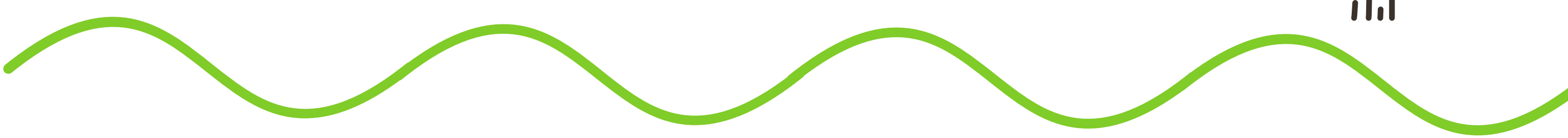
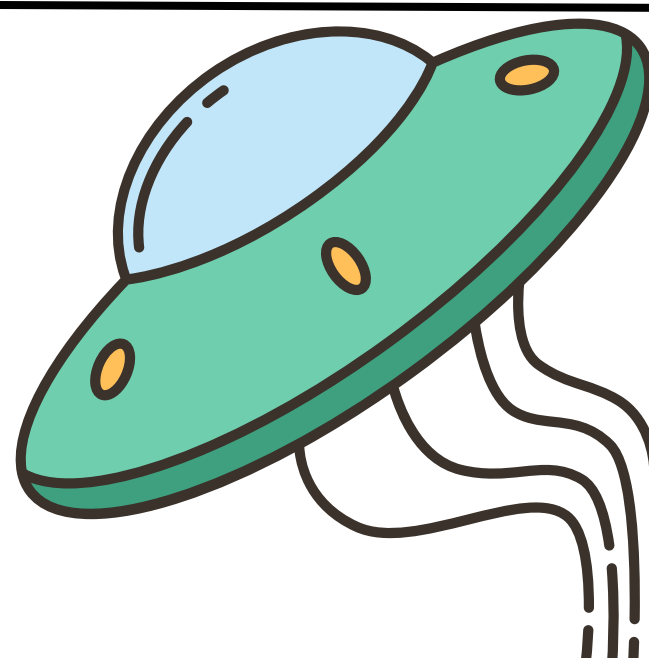
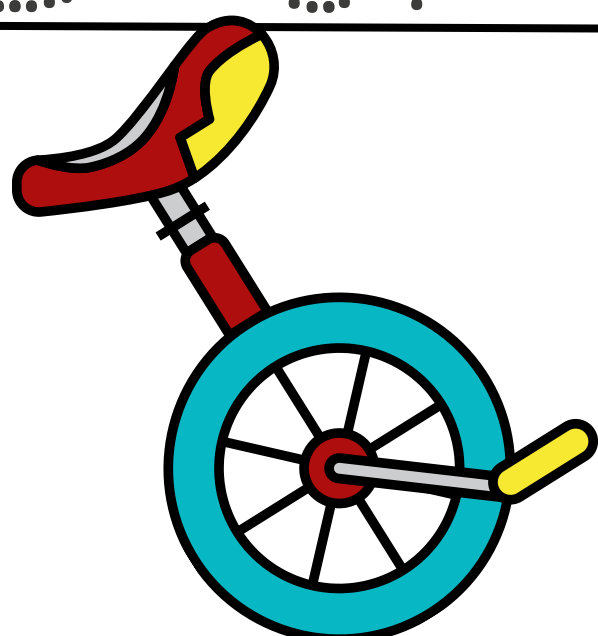
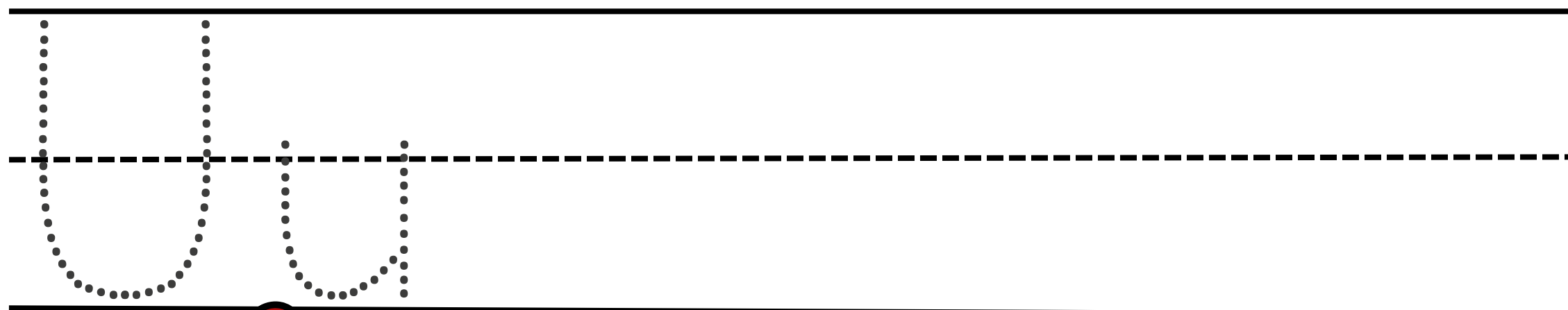
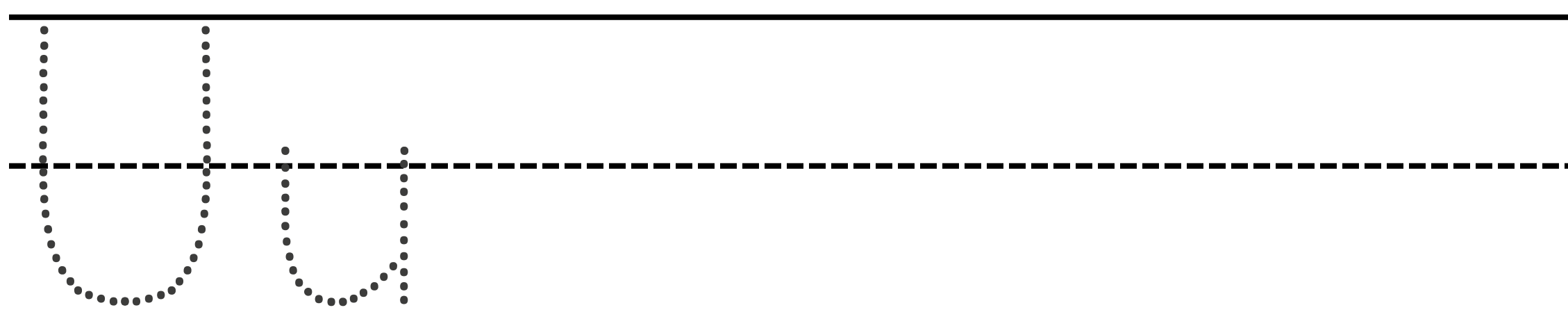
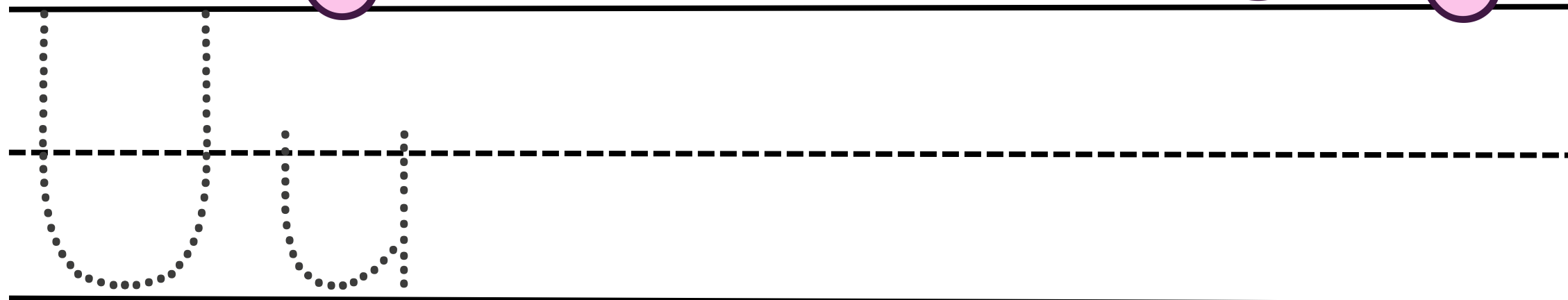
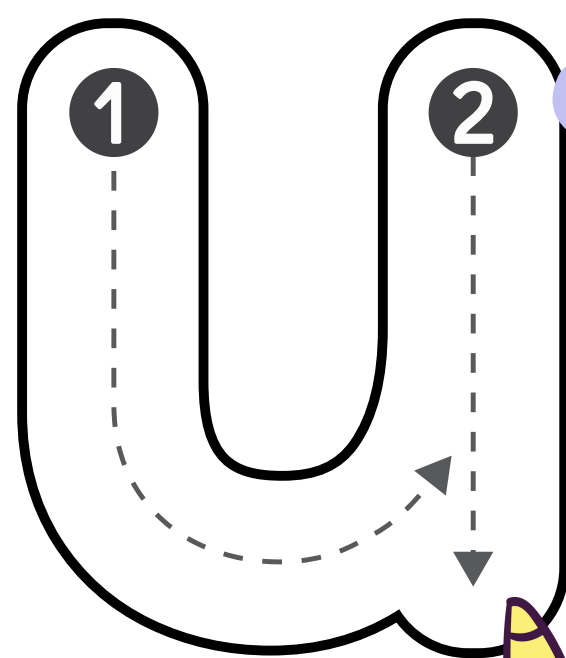
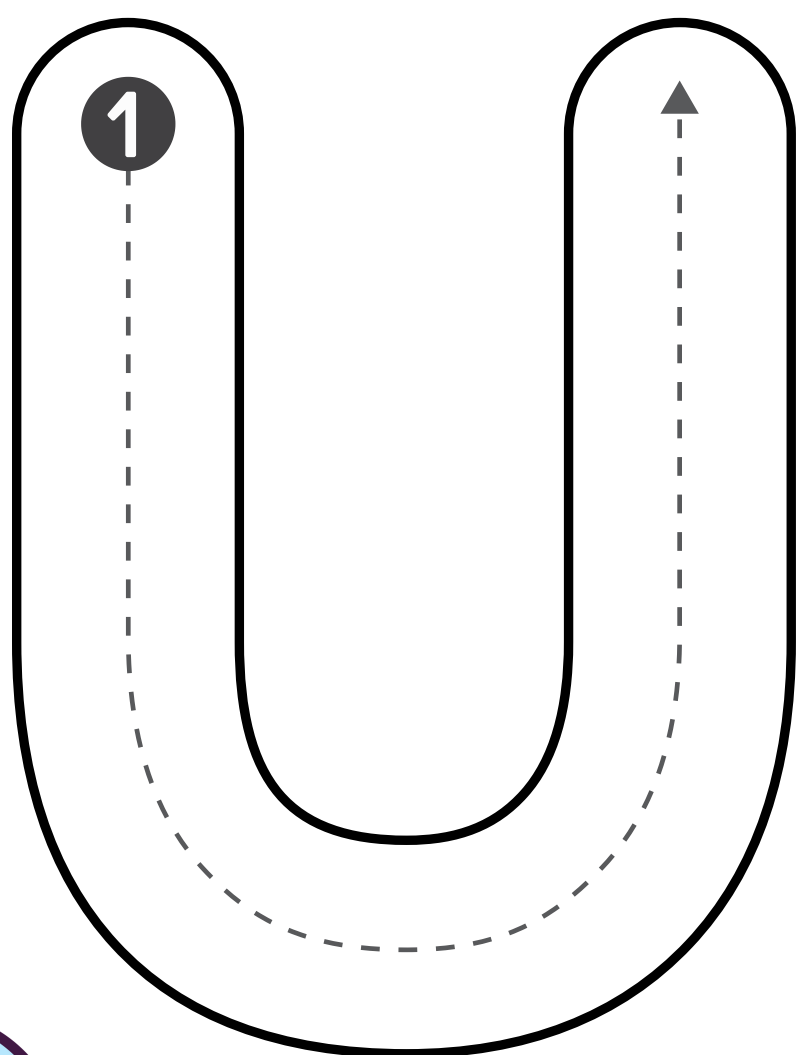
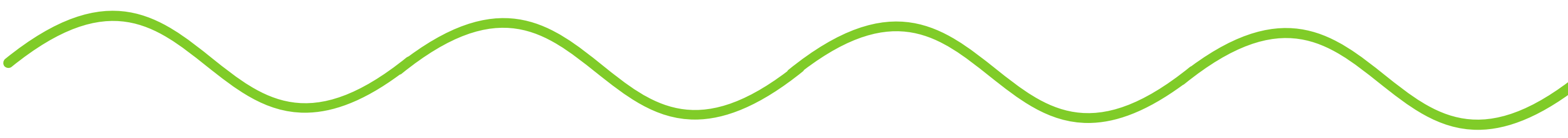

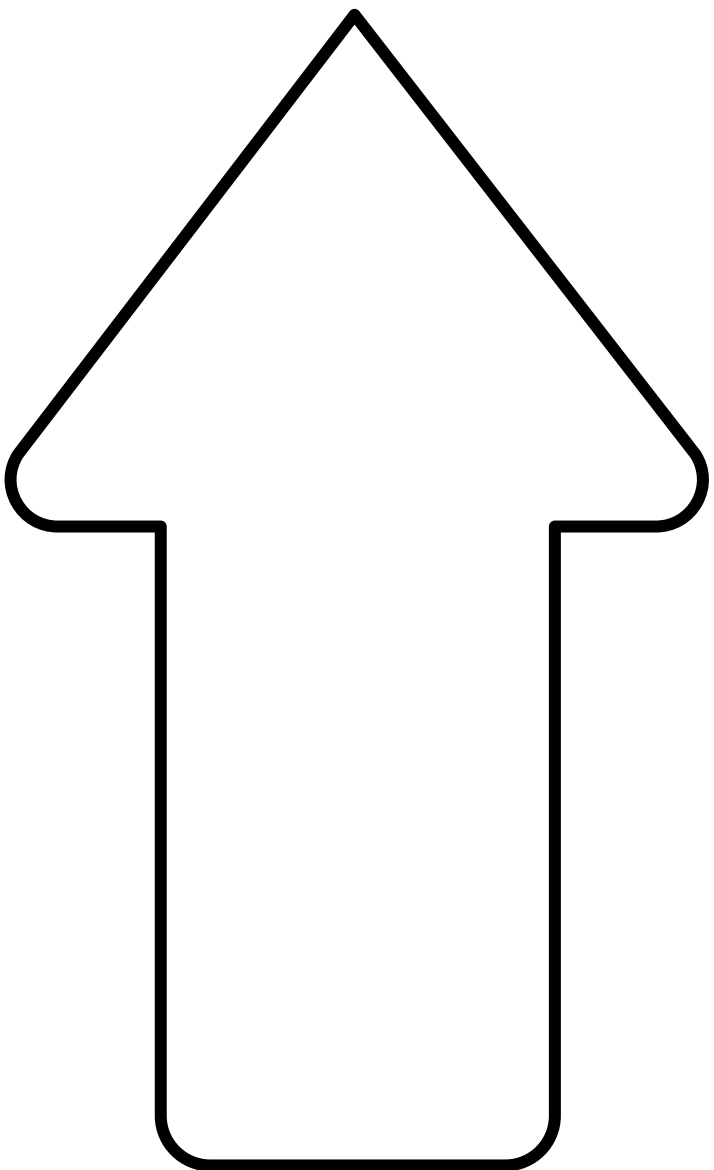
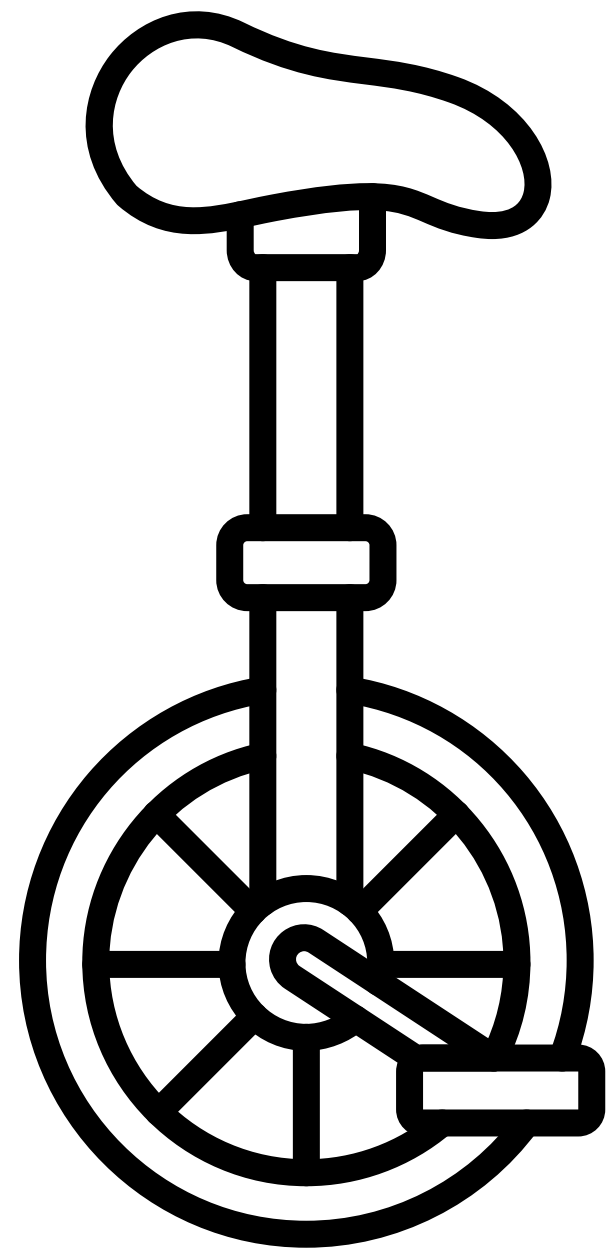
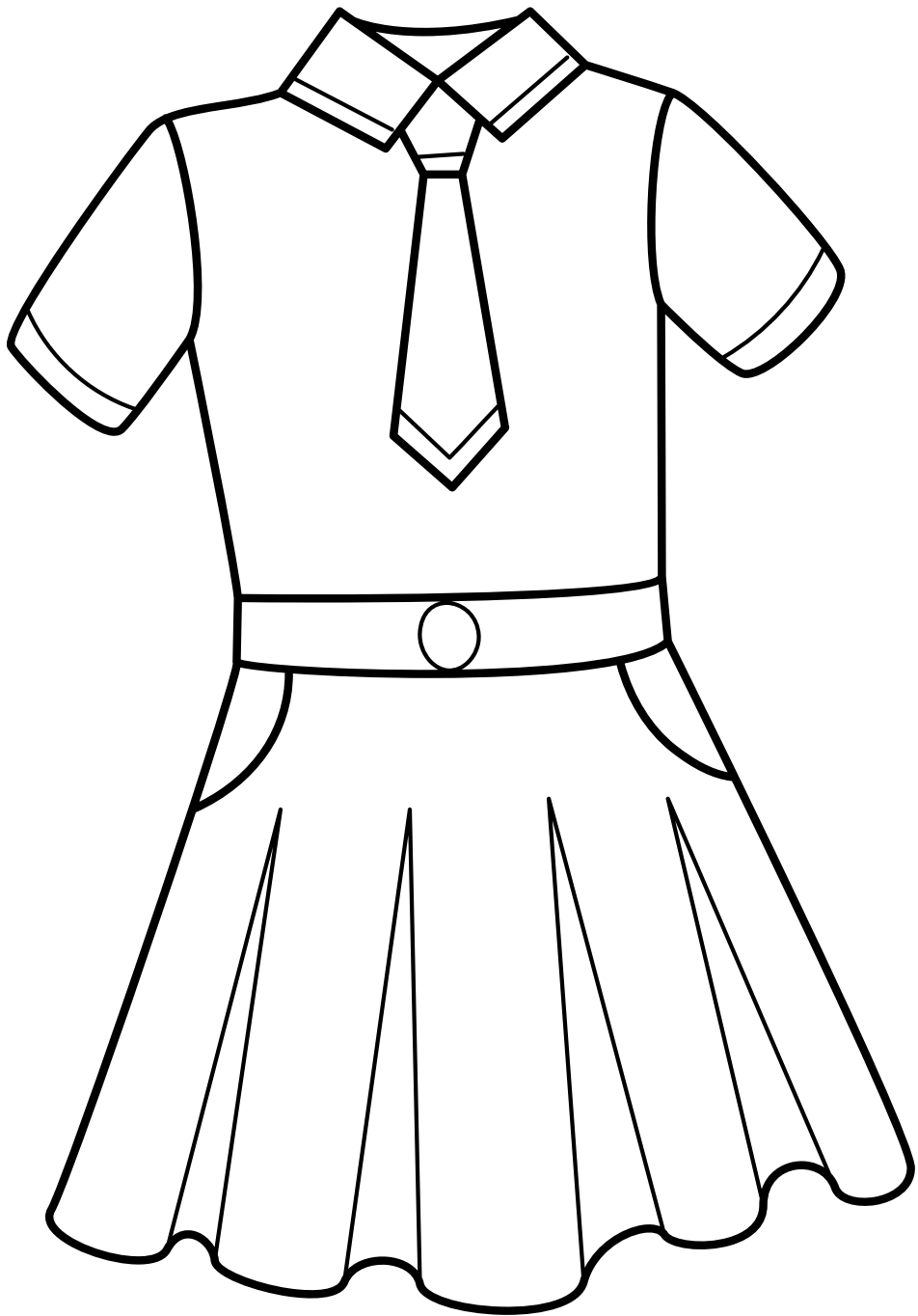
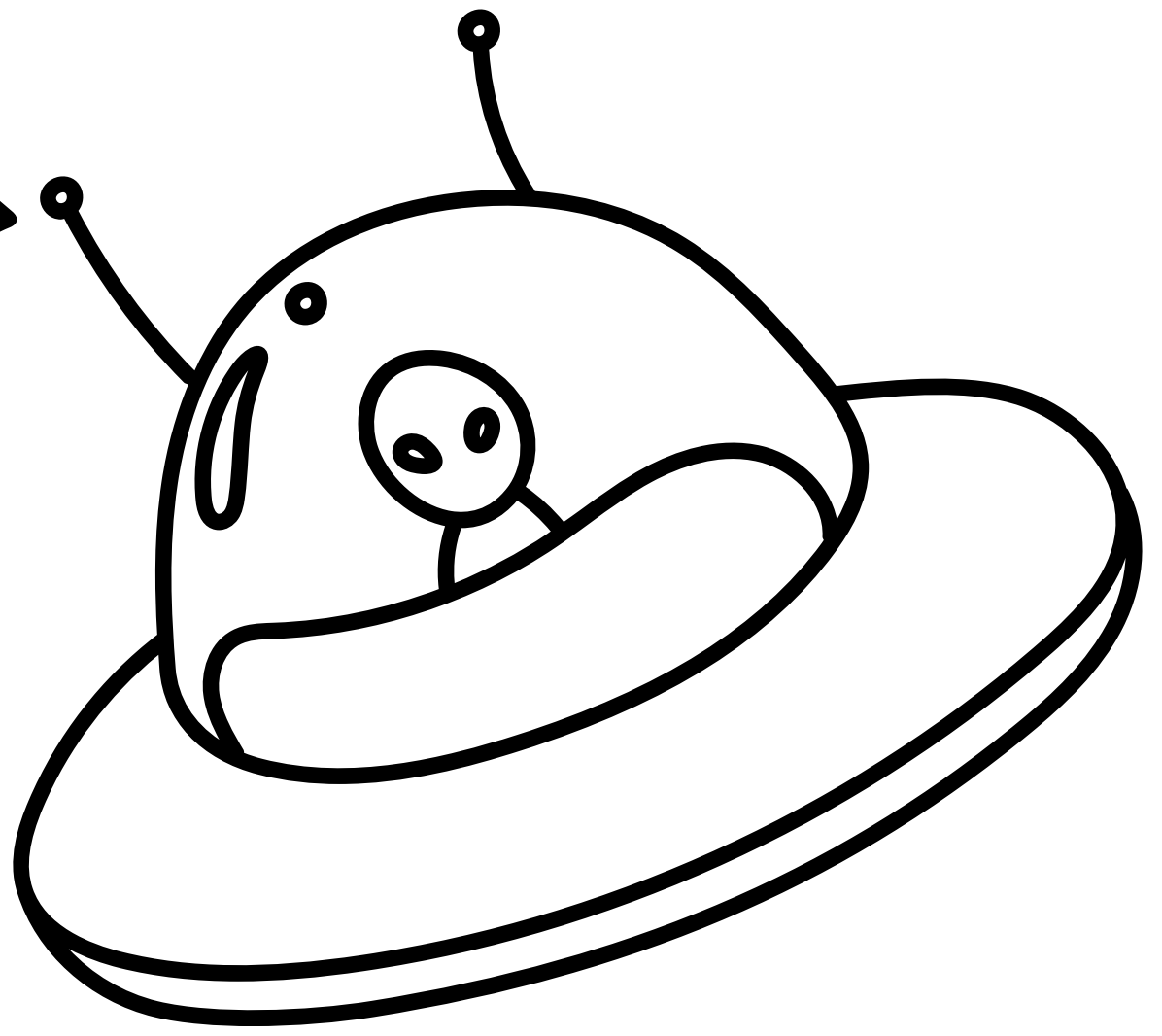

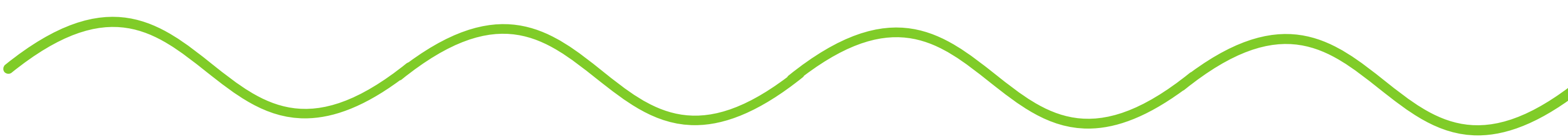
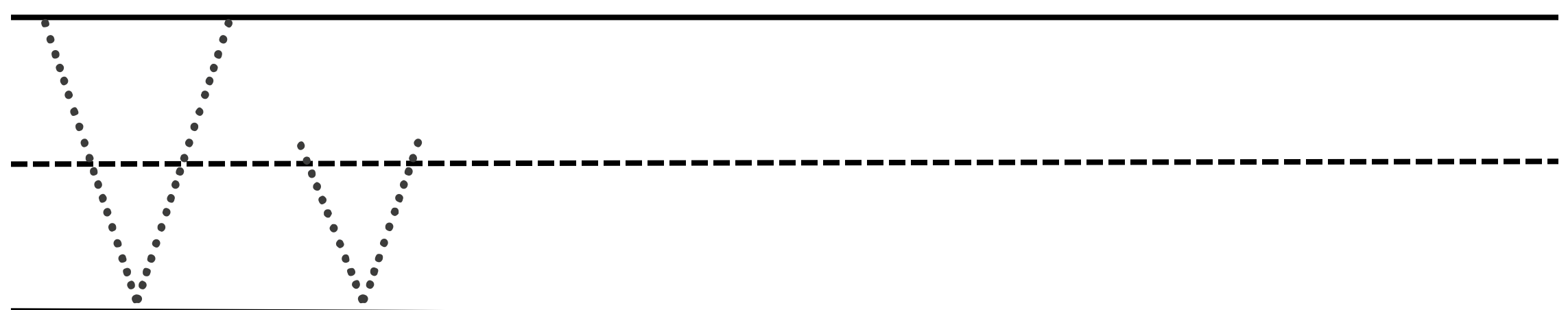
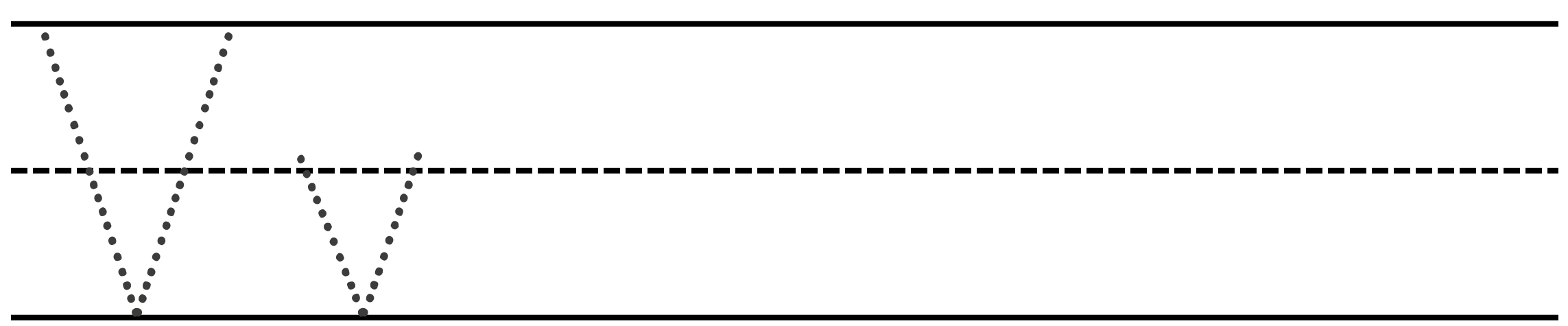
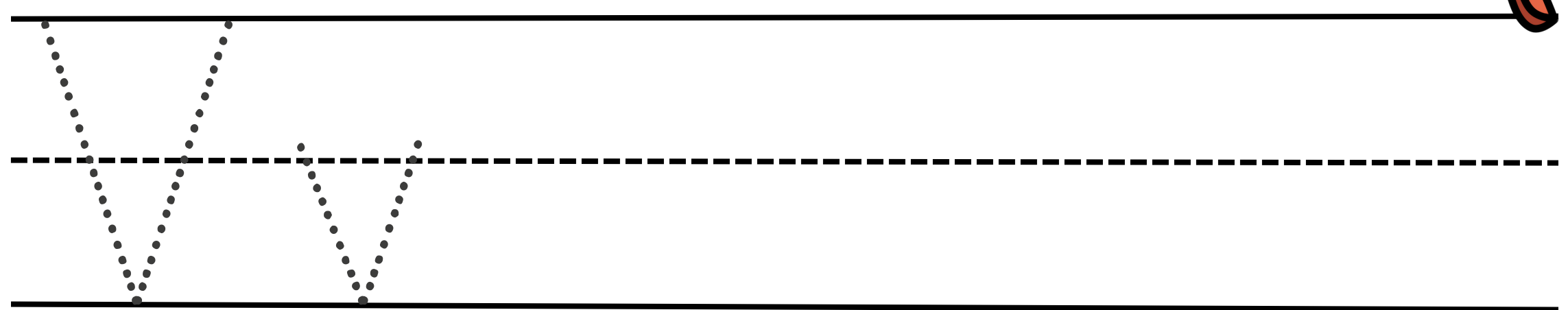
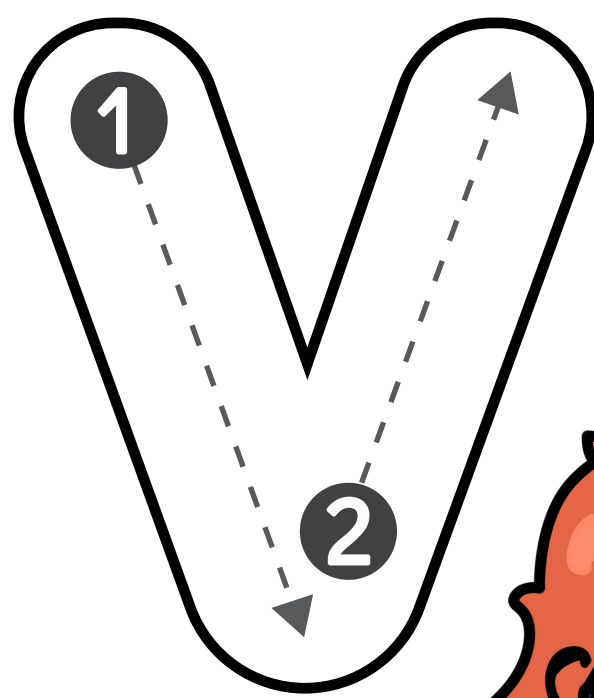
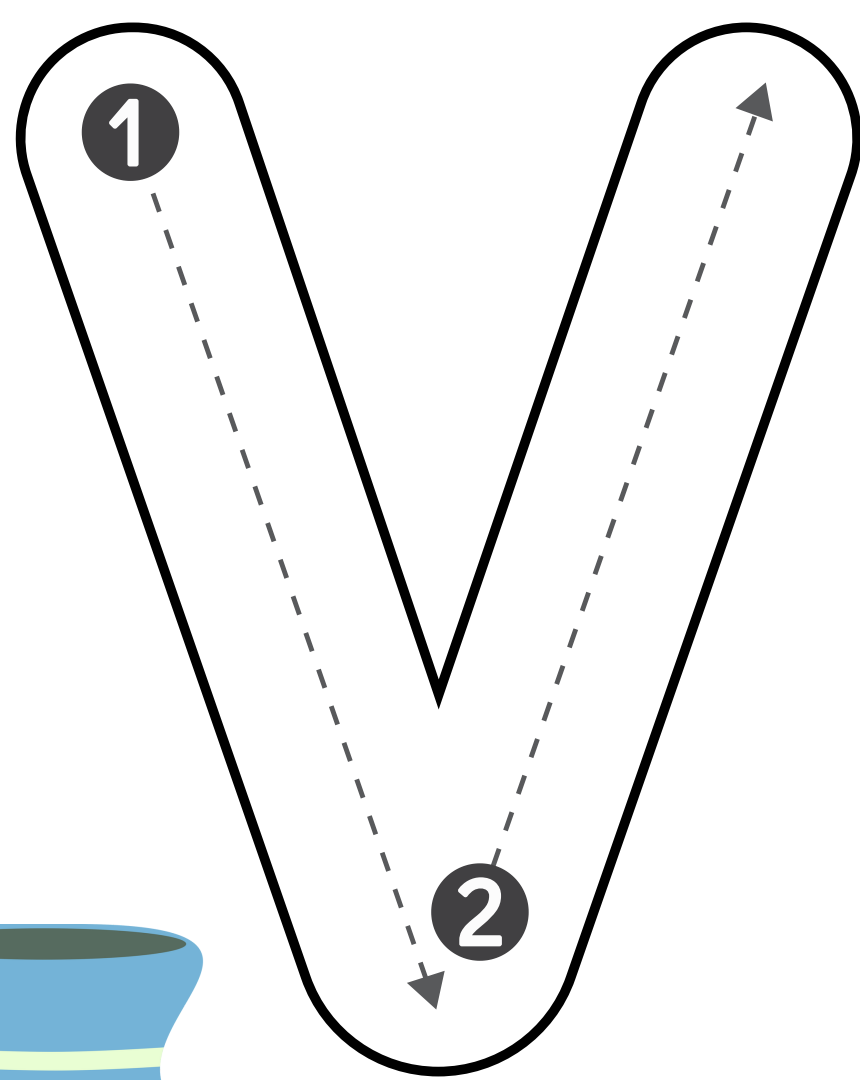
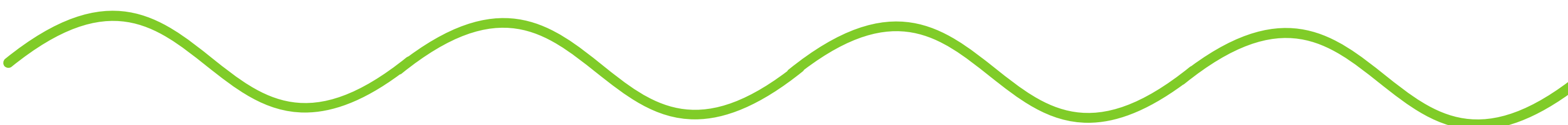

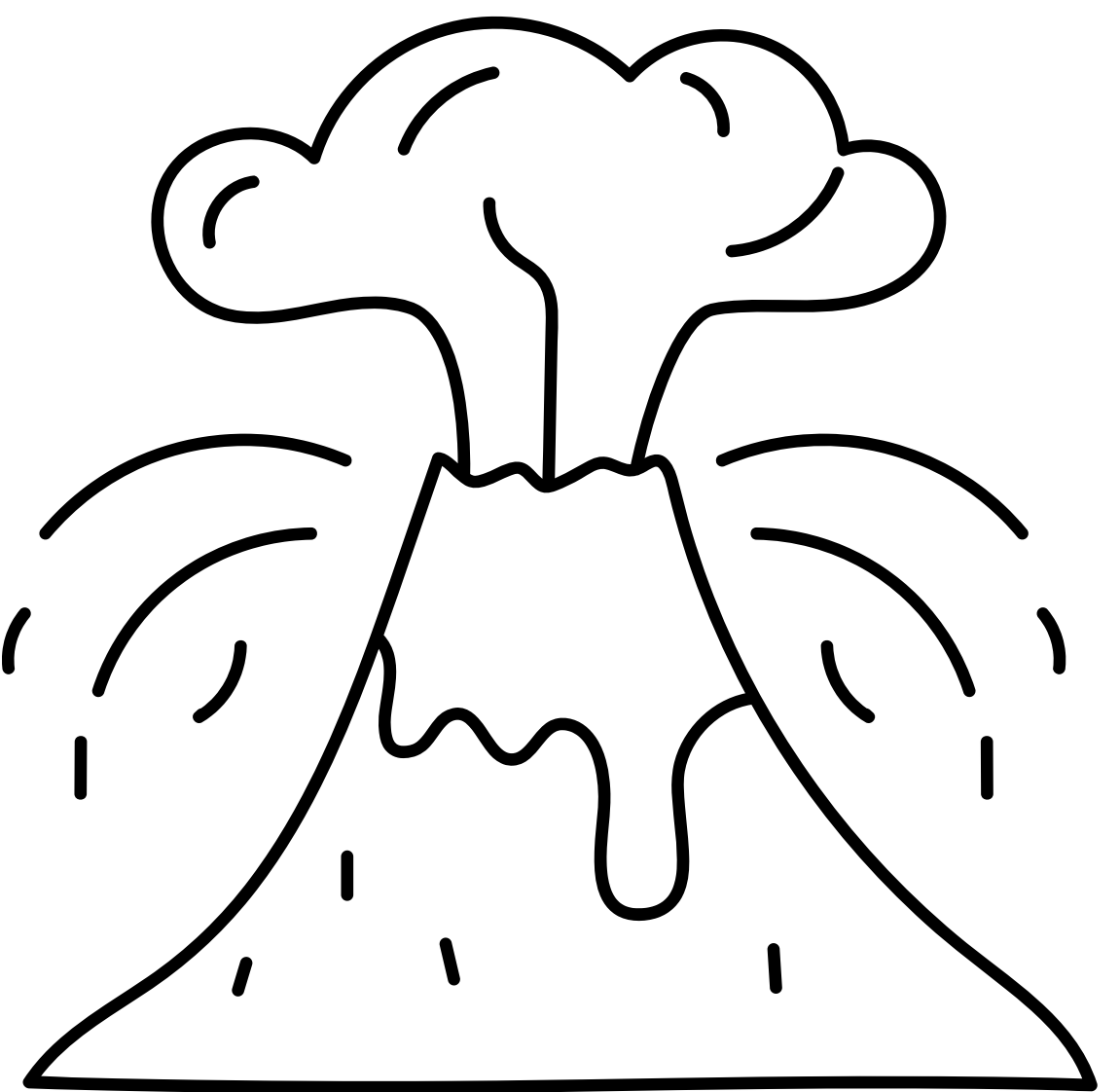
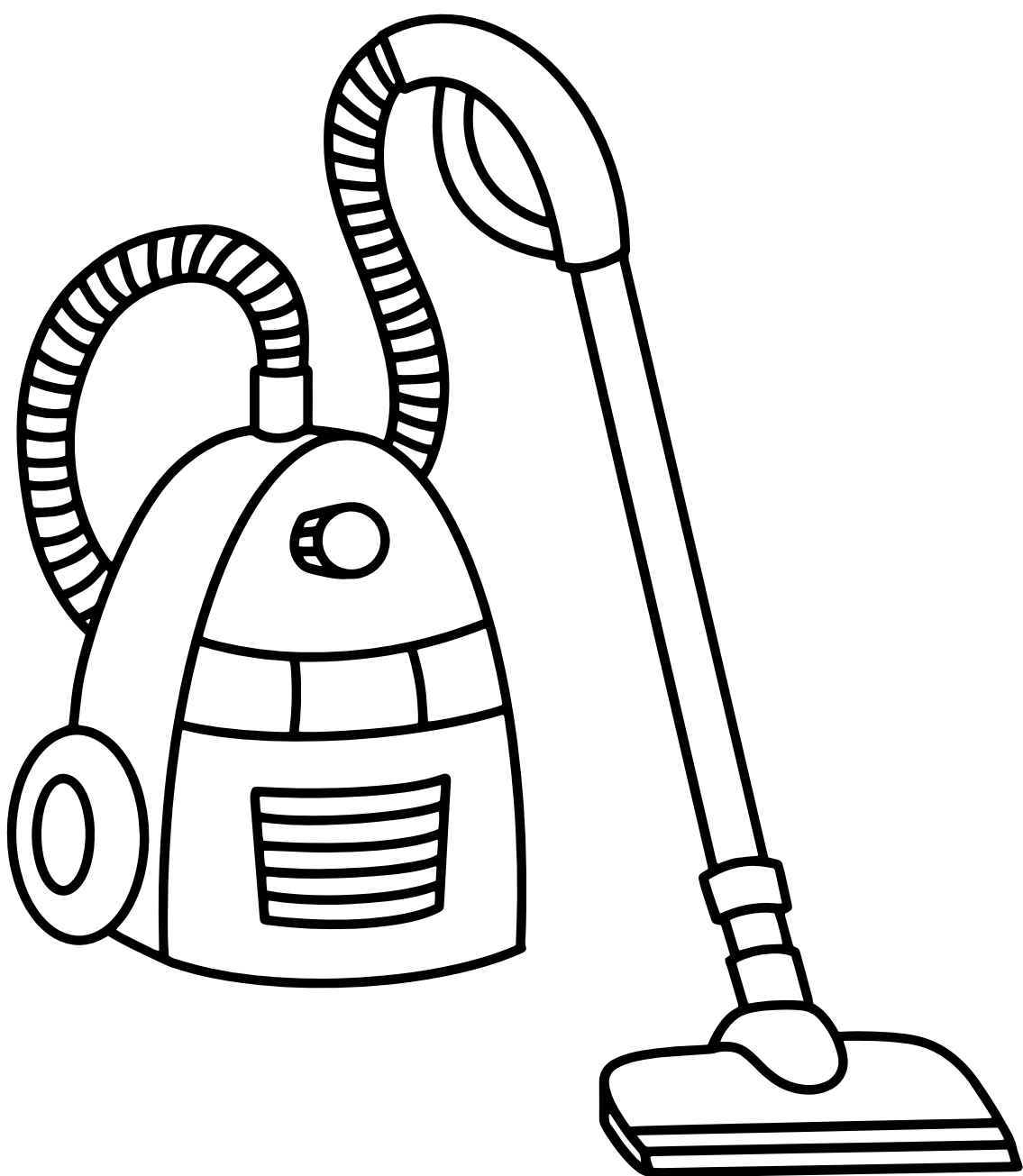
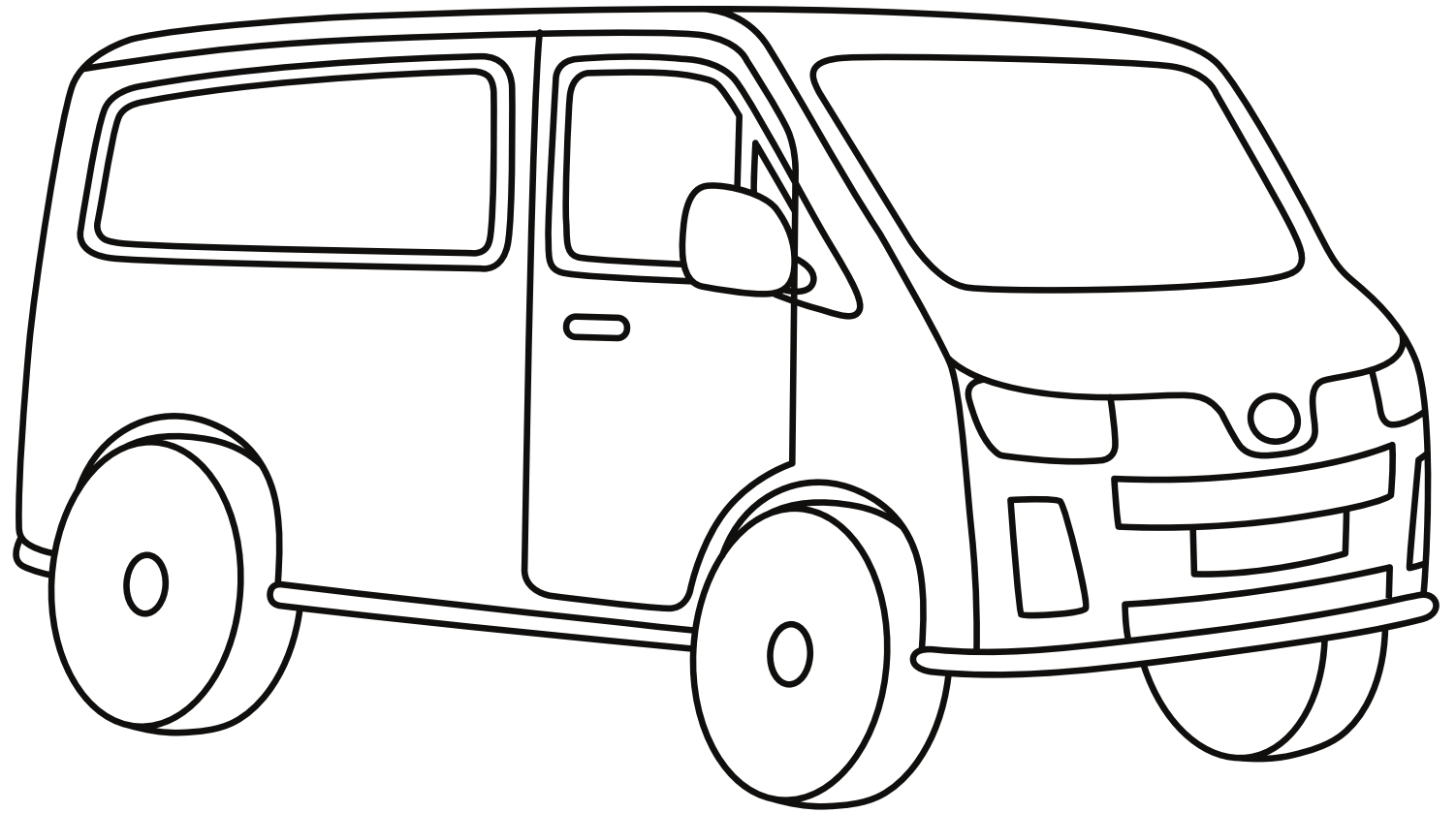
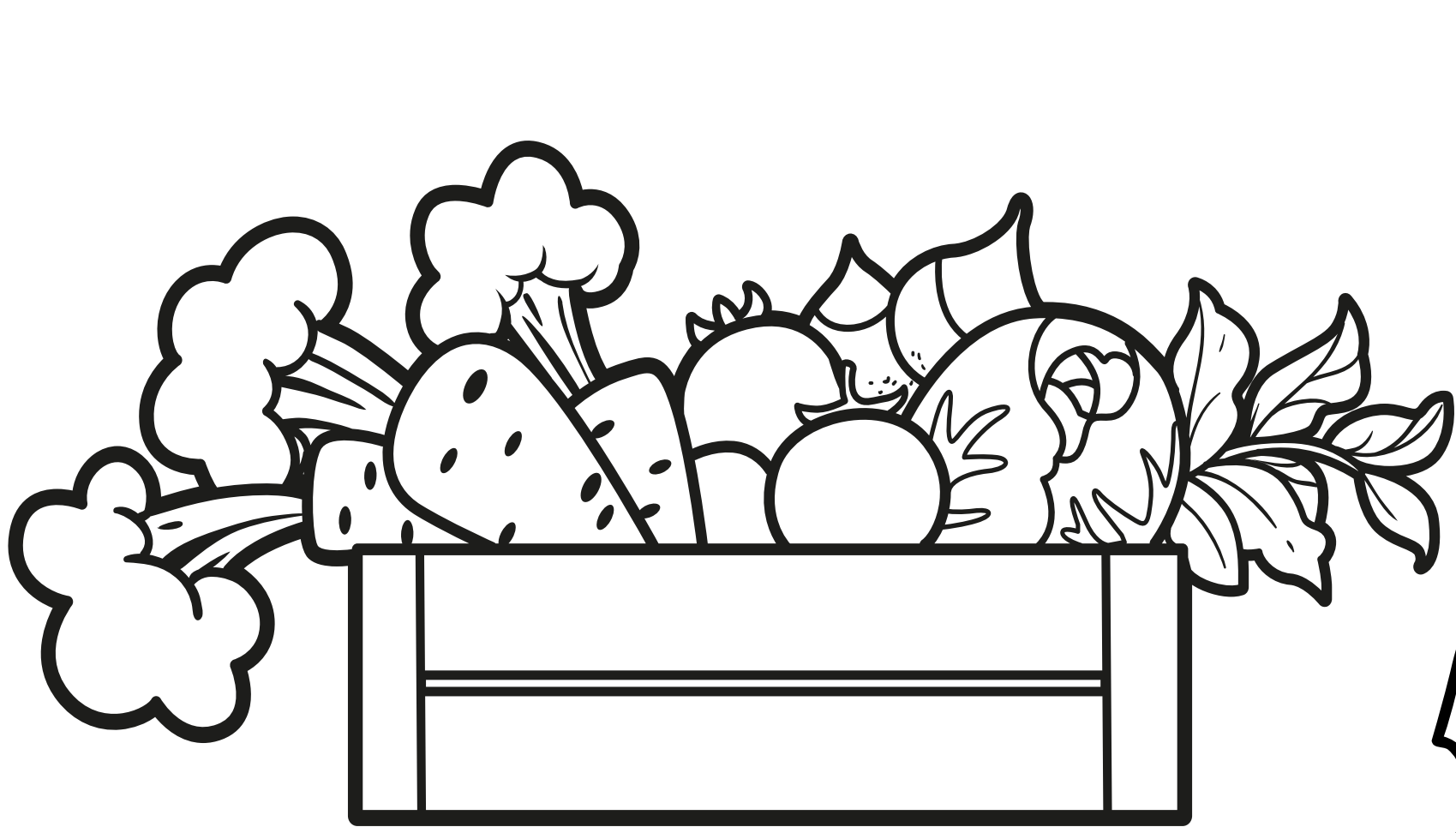

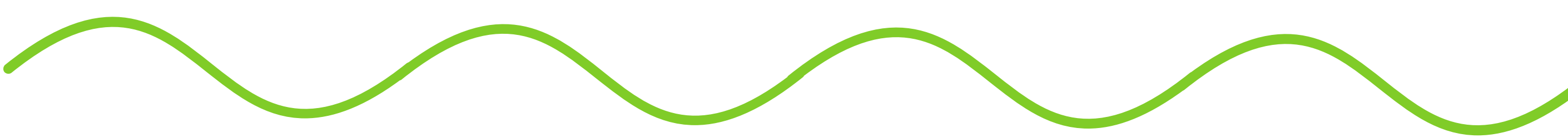
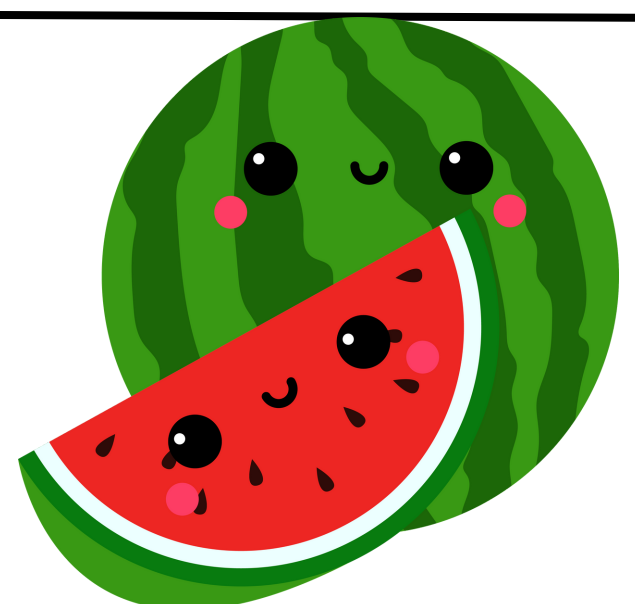
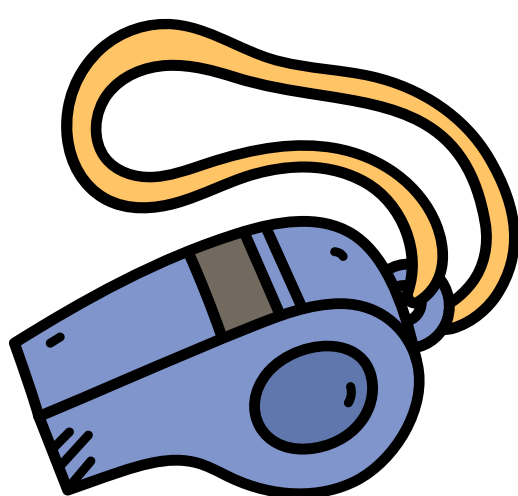
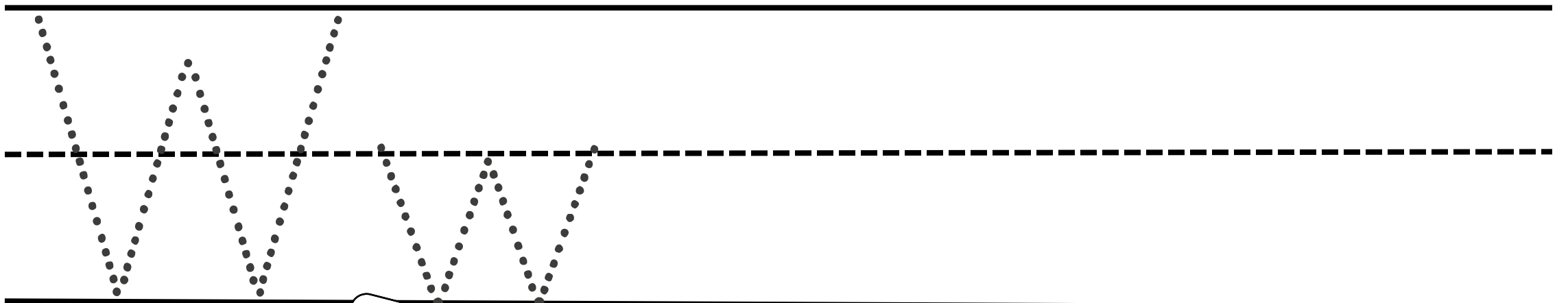
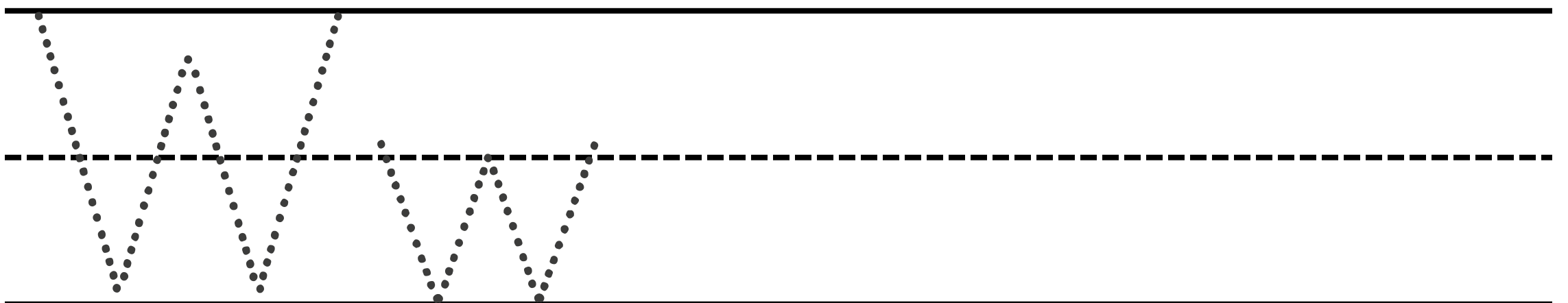
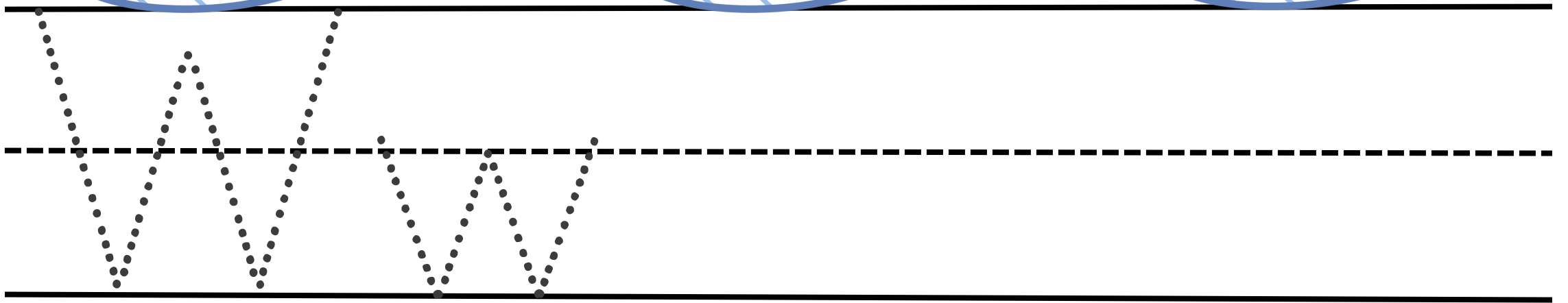
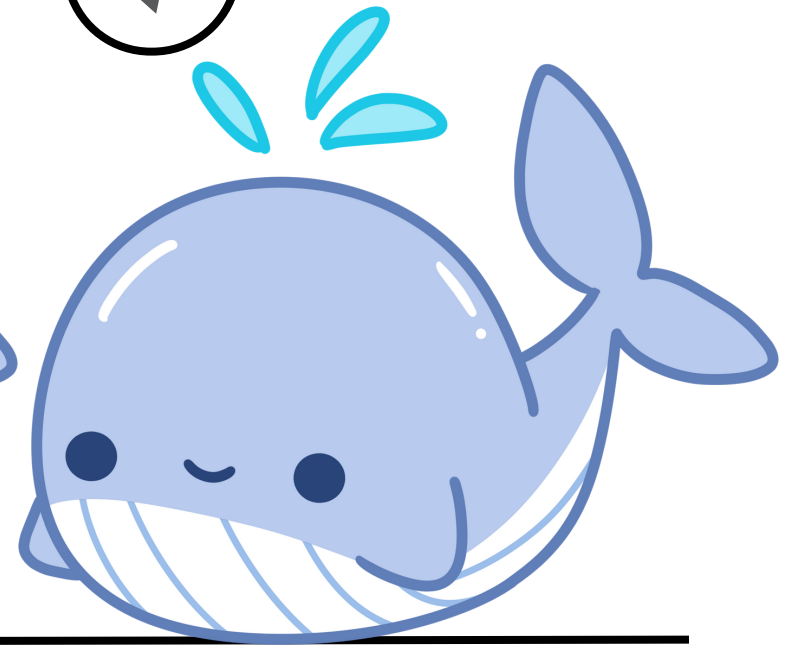
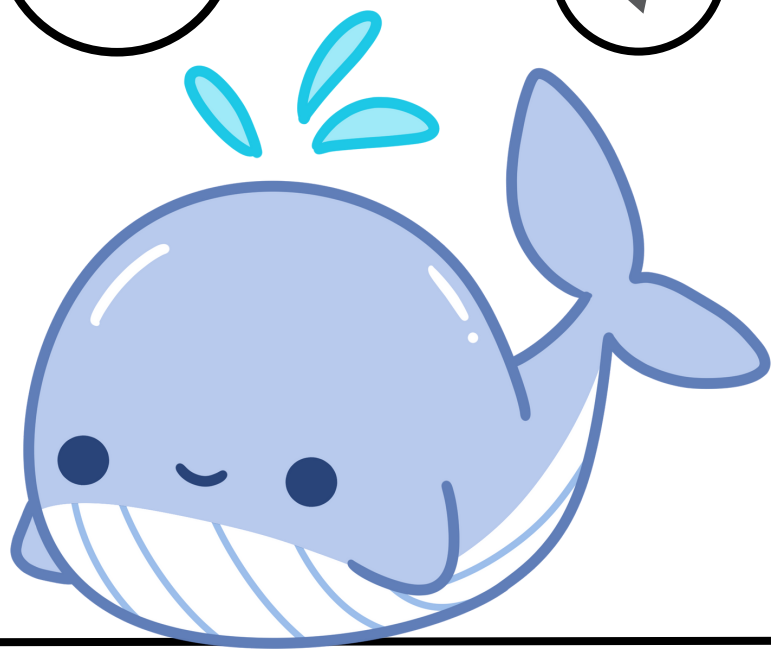
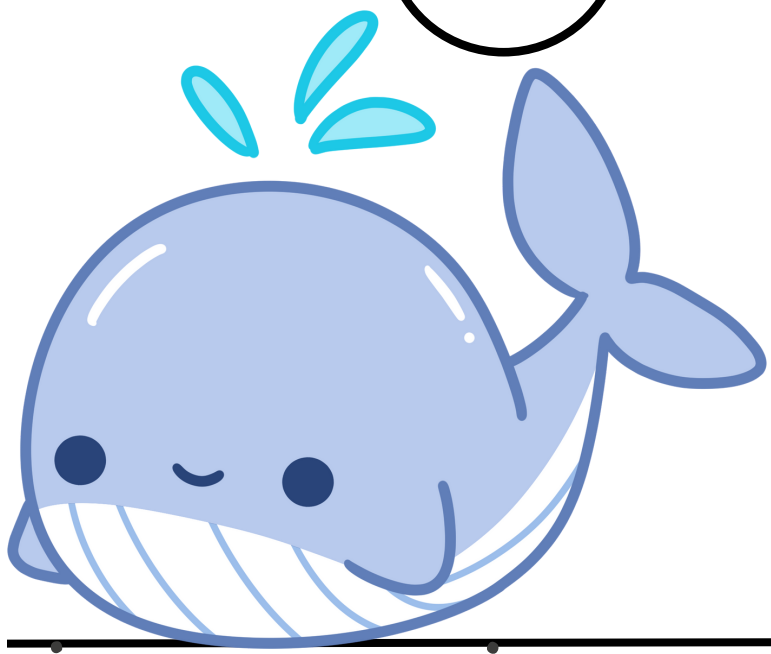
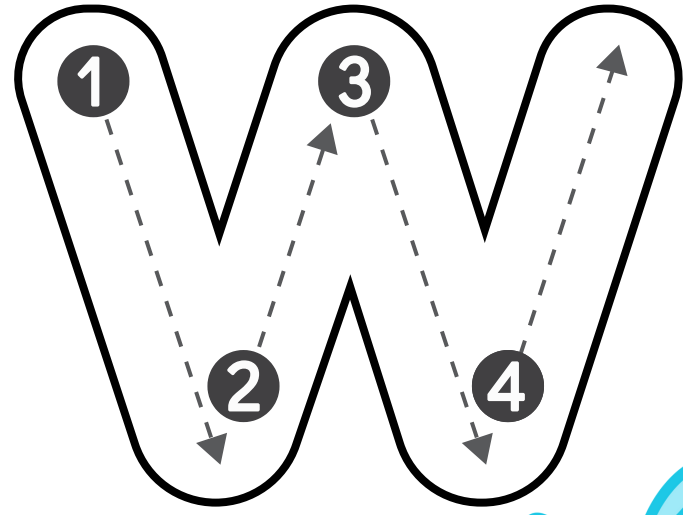
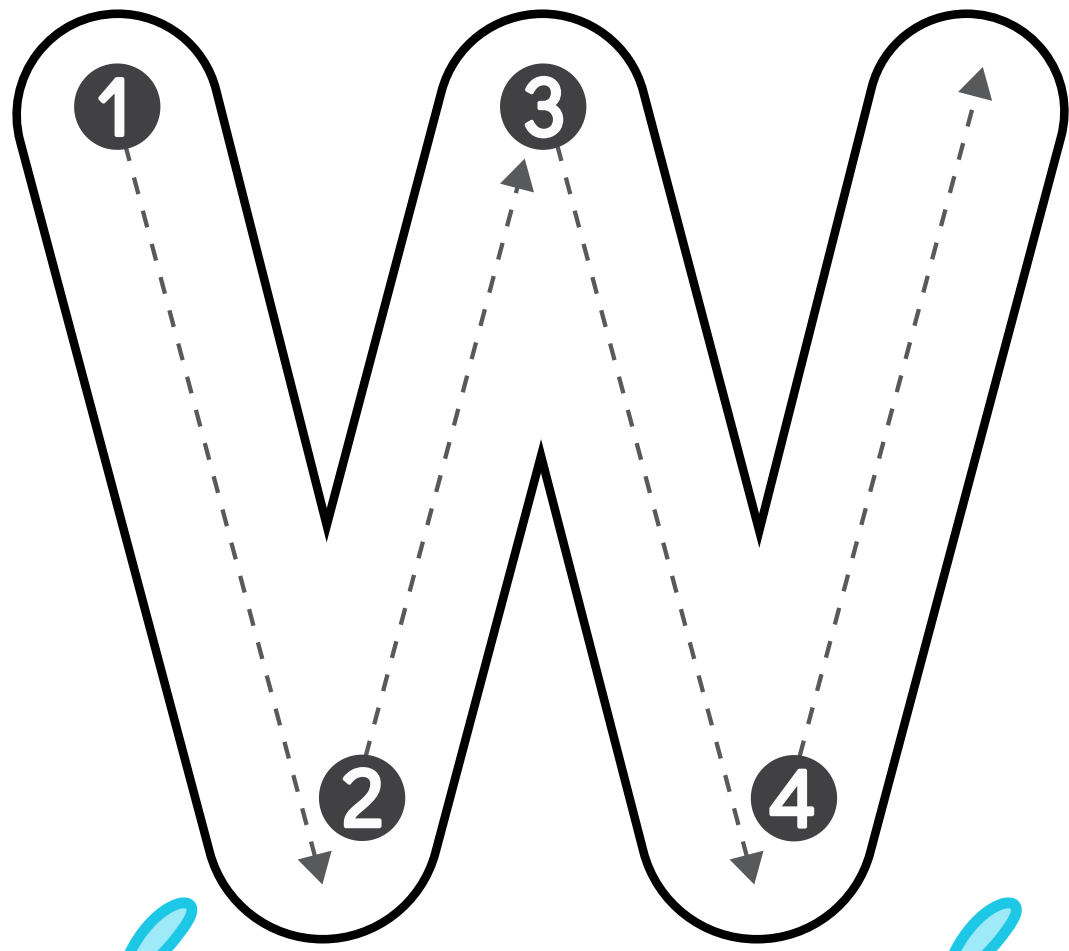
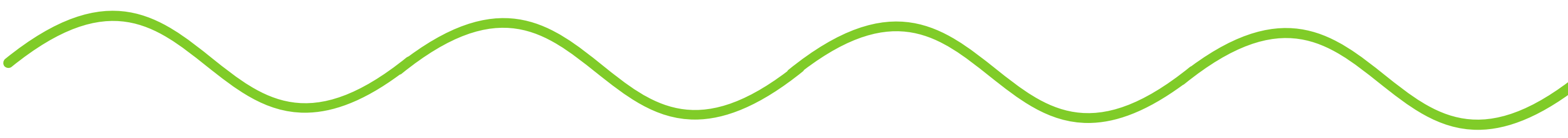

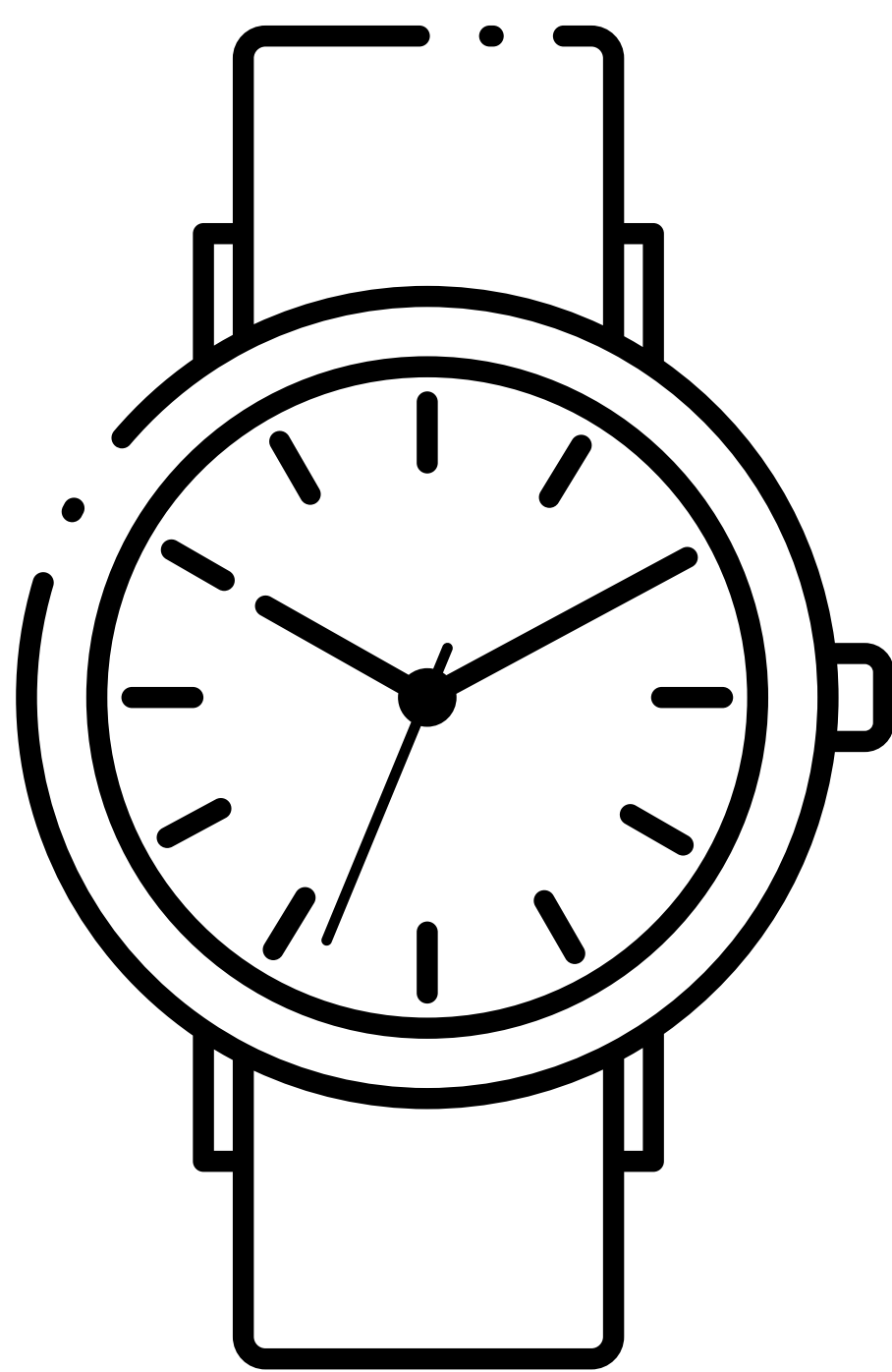
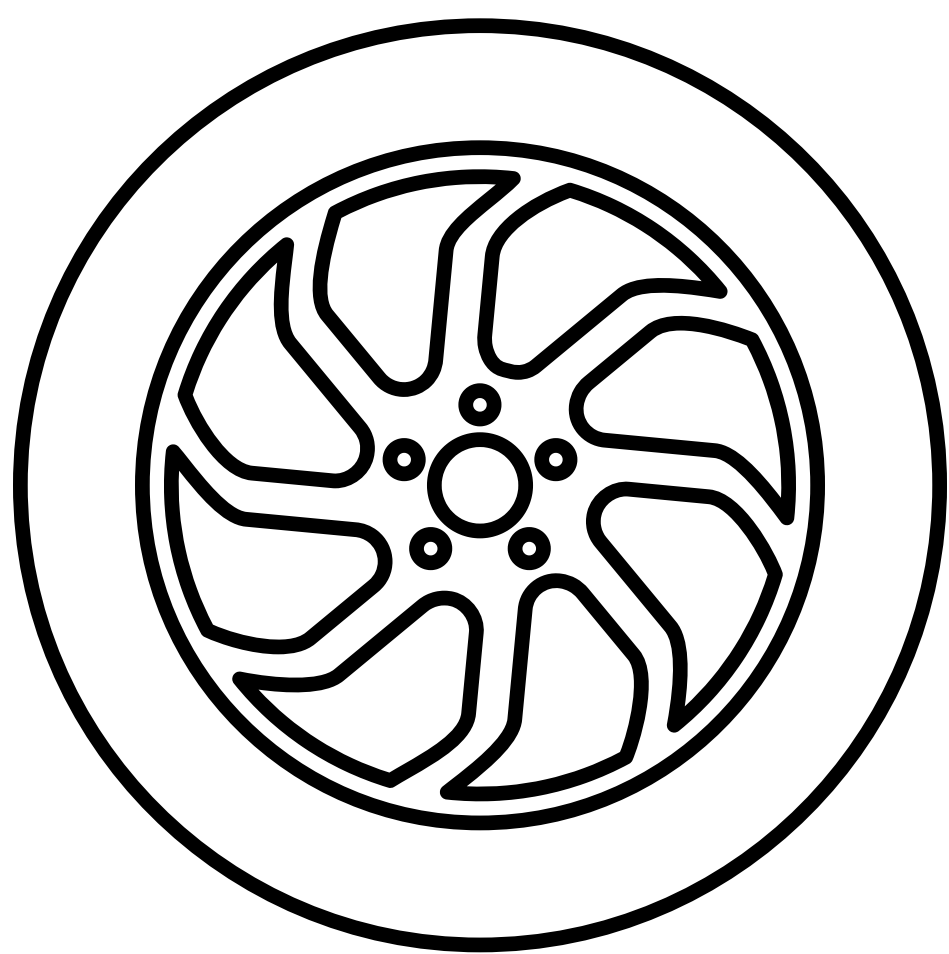
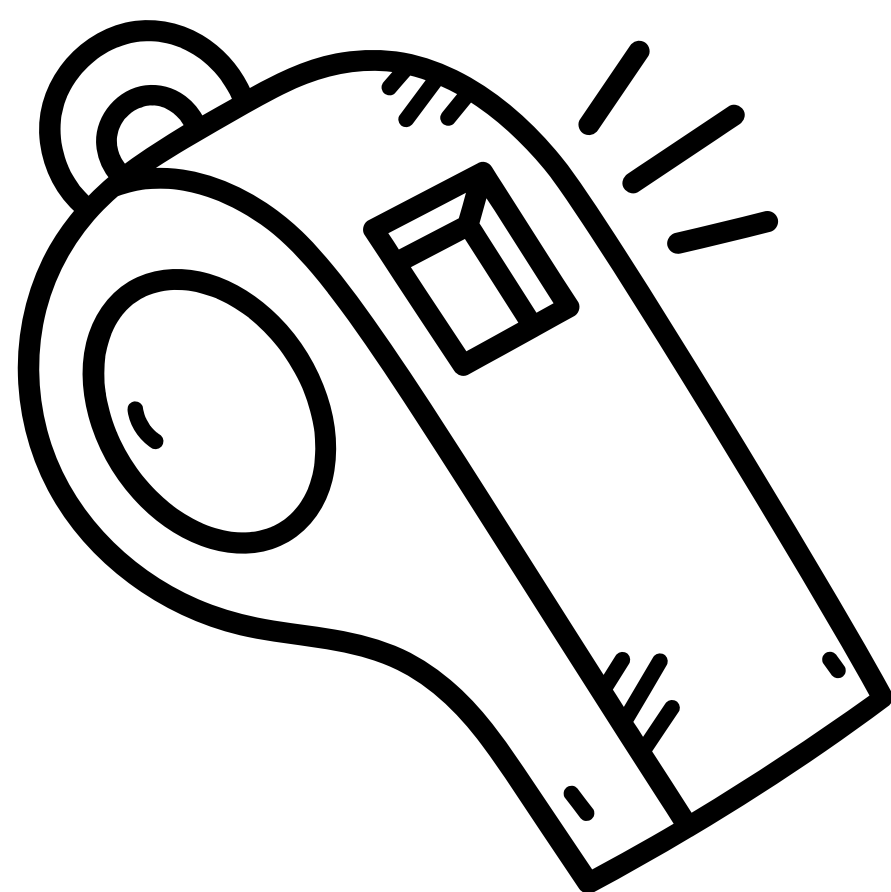
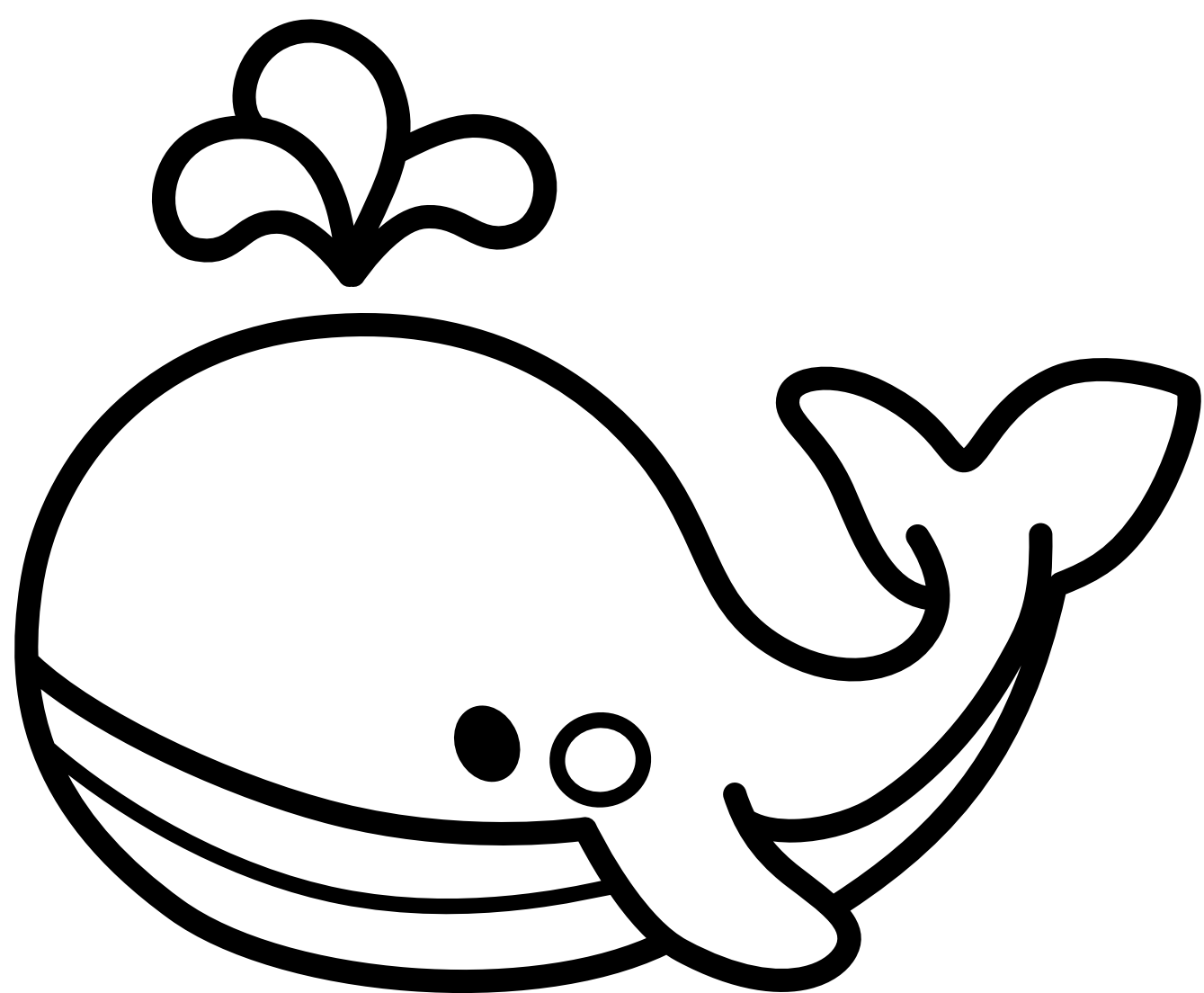
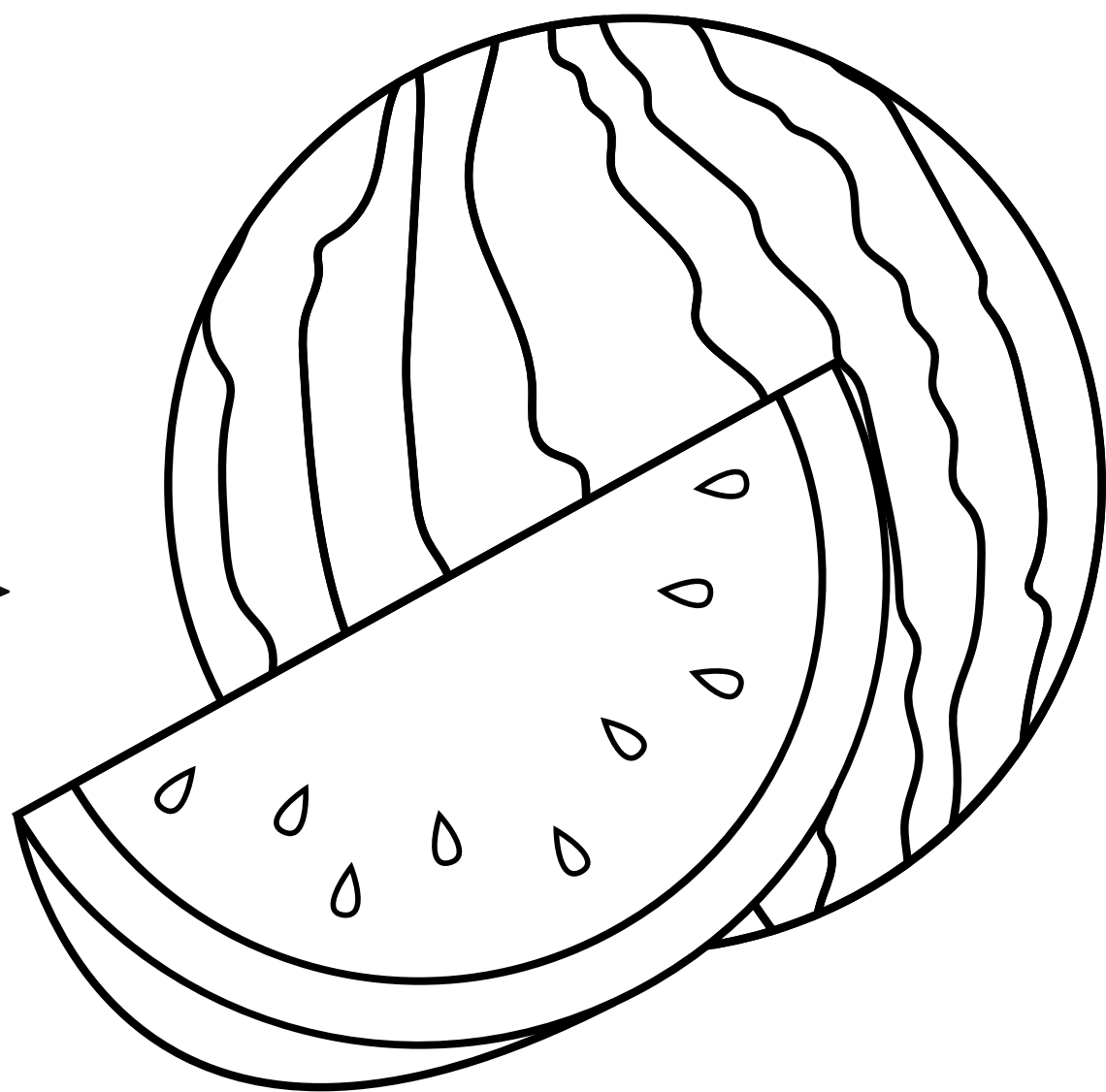
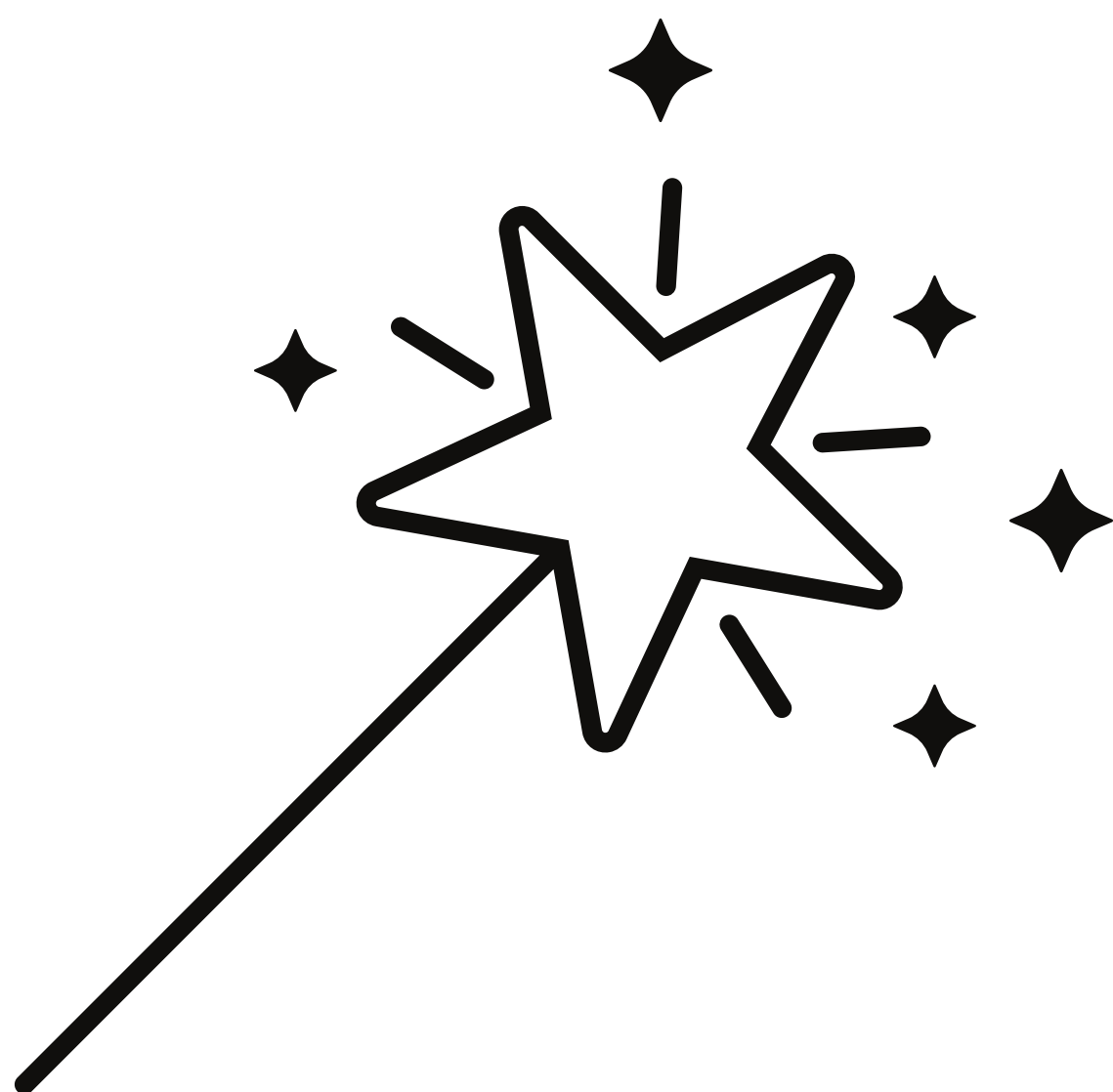

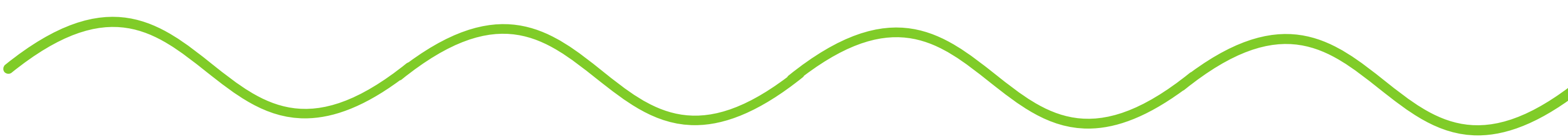
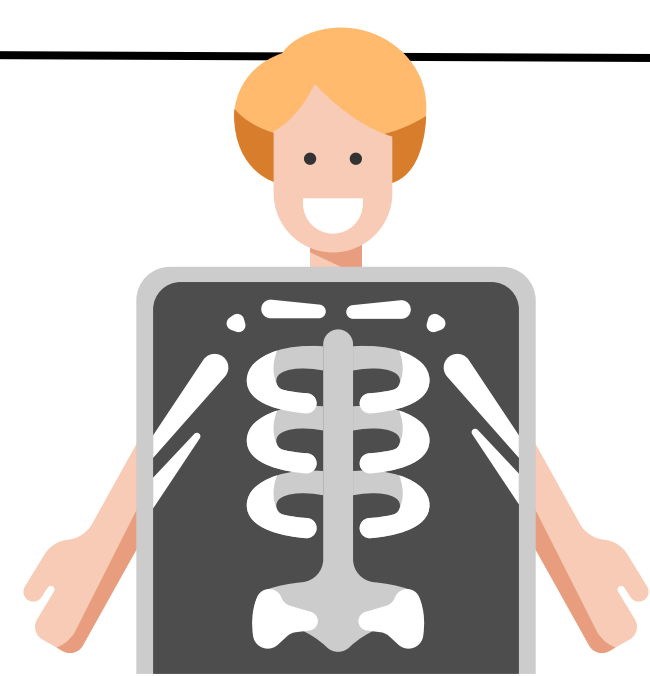
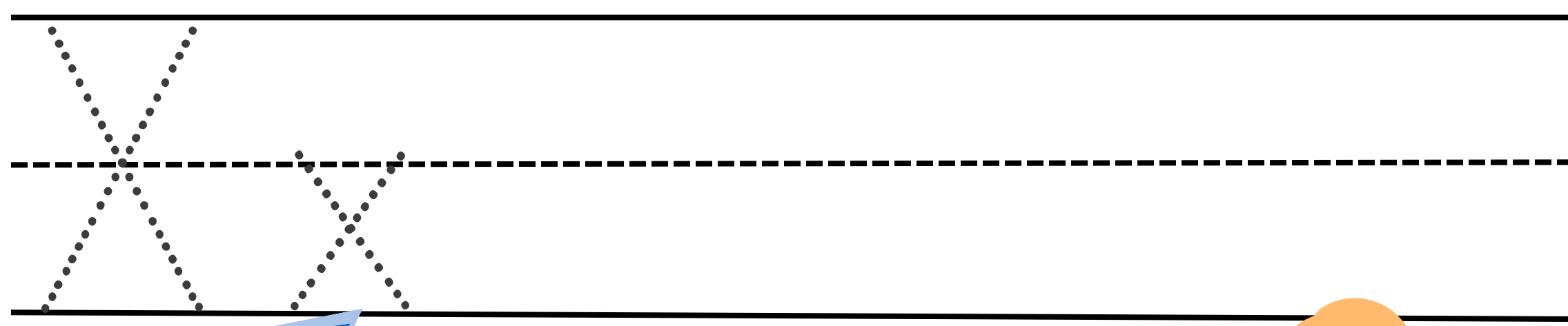
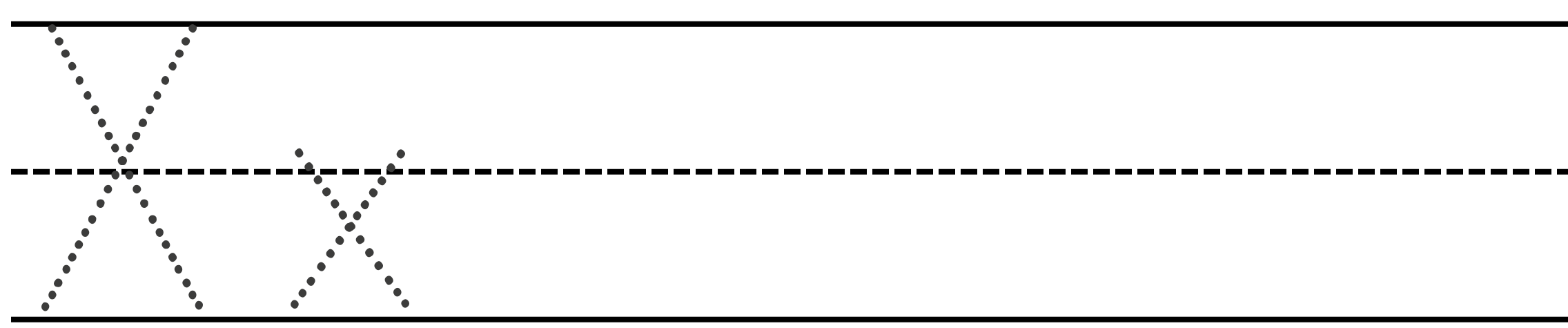
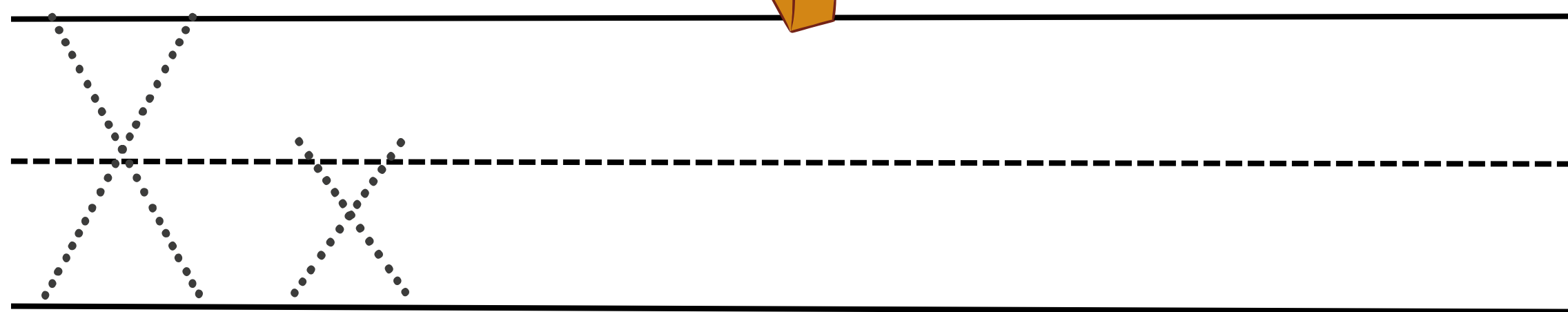
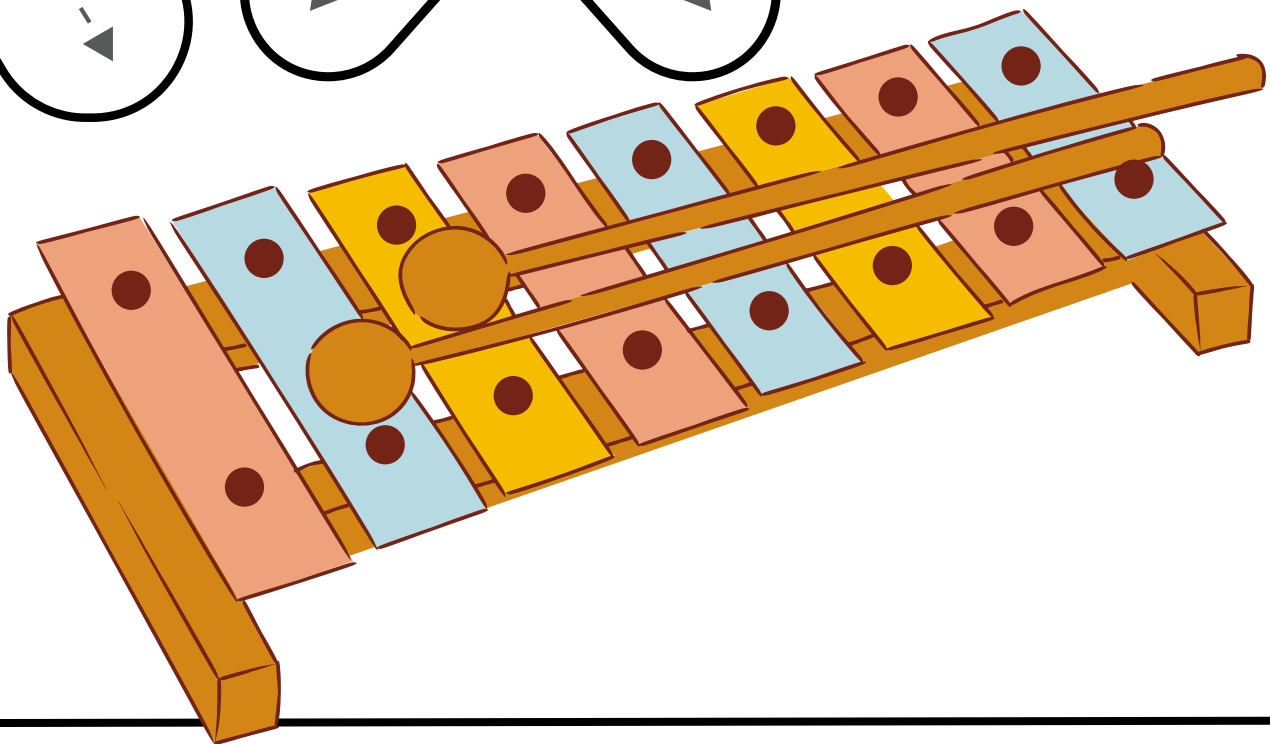
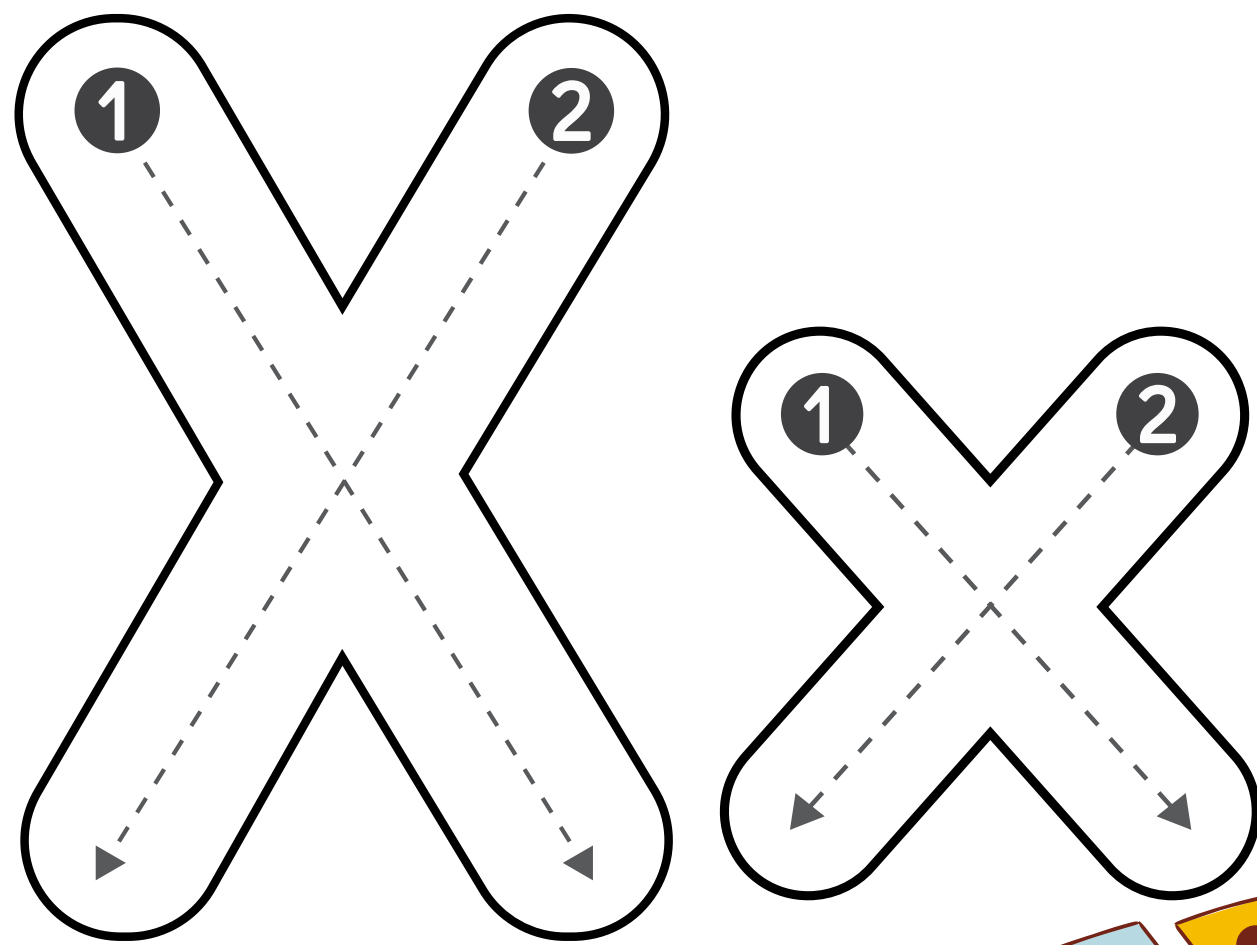
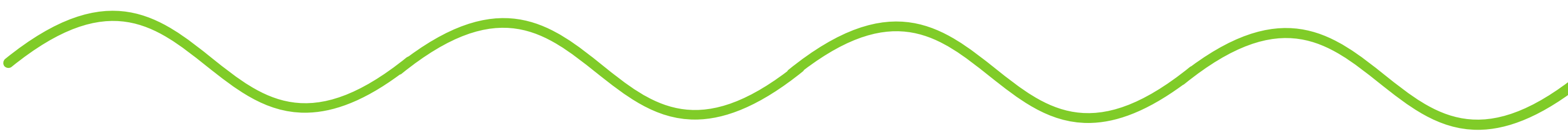

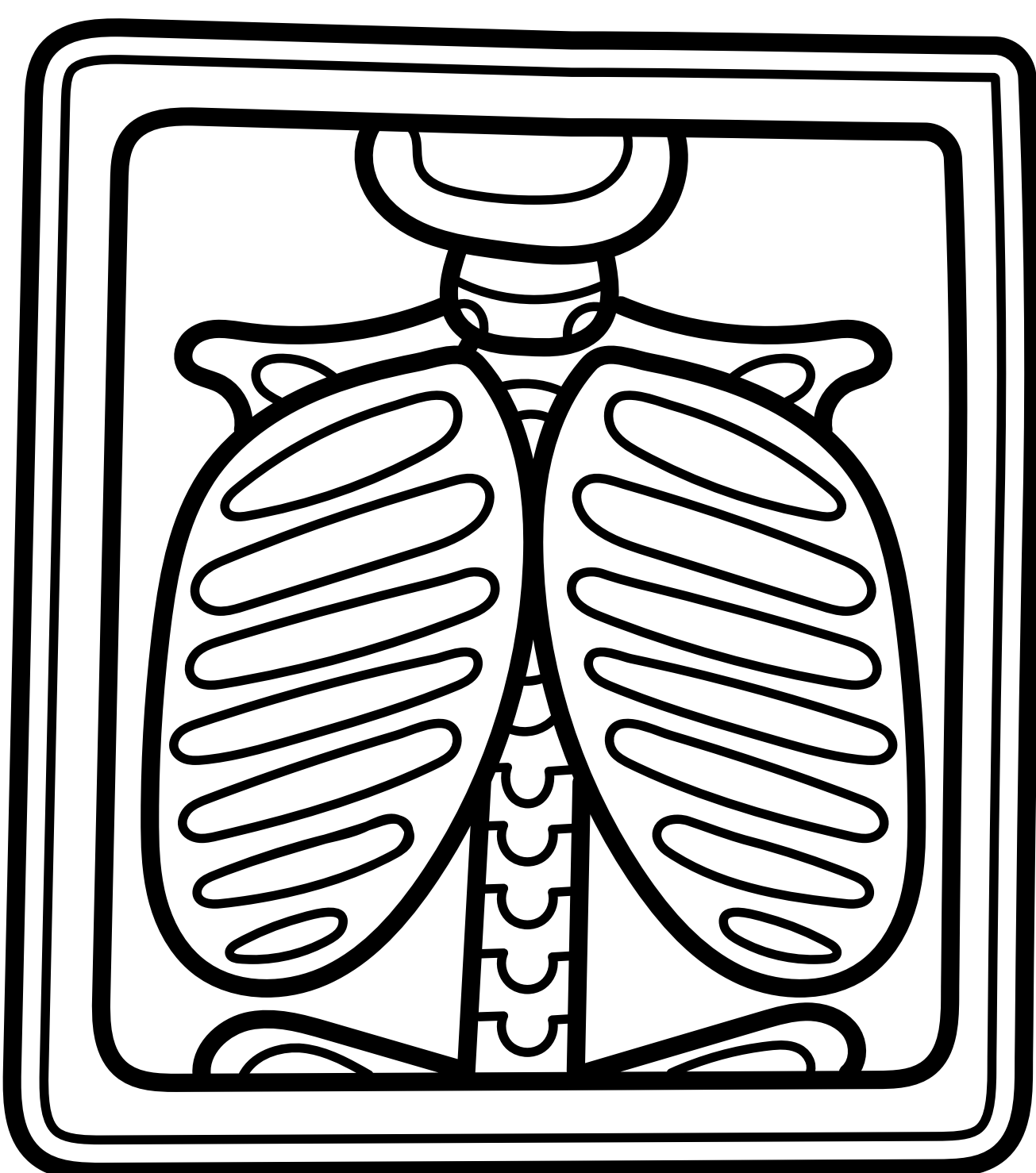
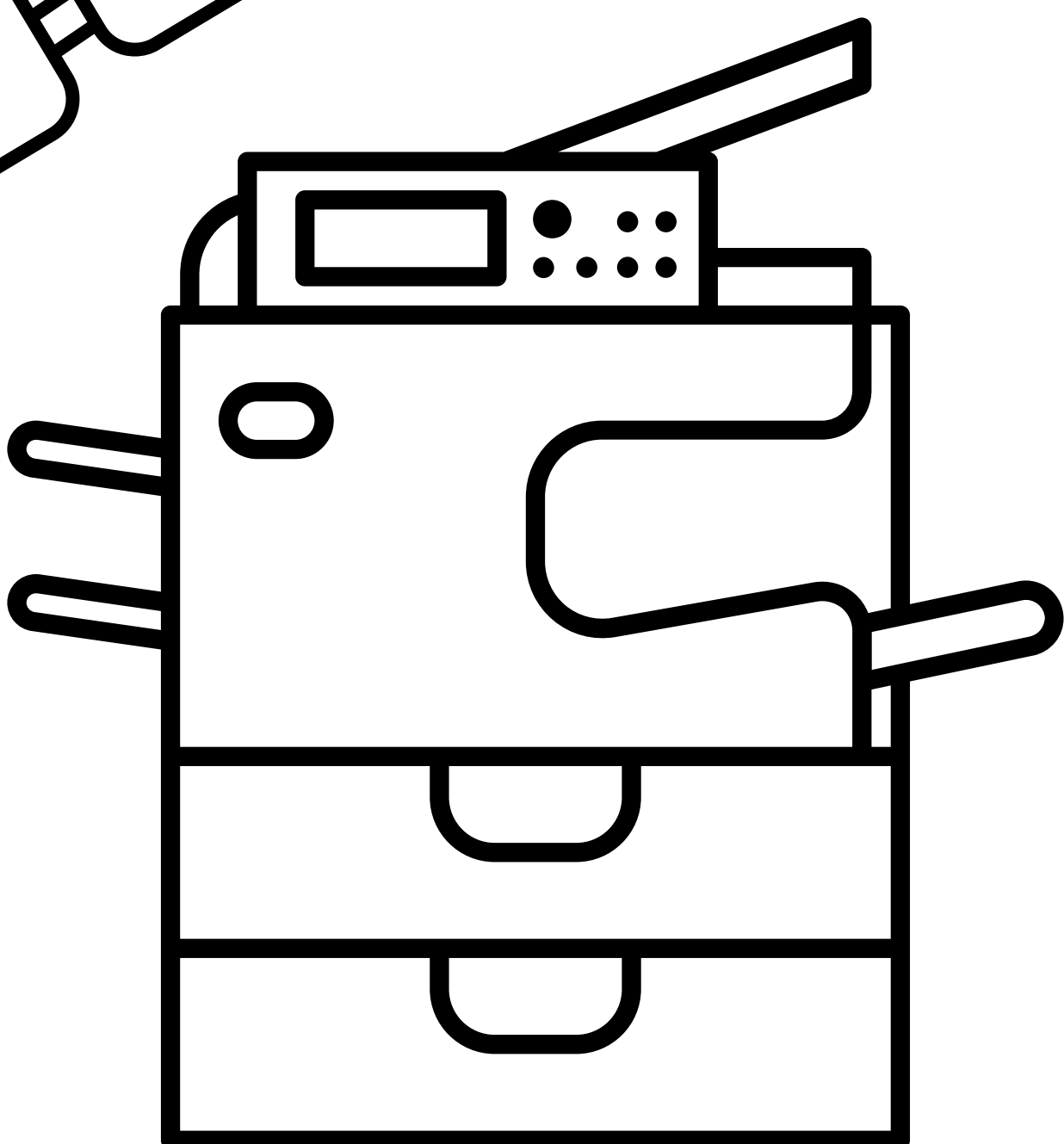
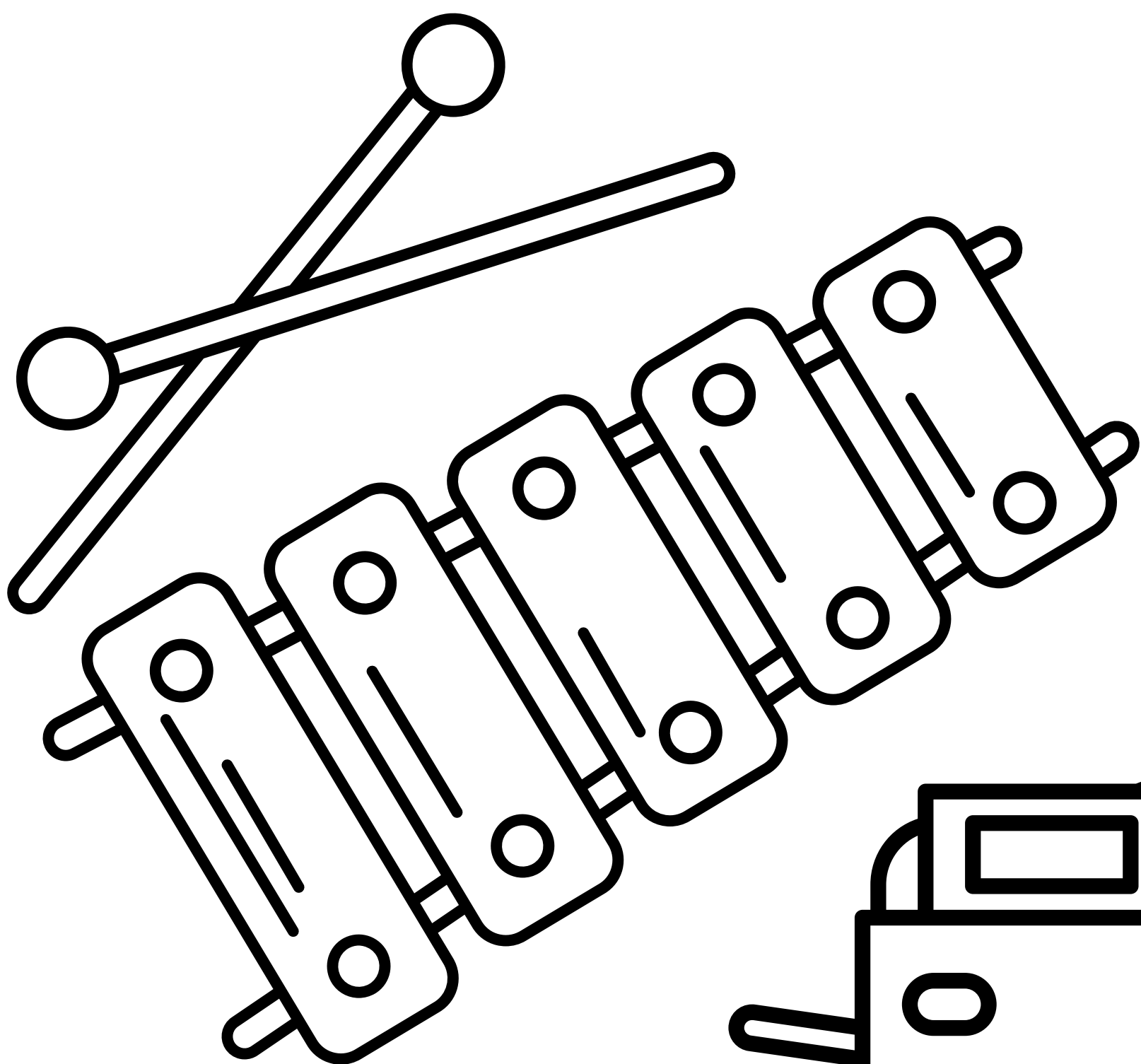

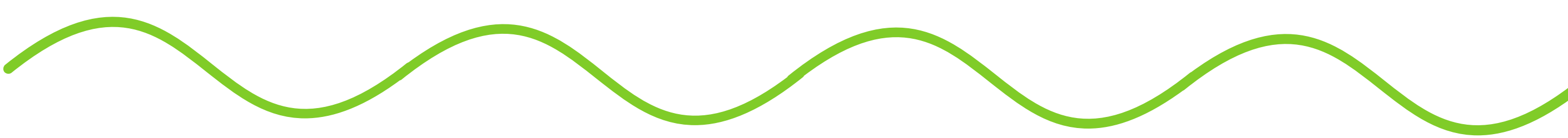
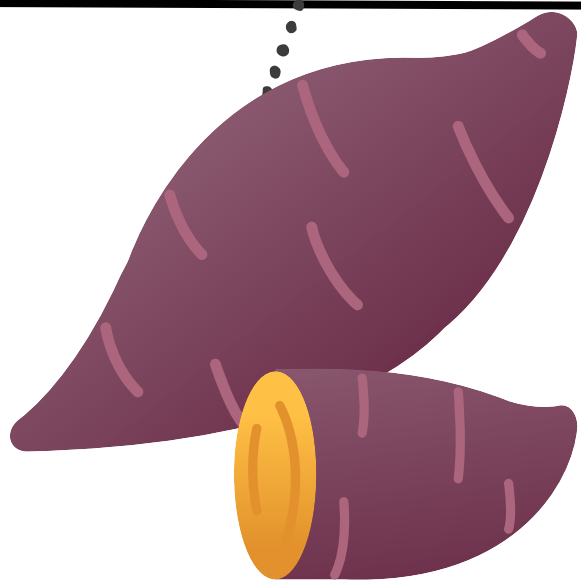
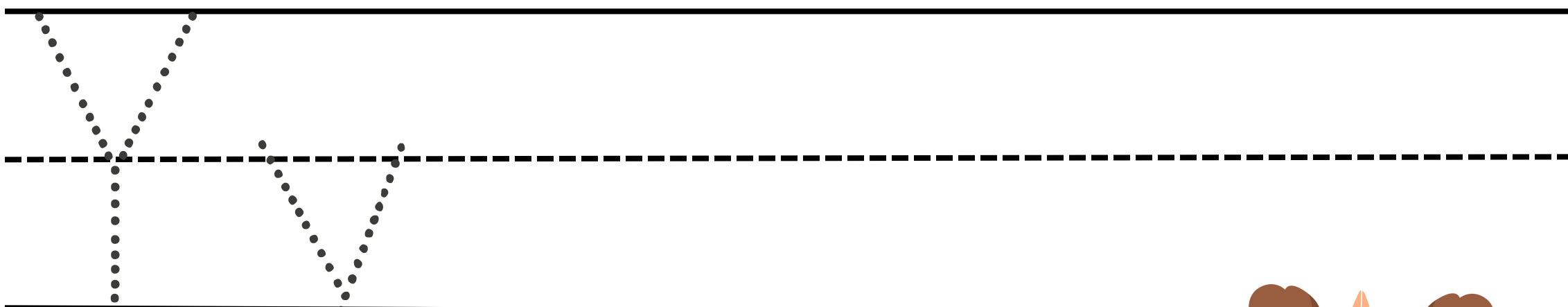
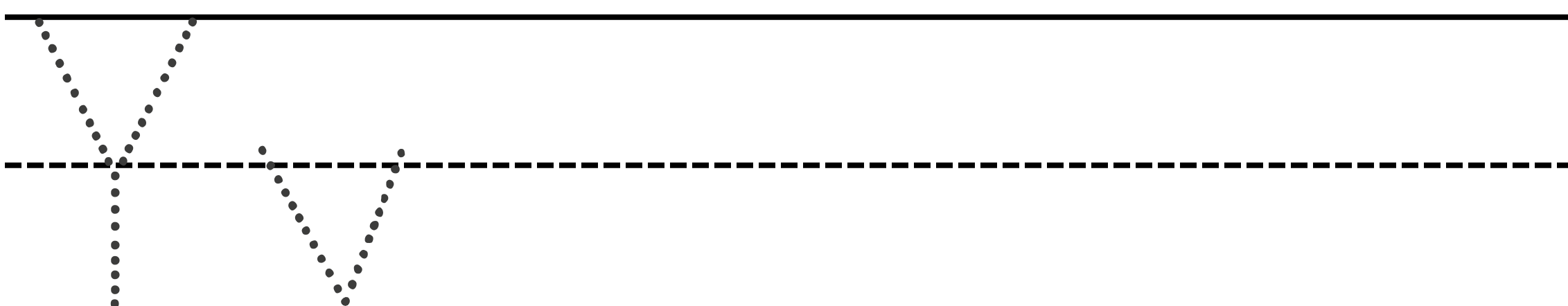
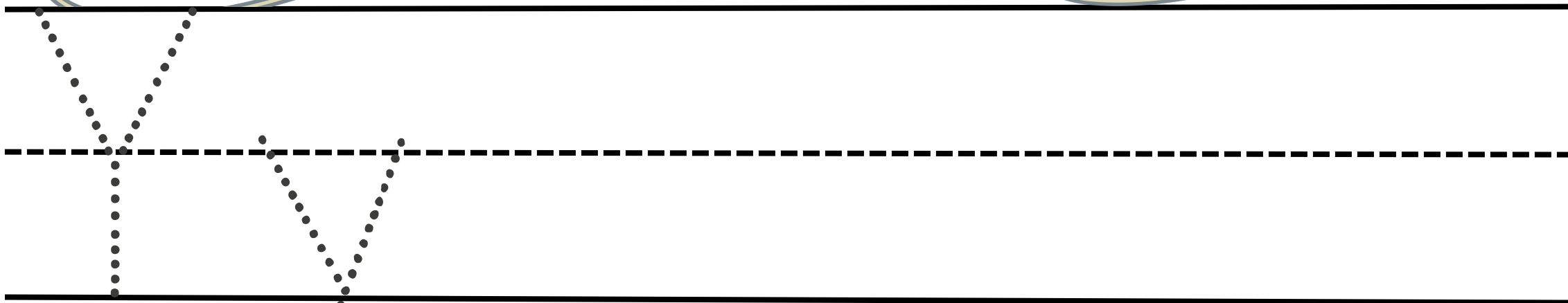
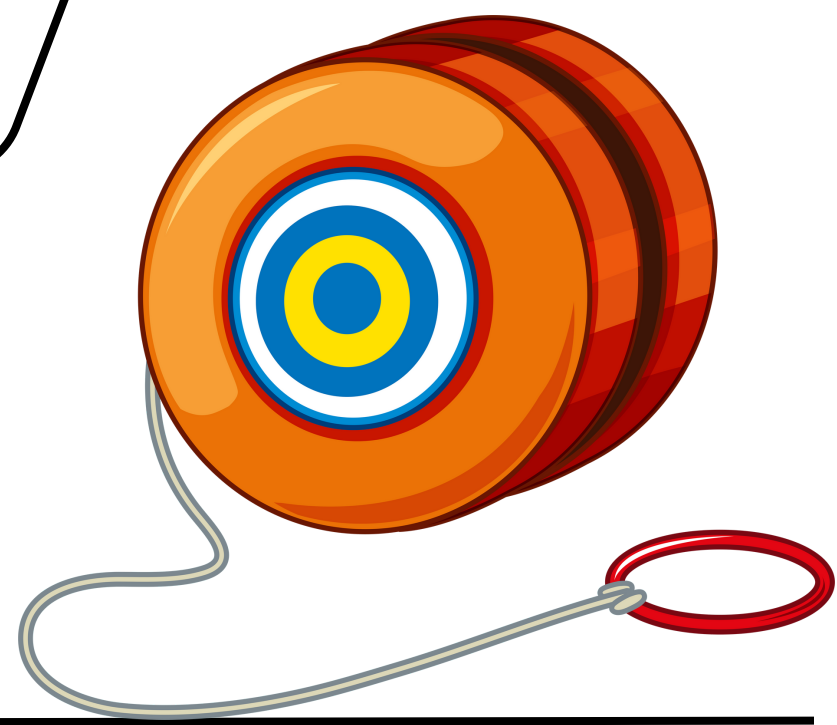
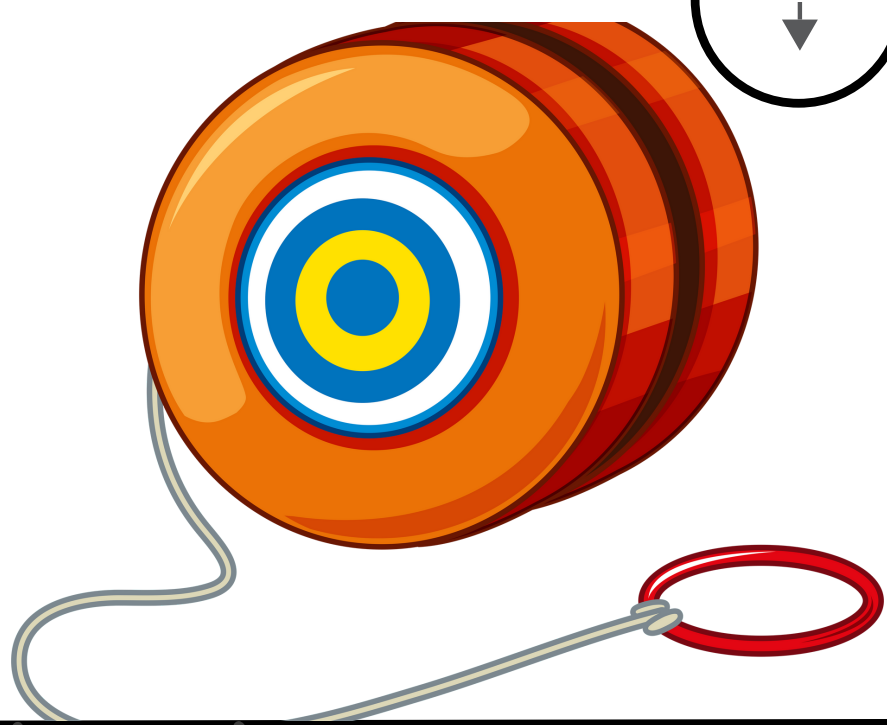
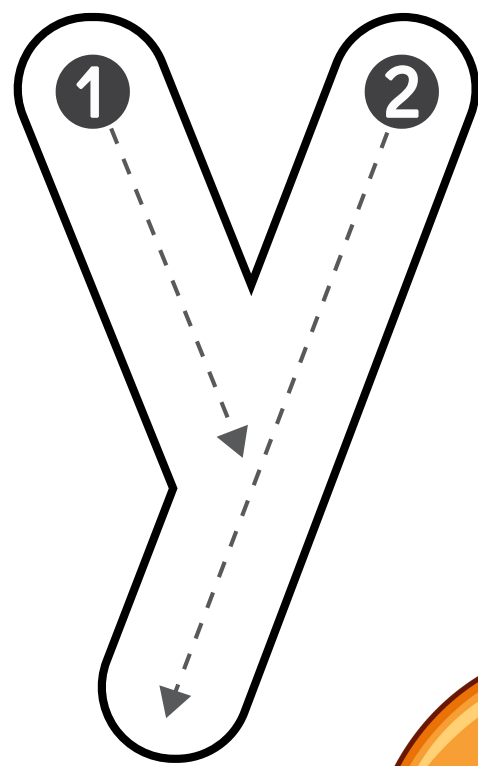
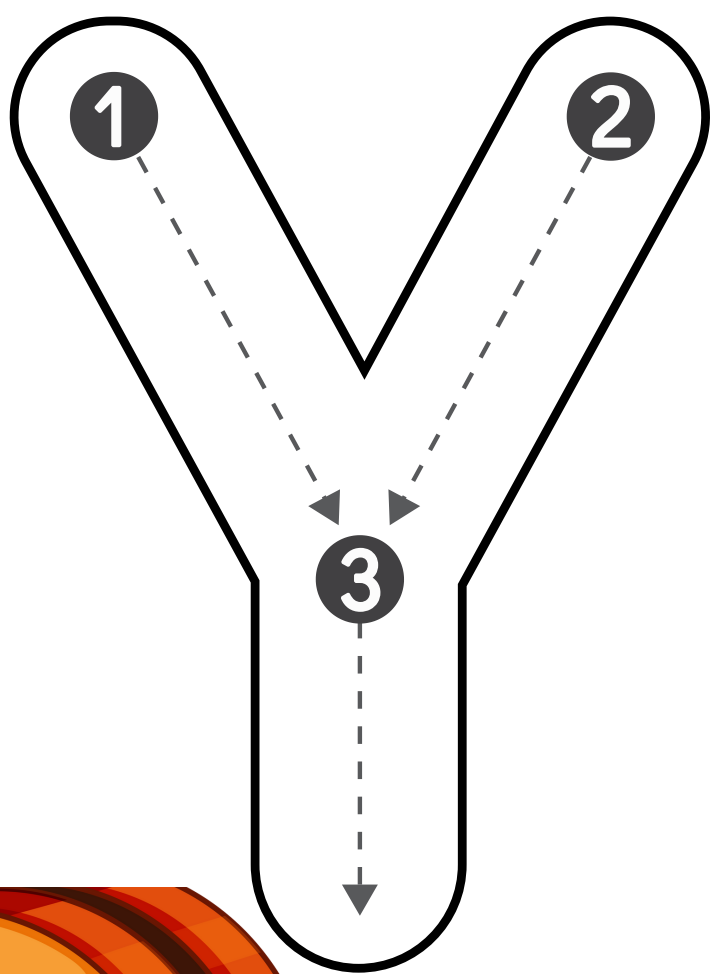
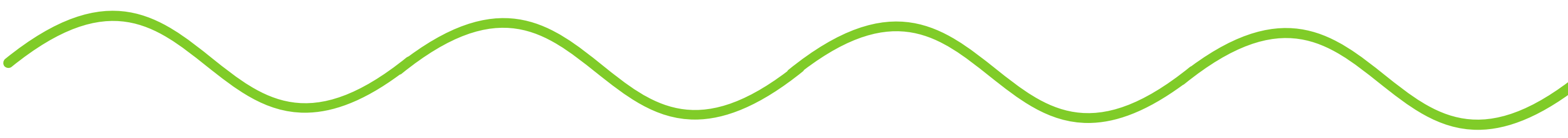

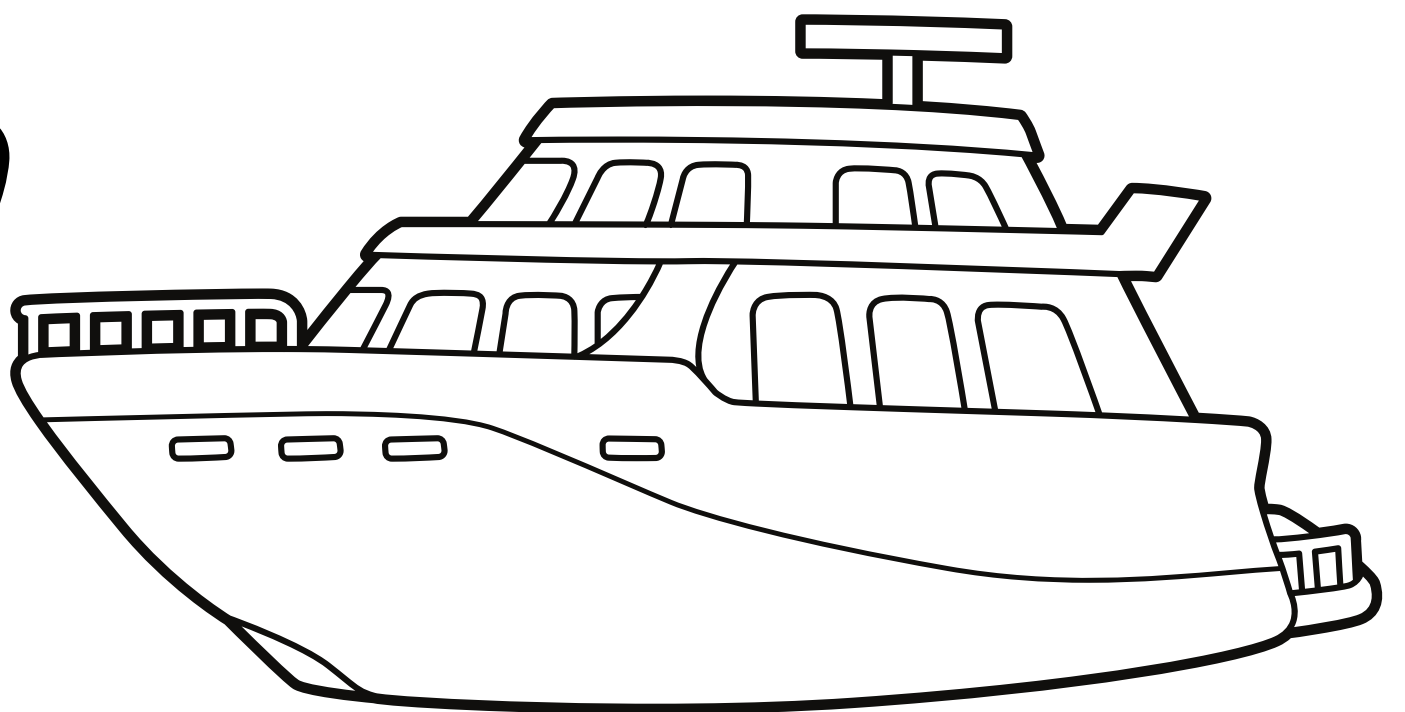
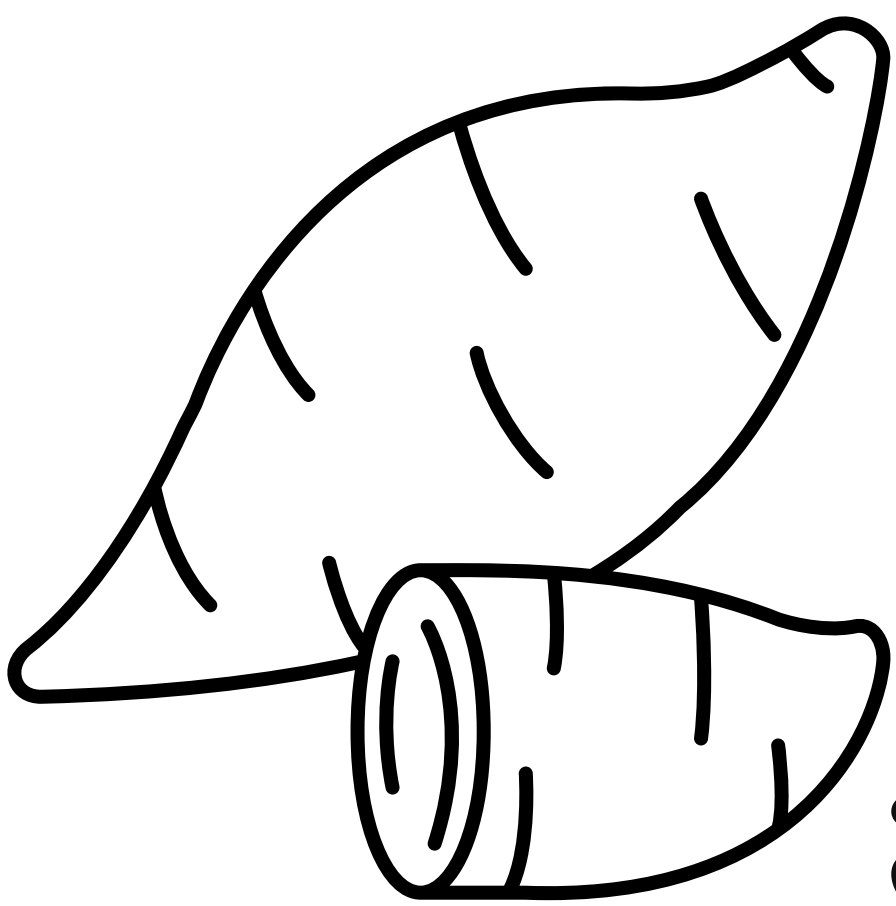
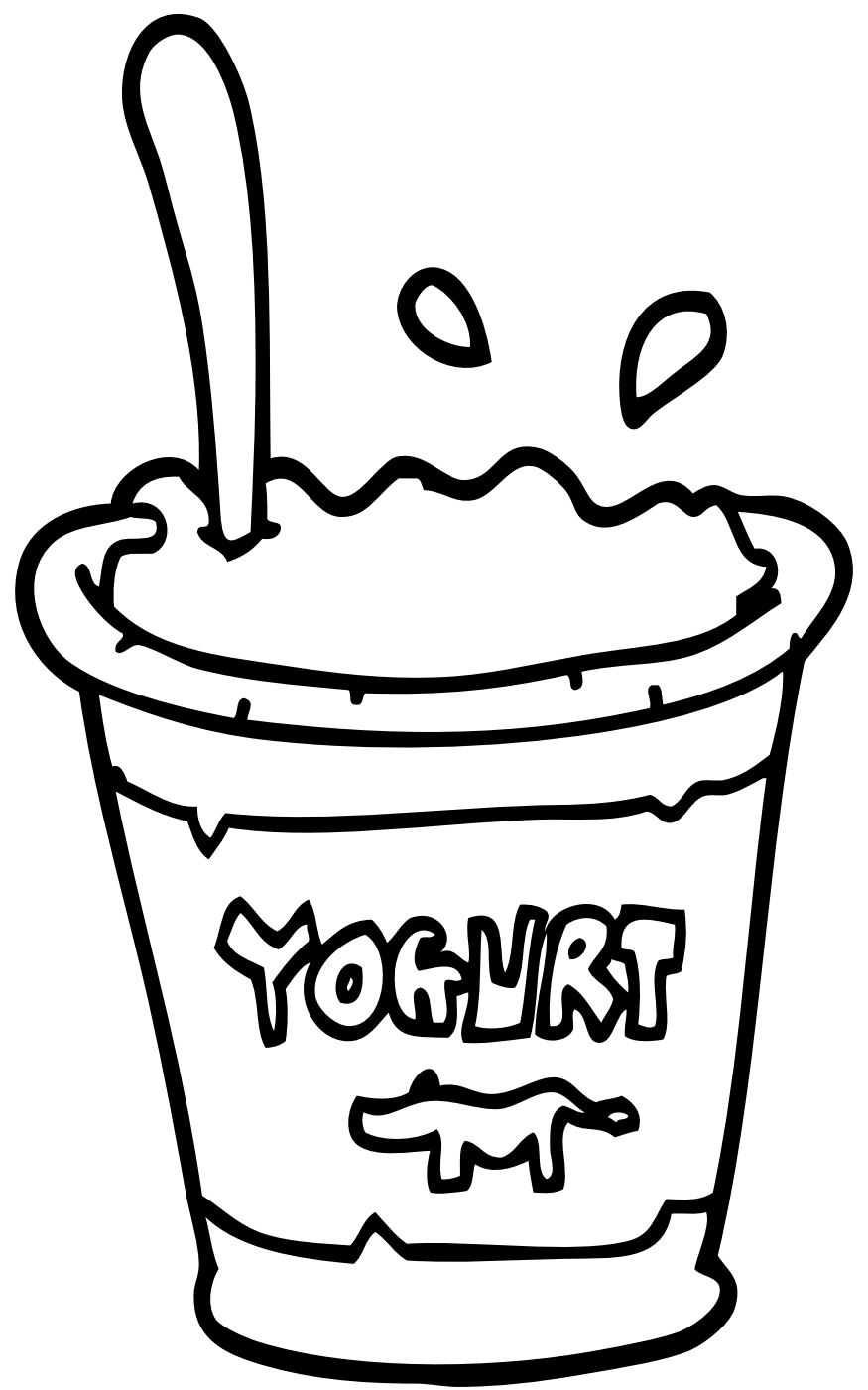
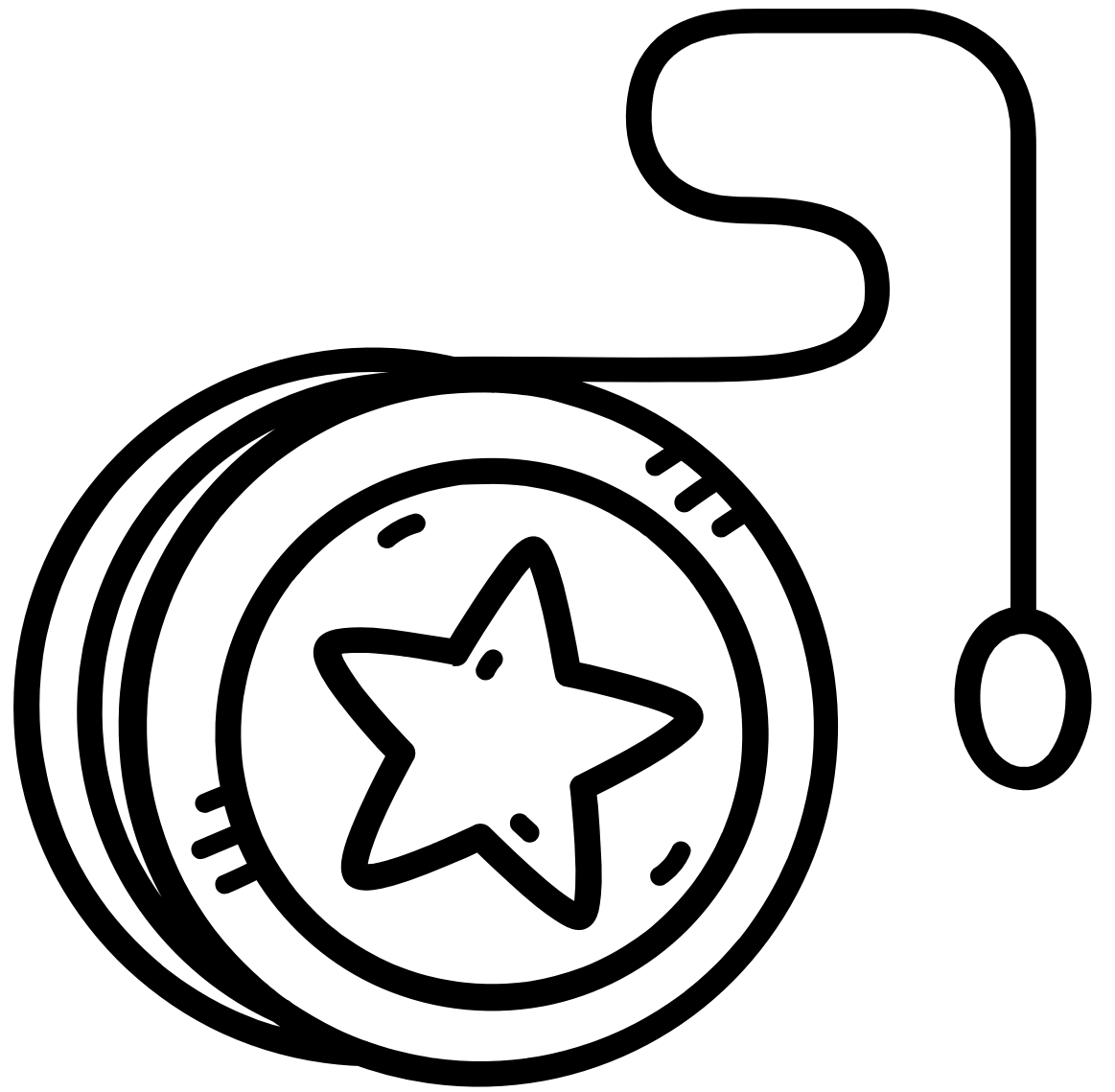
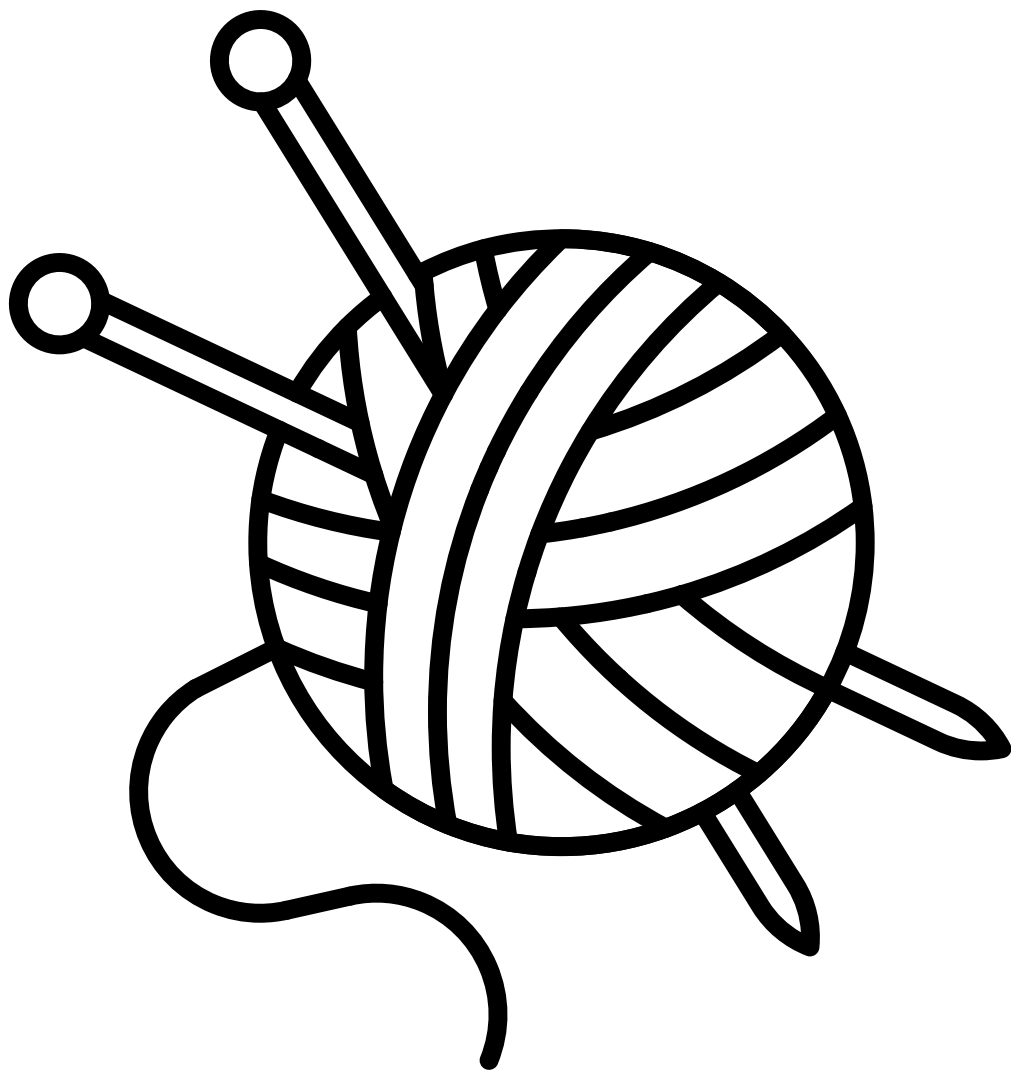

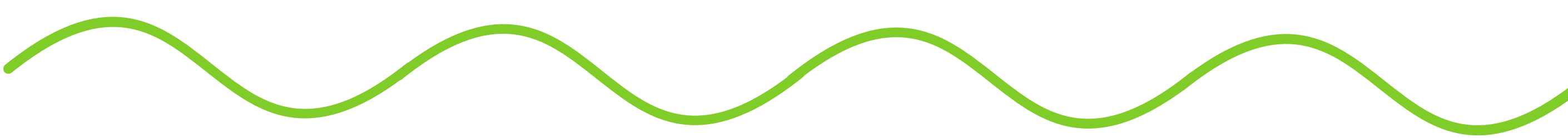
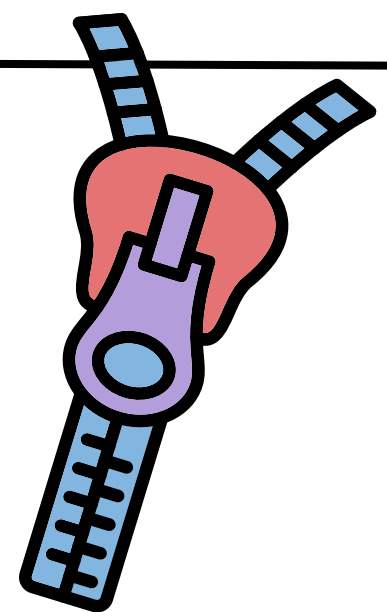
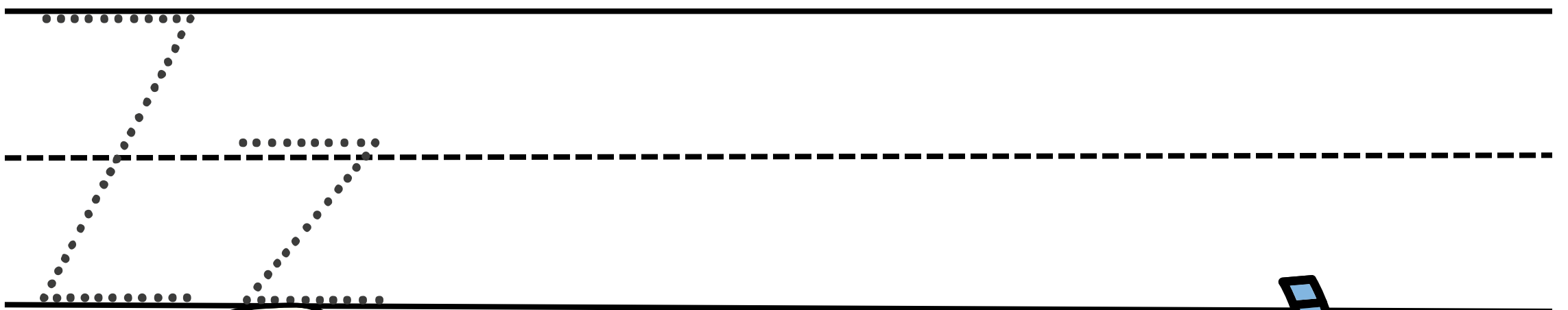
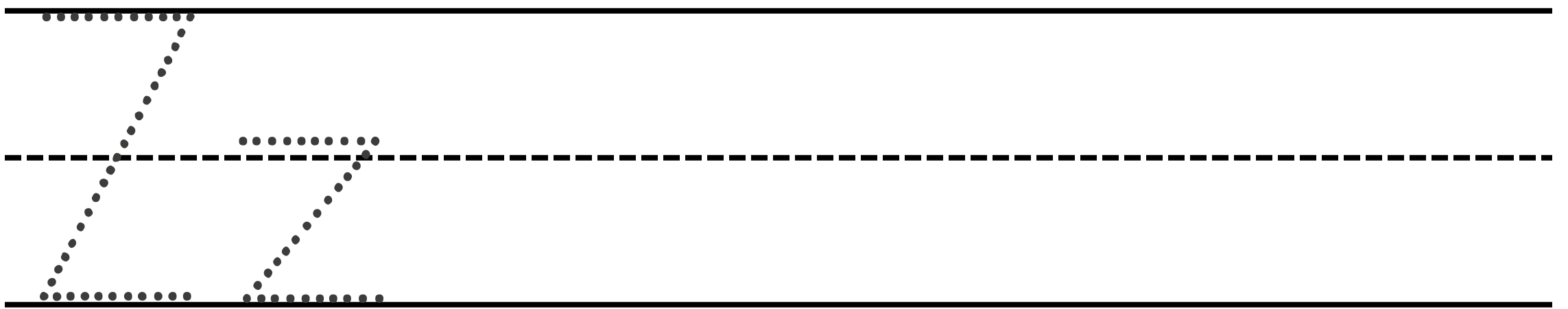
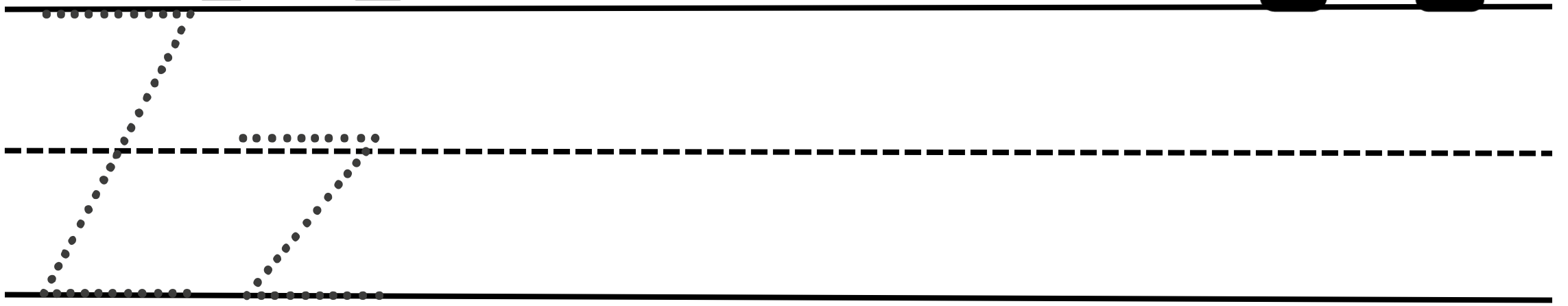
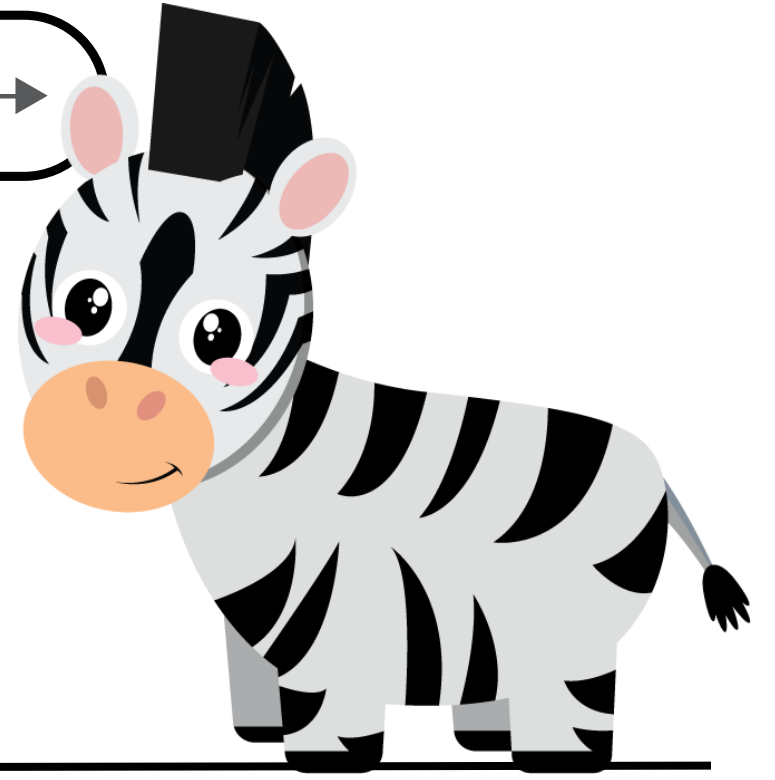
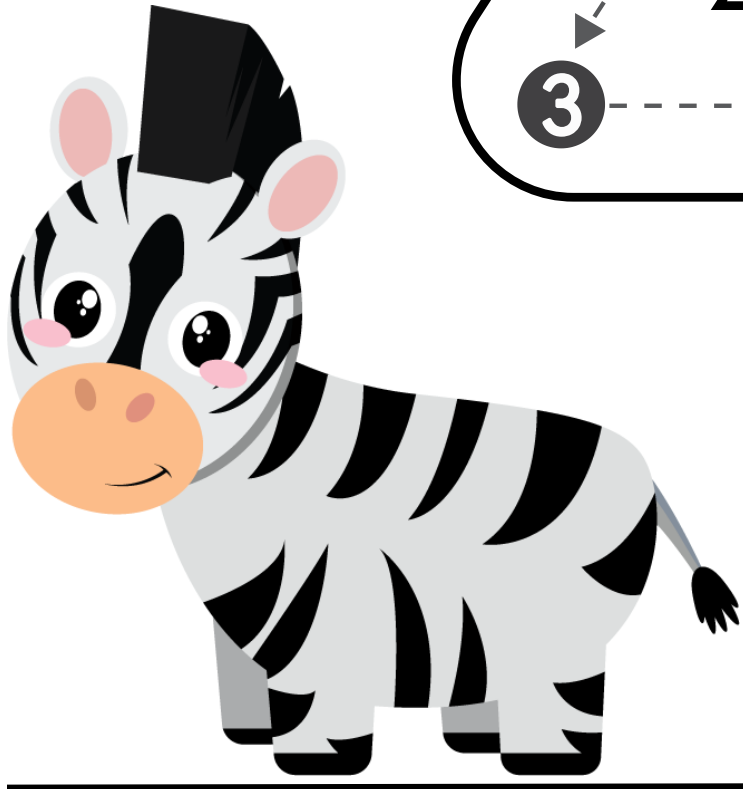
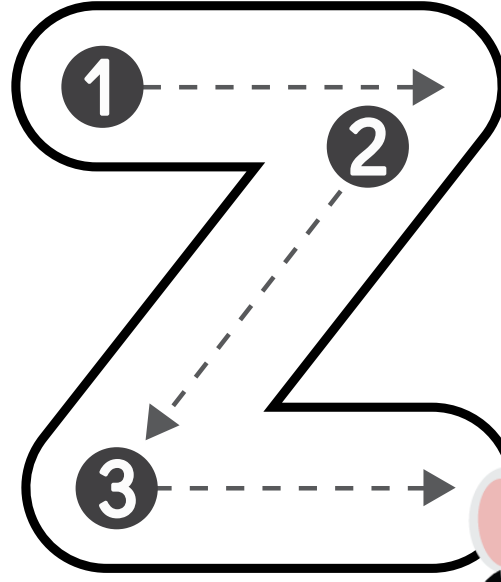
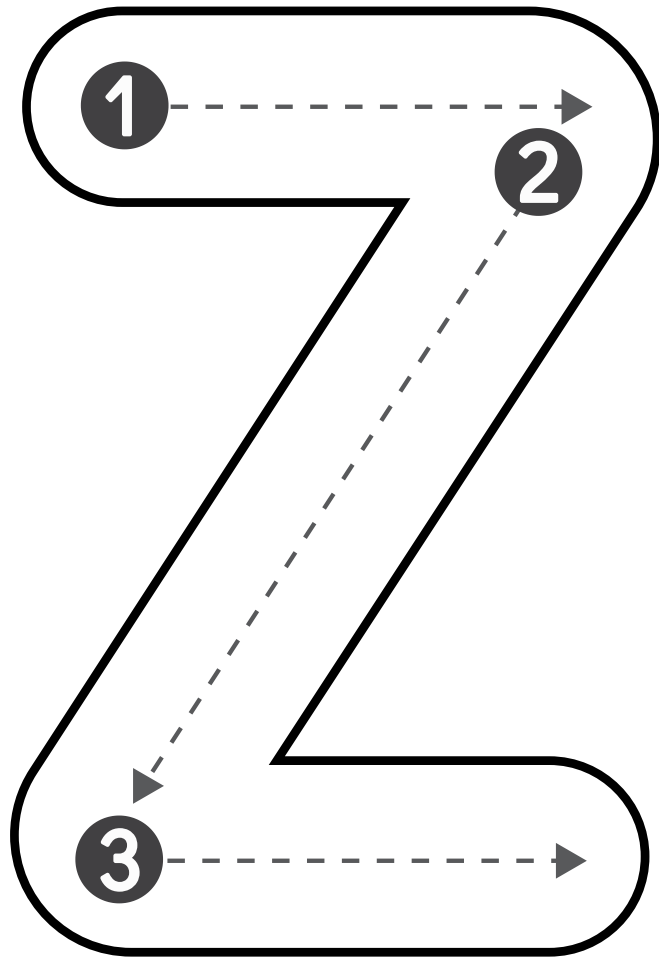
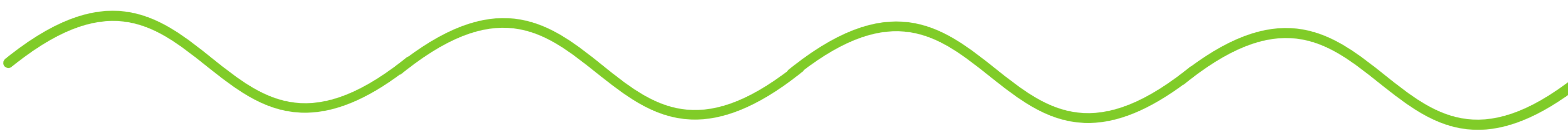

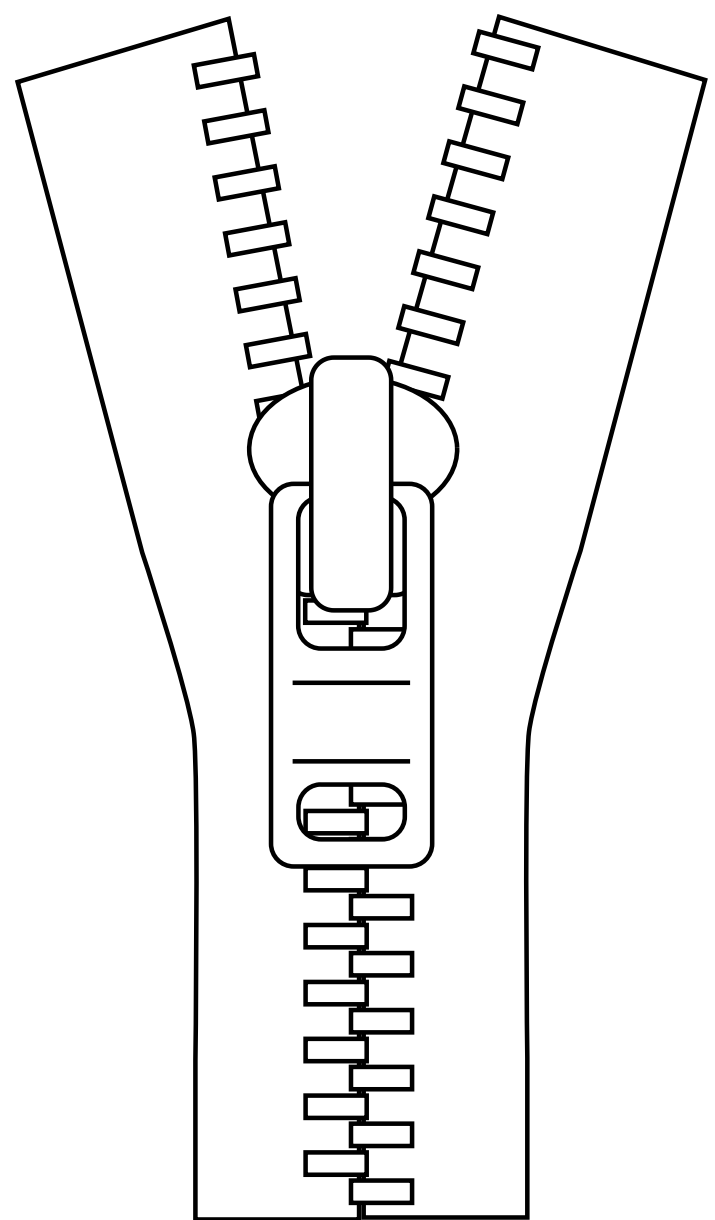
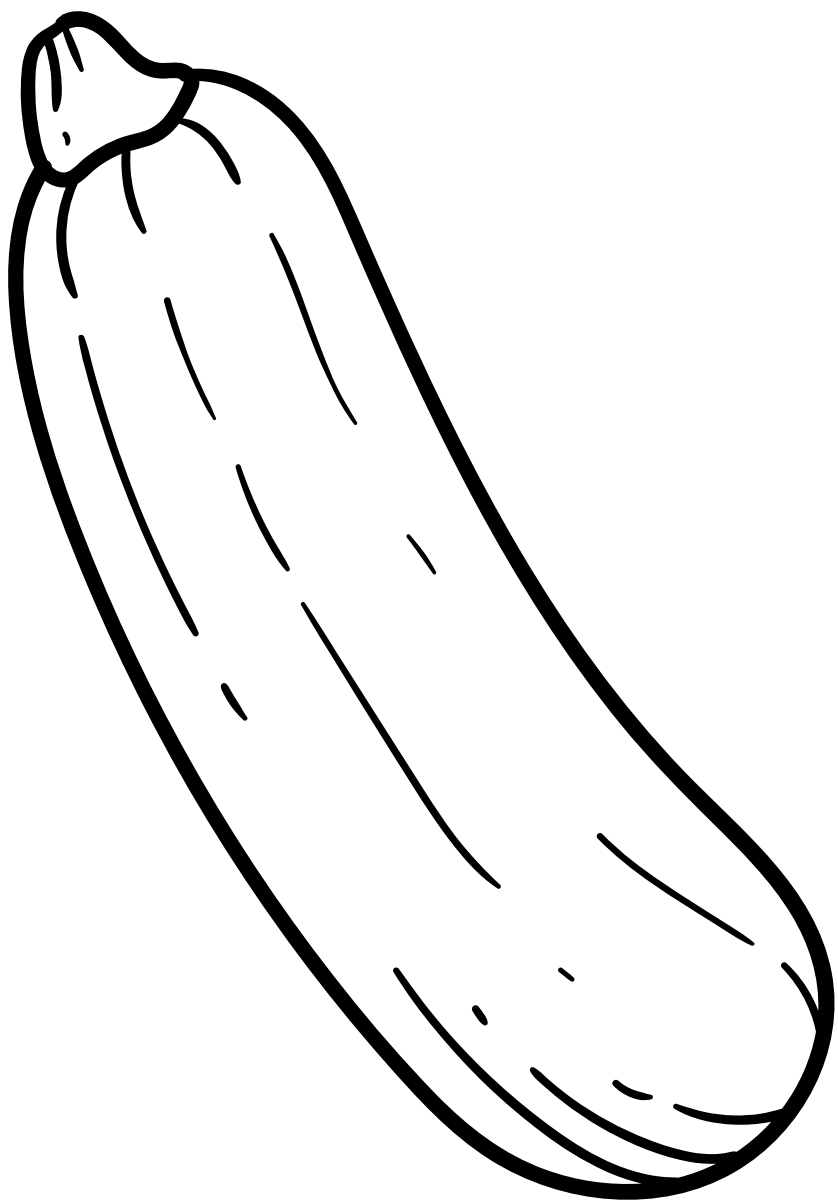
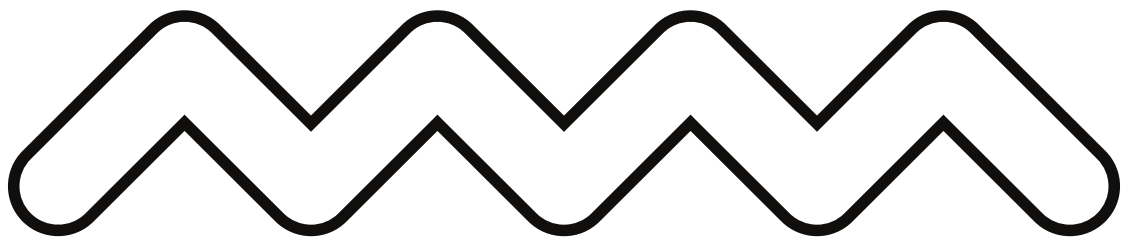
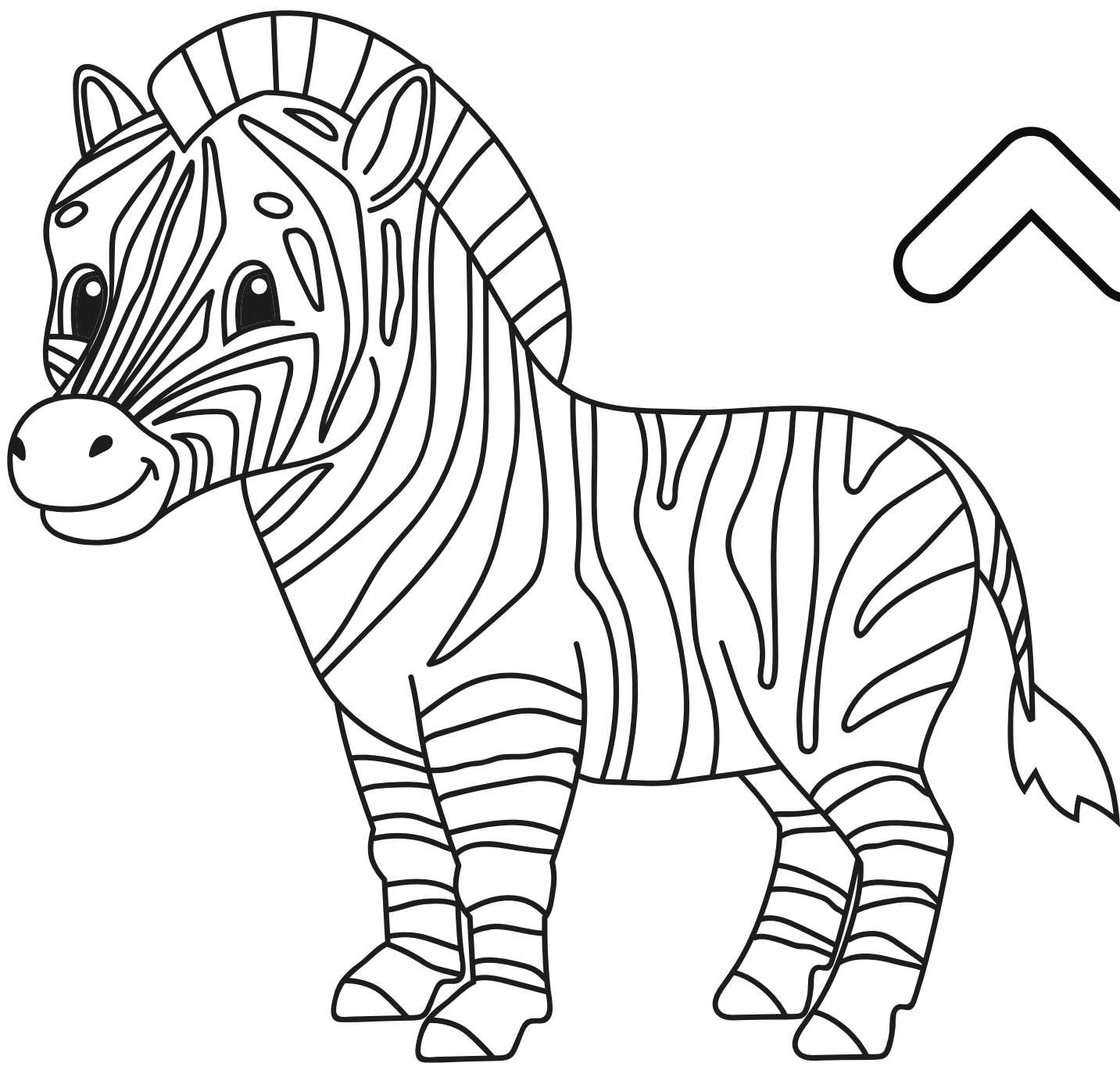



COLORS



Things that are color **RED**

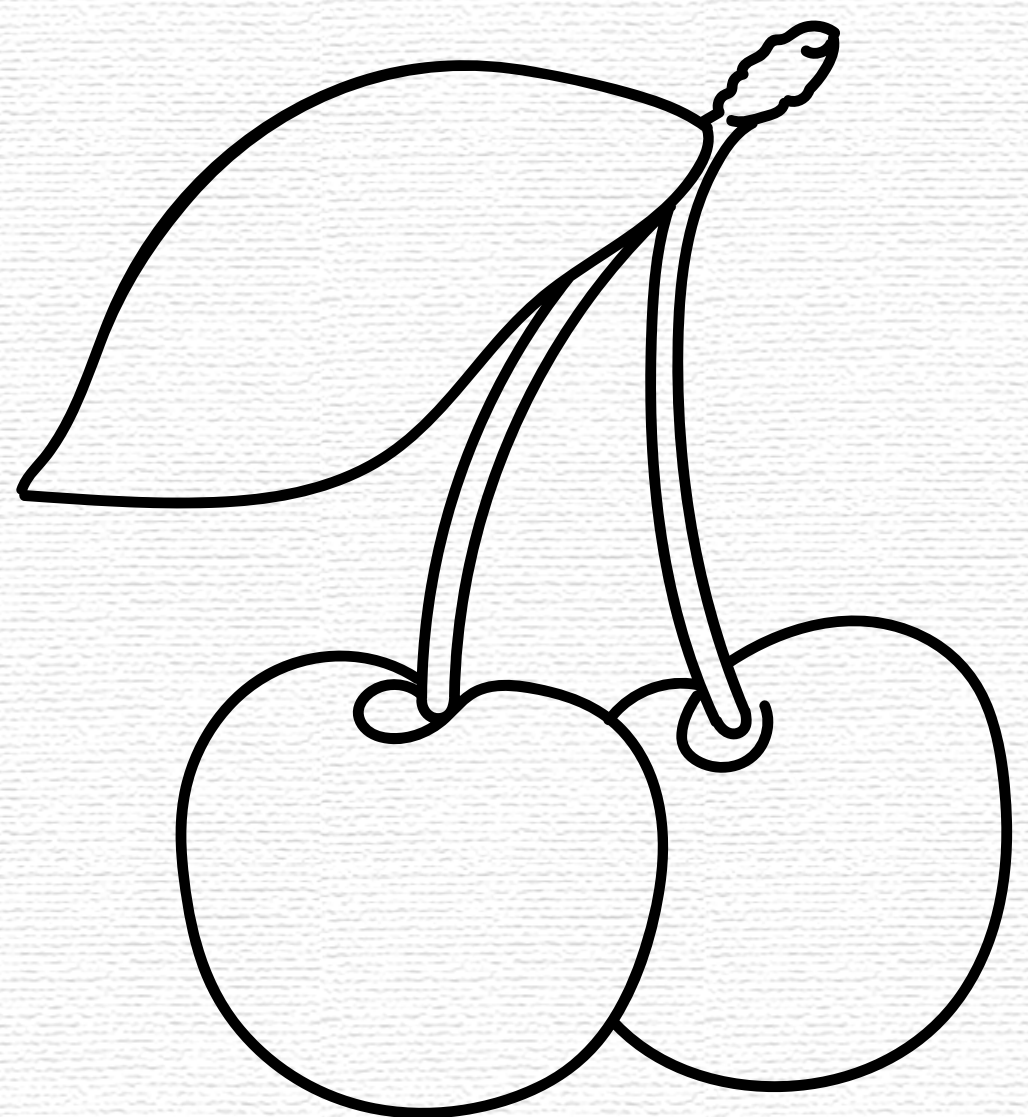
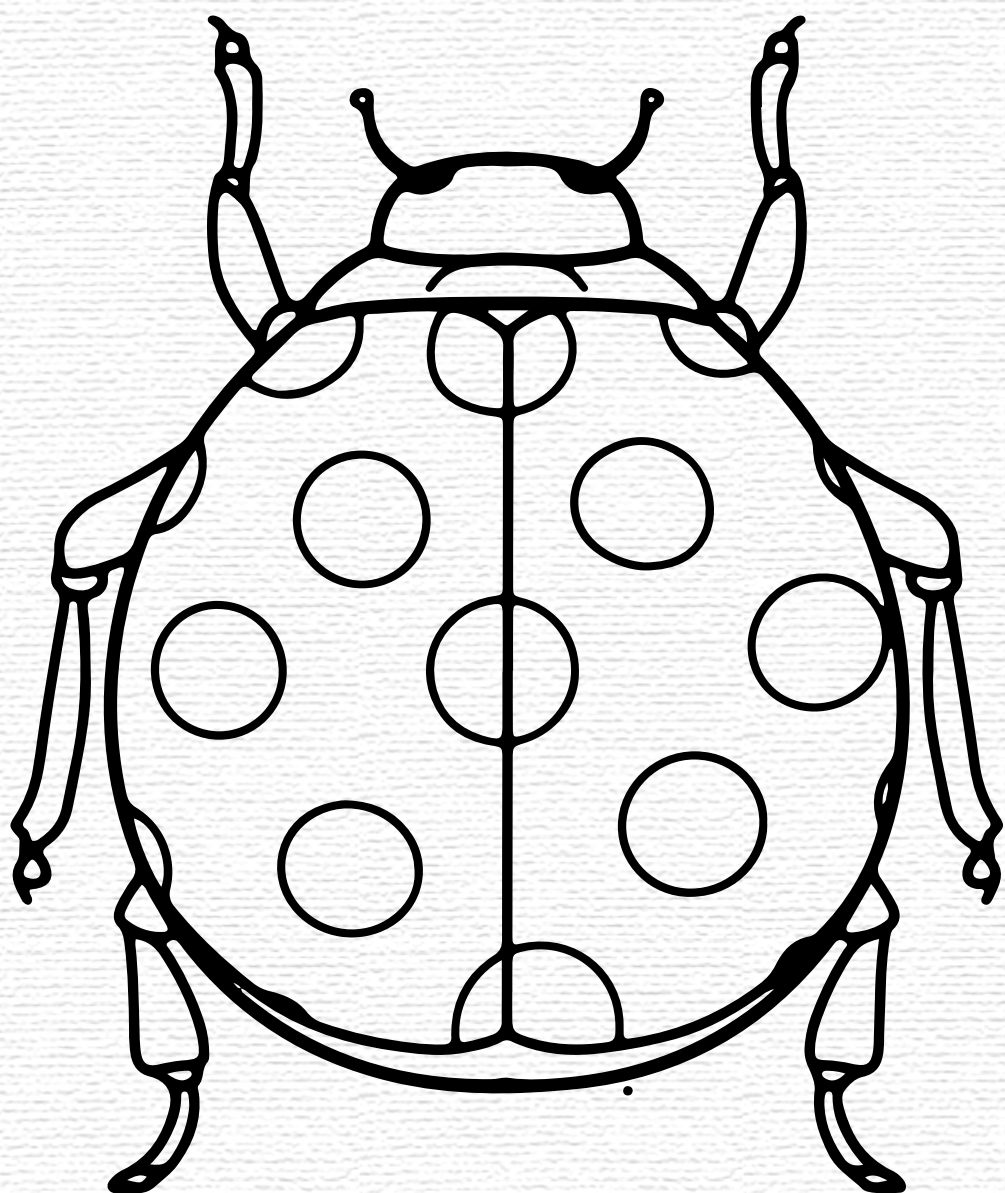
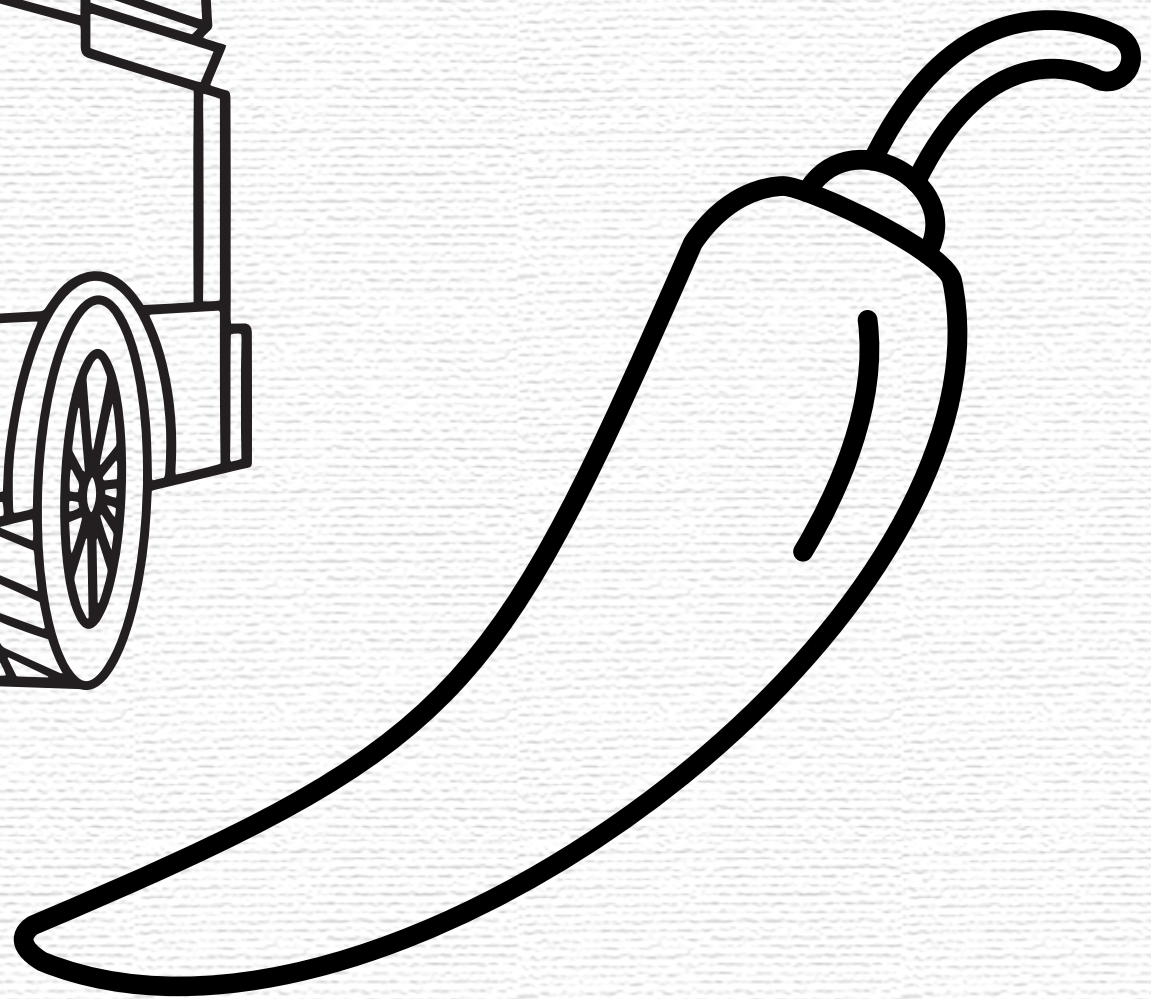
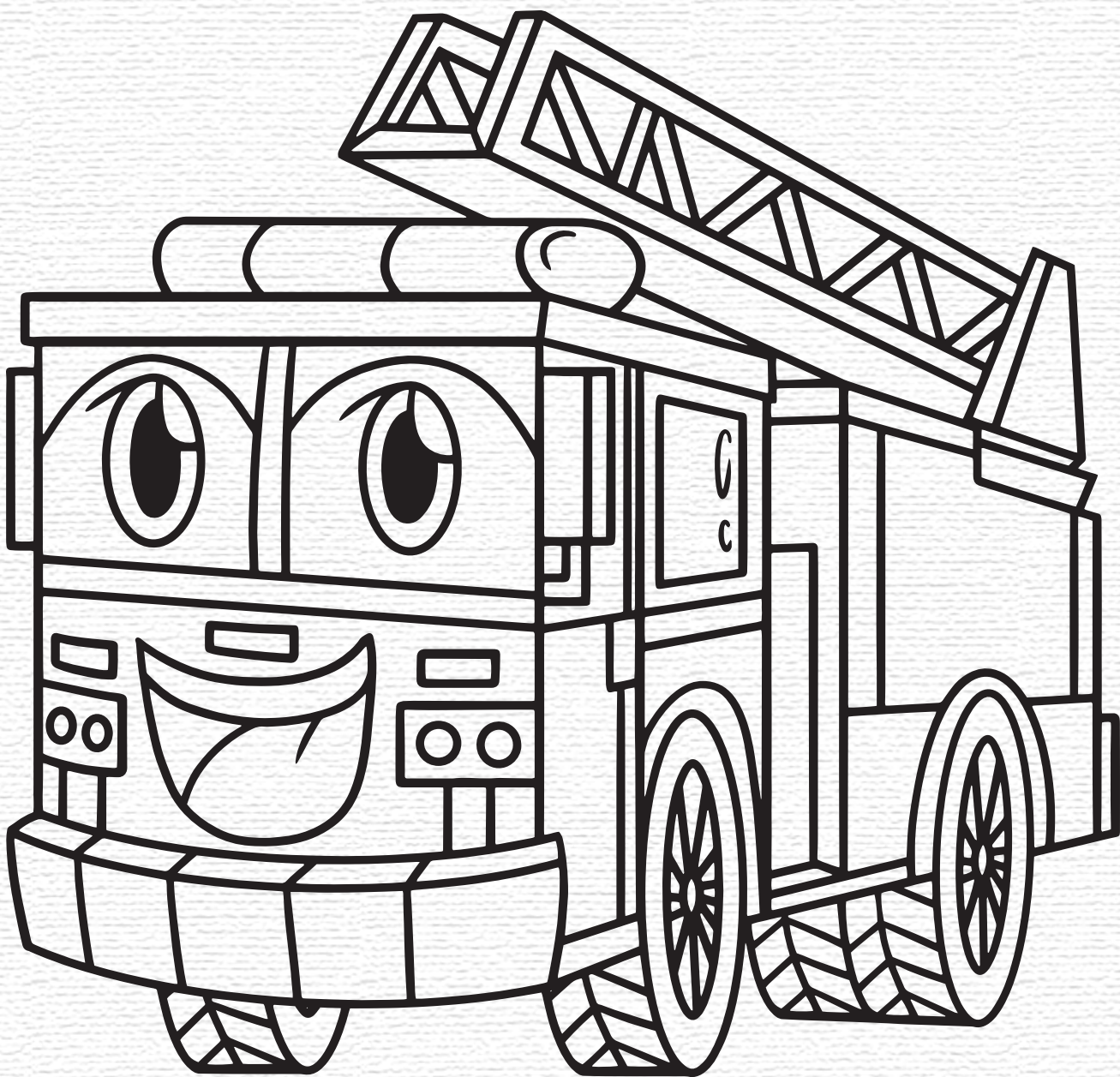
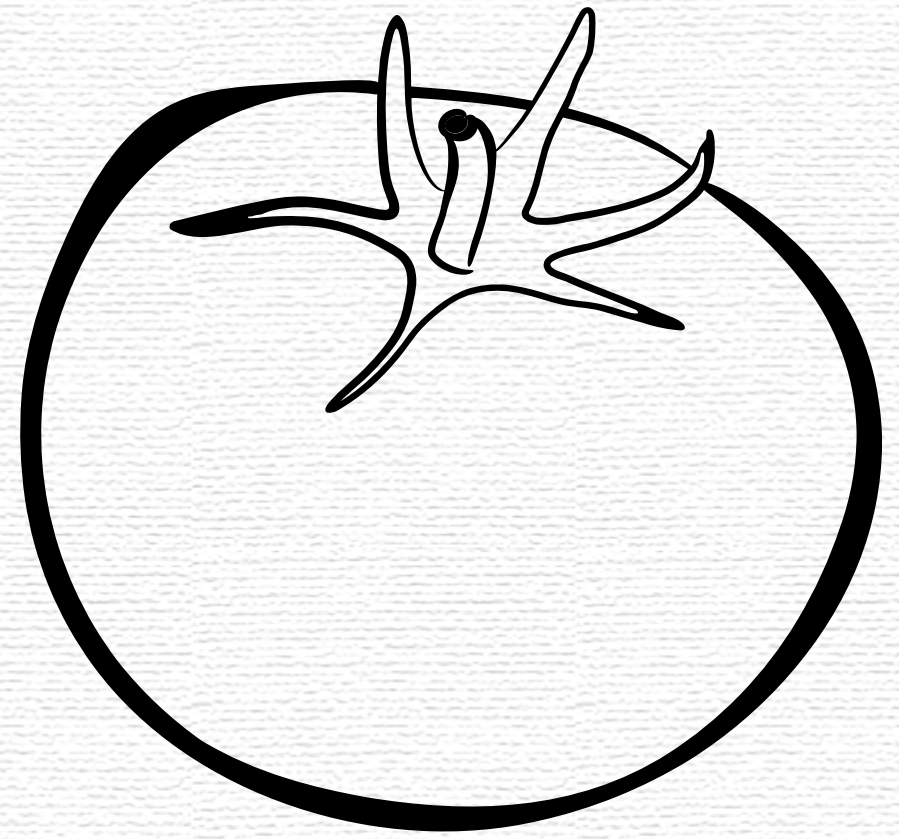
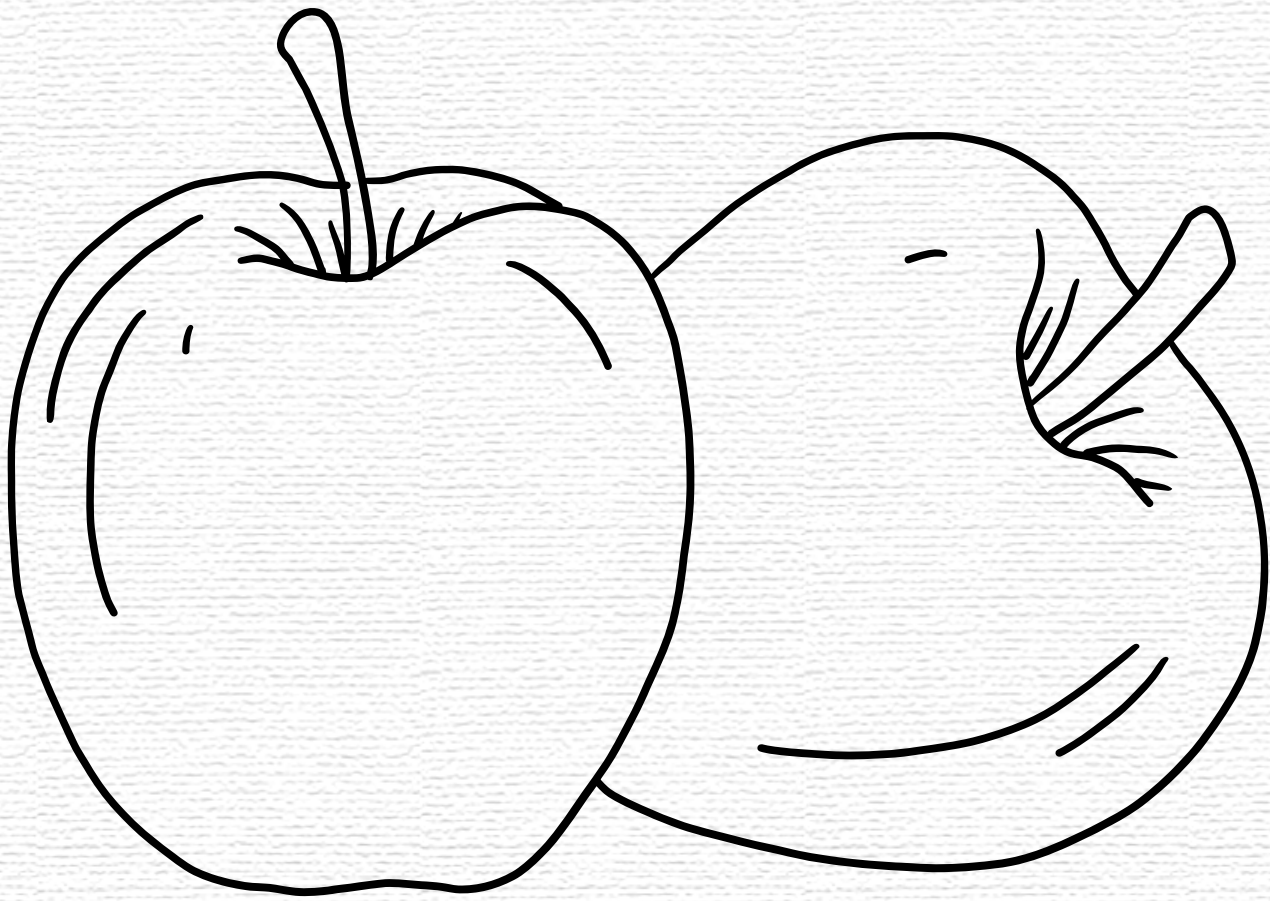

Things that are color **YELLOW**

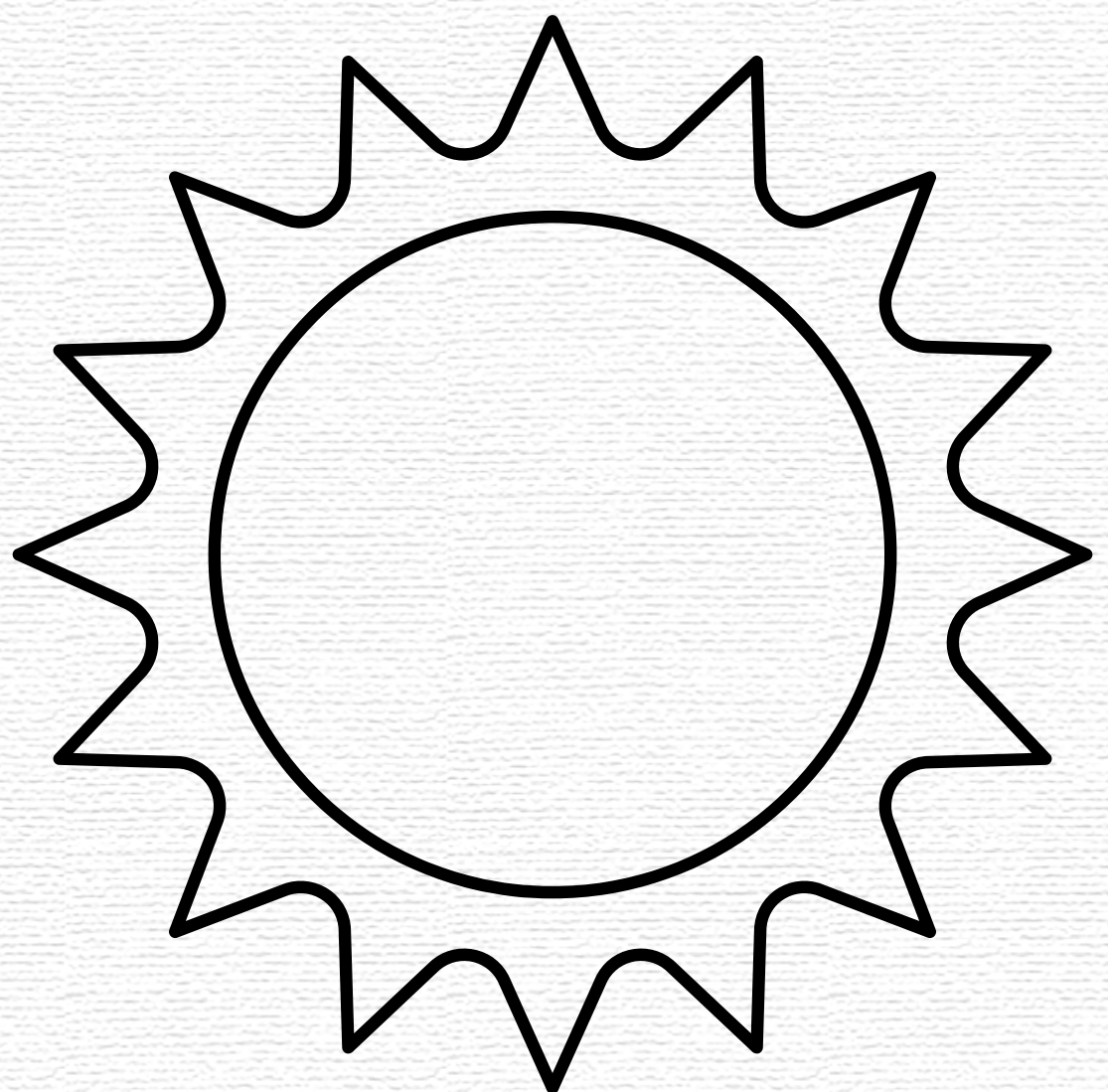
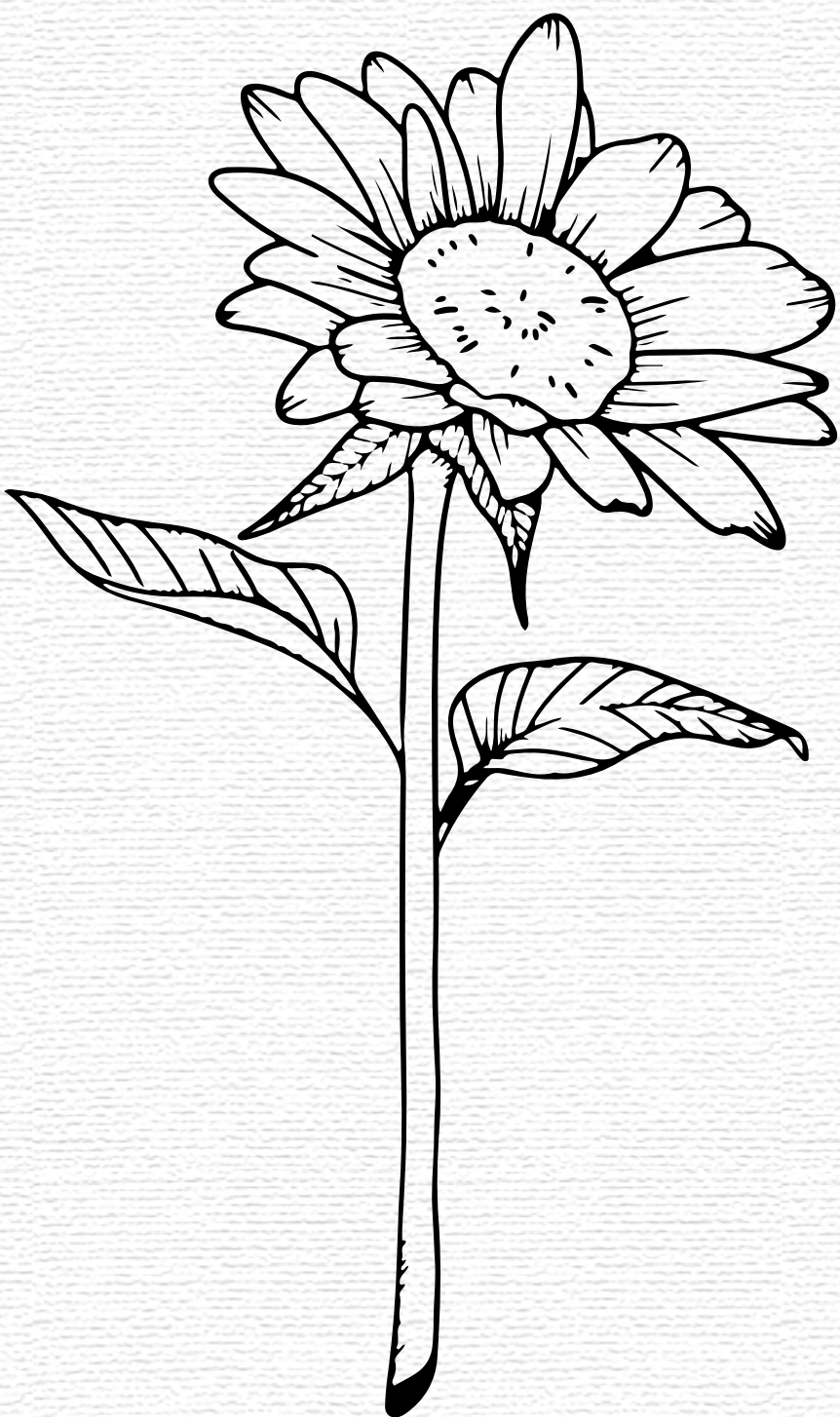
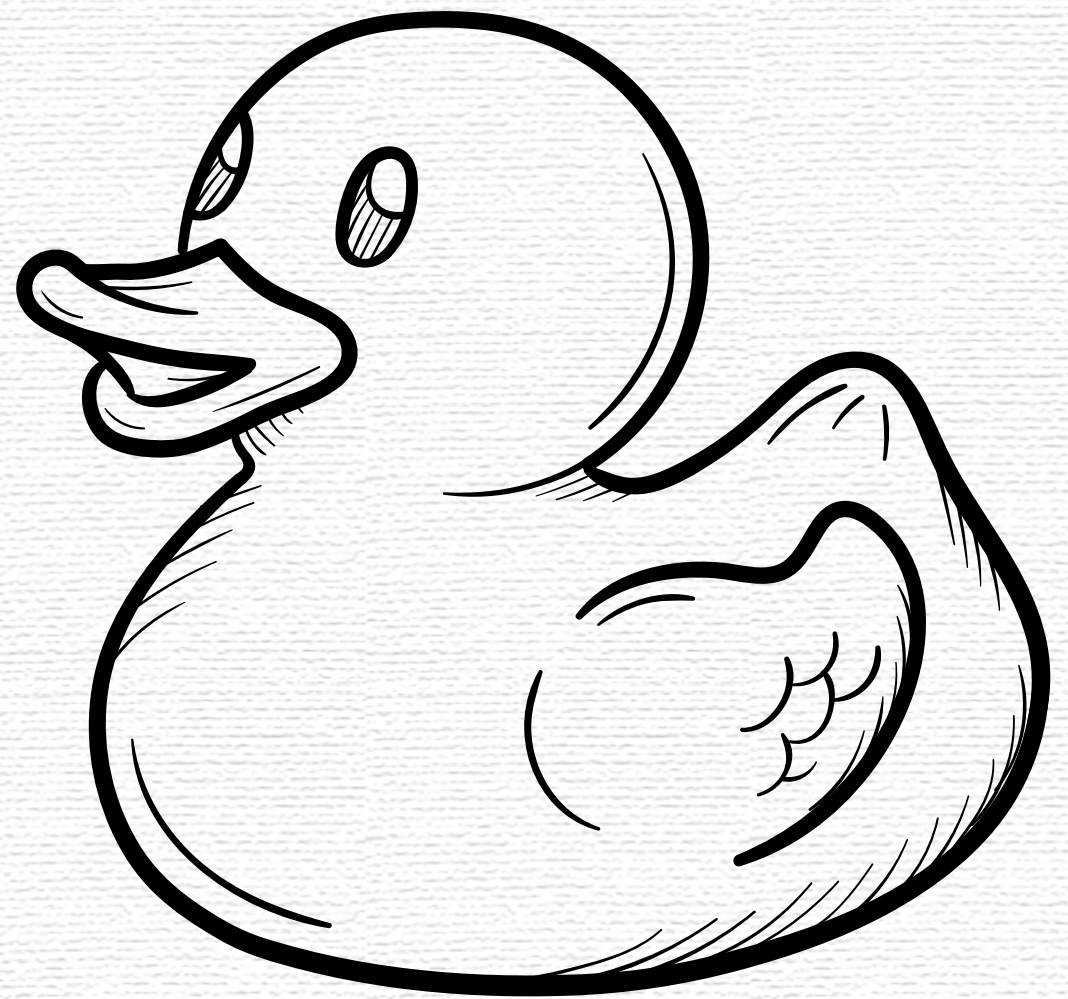
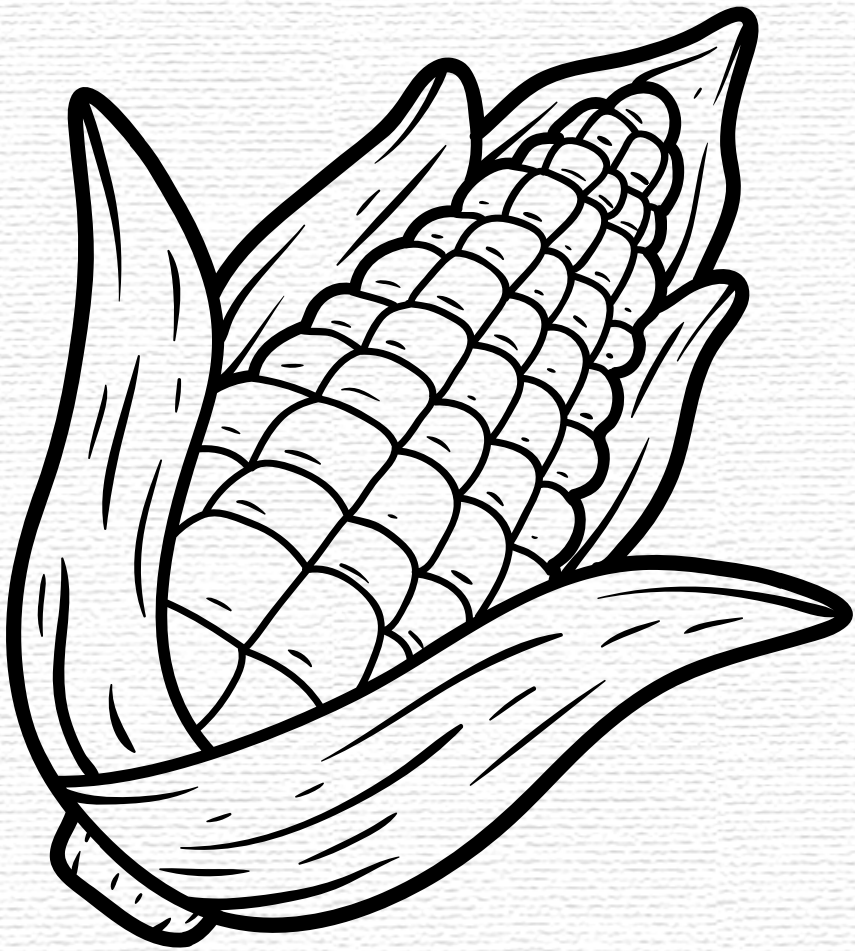
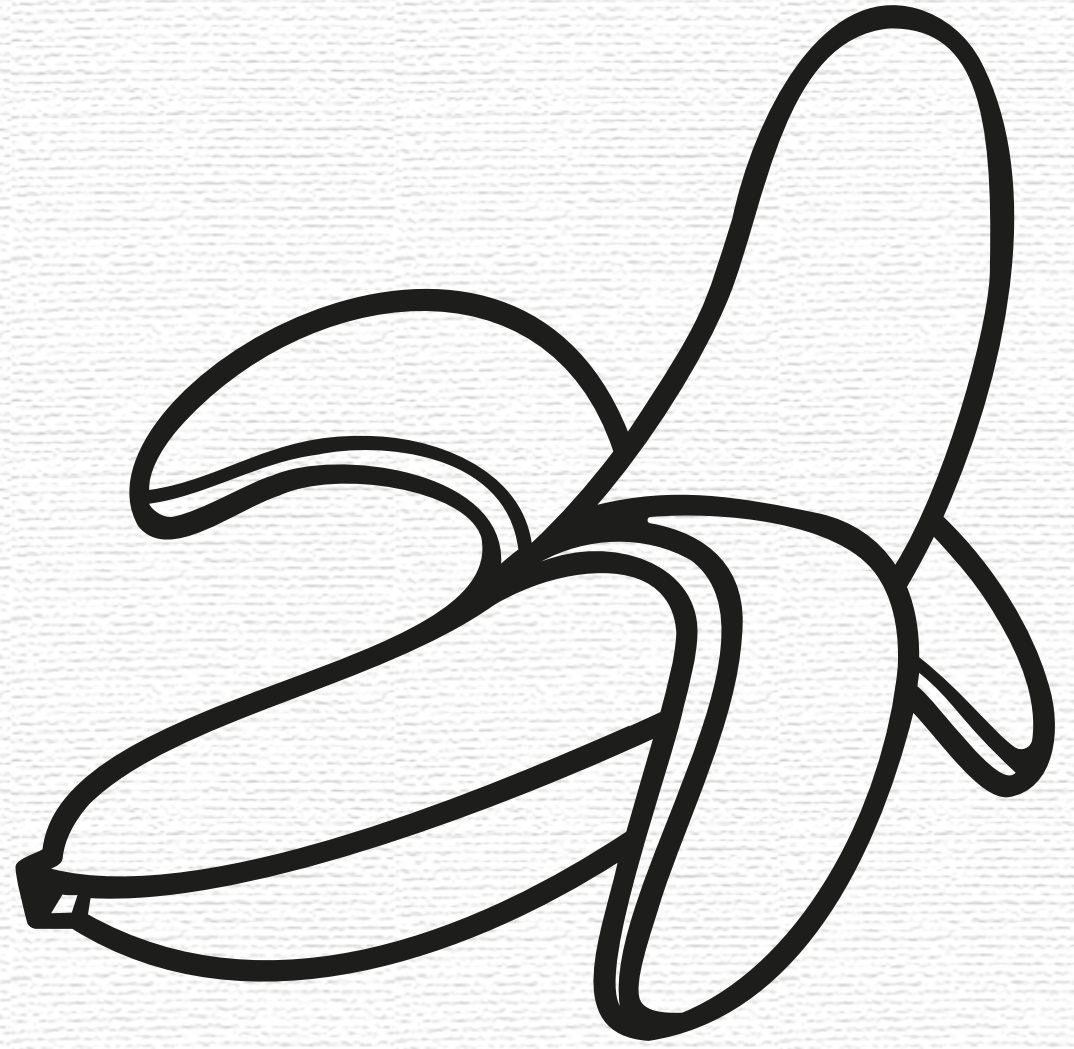
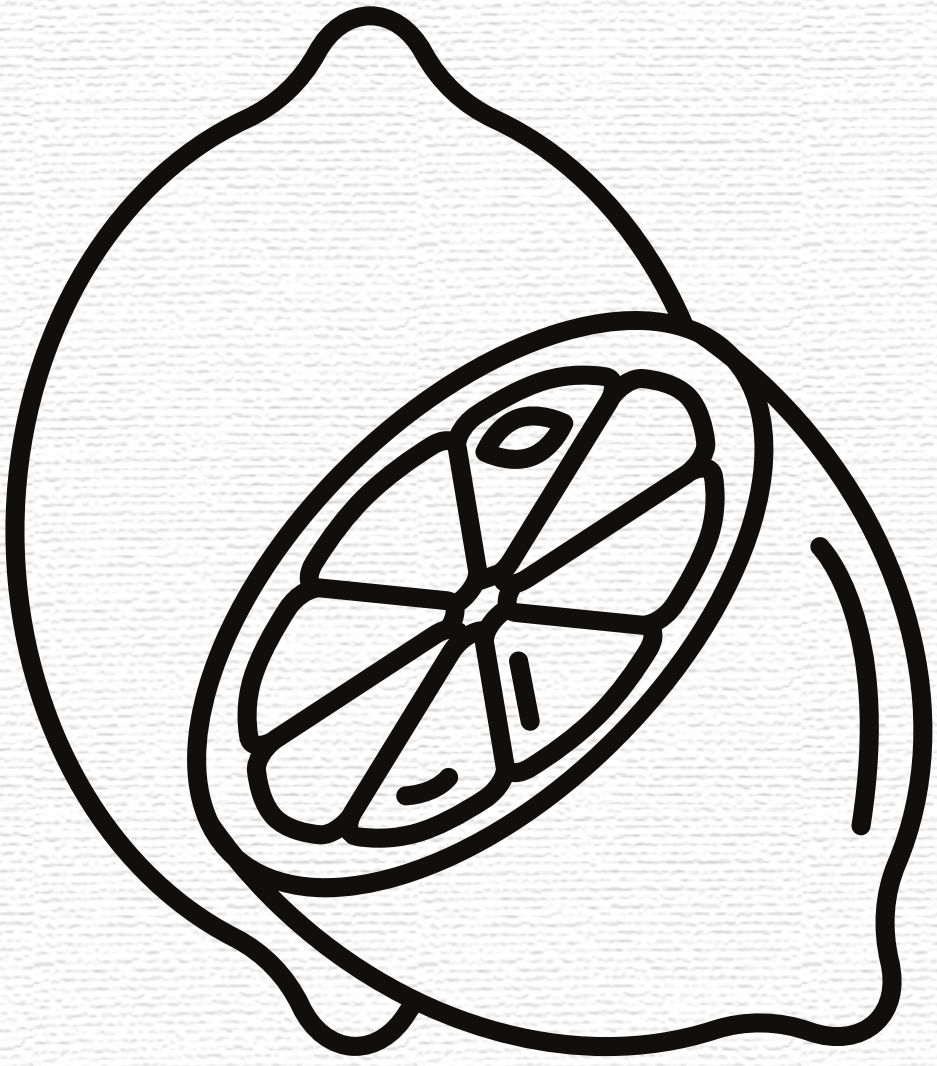

Things that are color **GREEN**

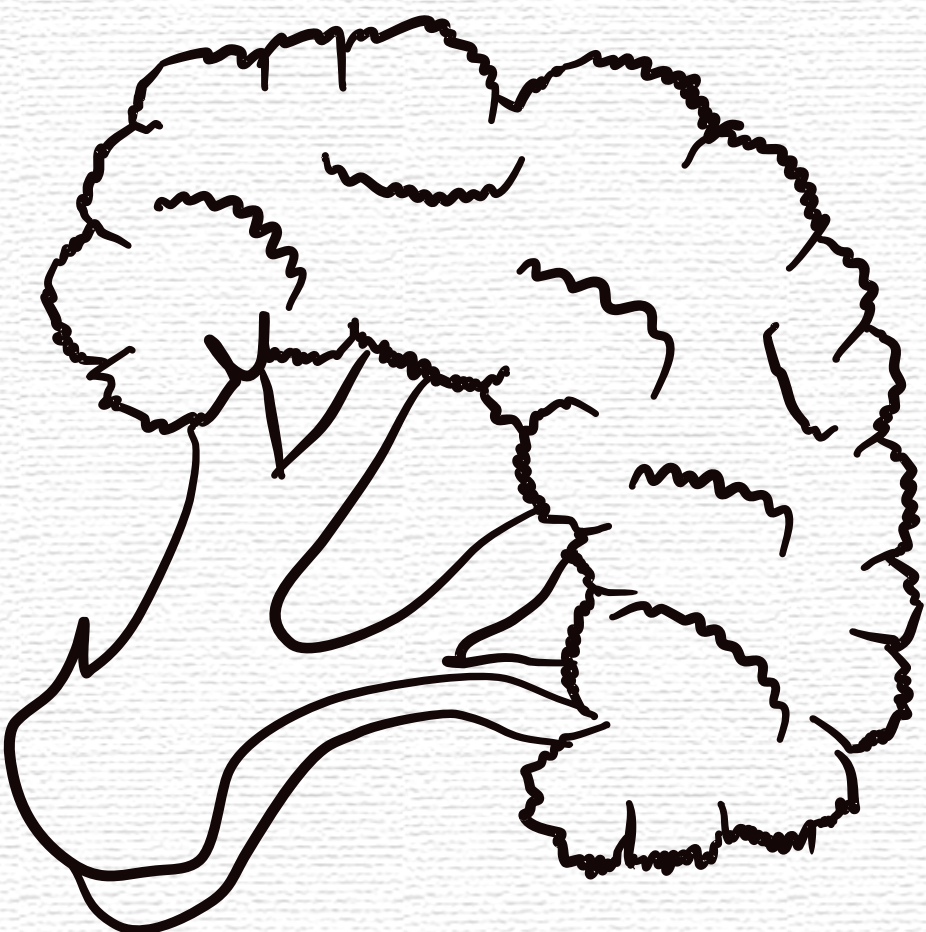
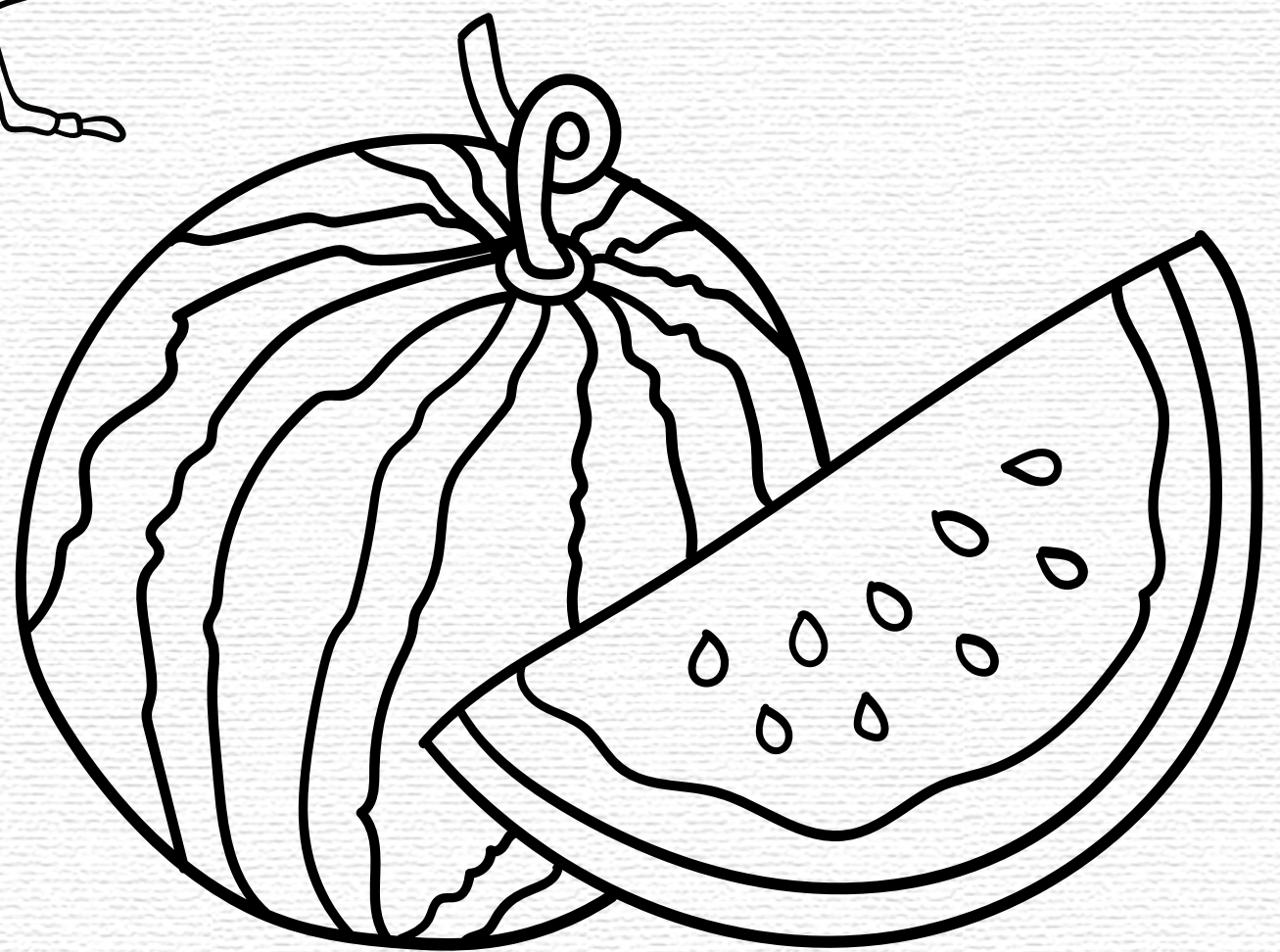
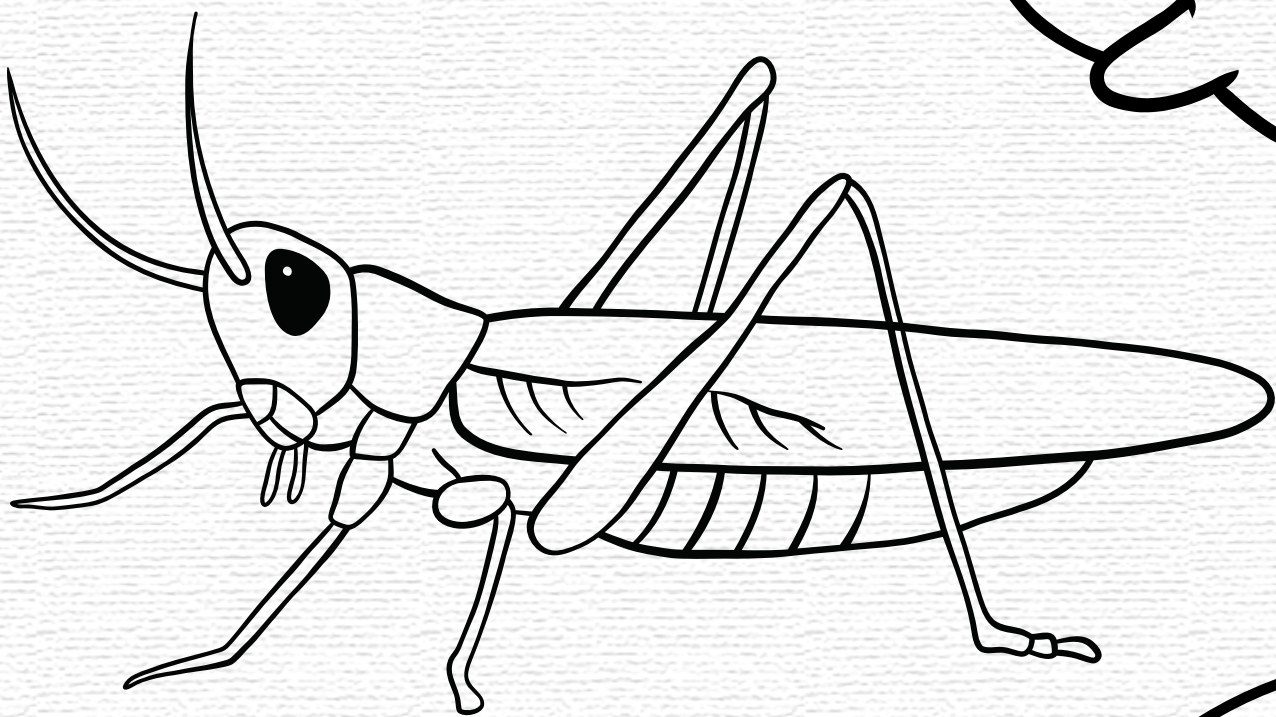
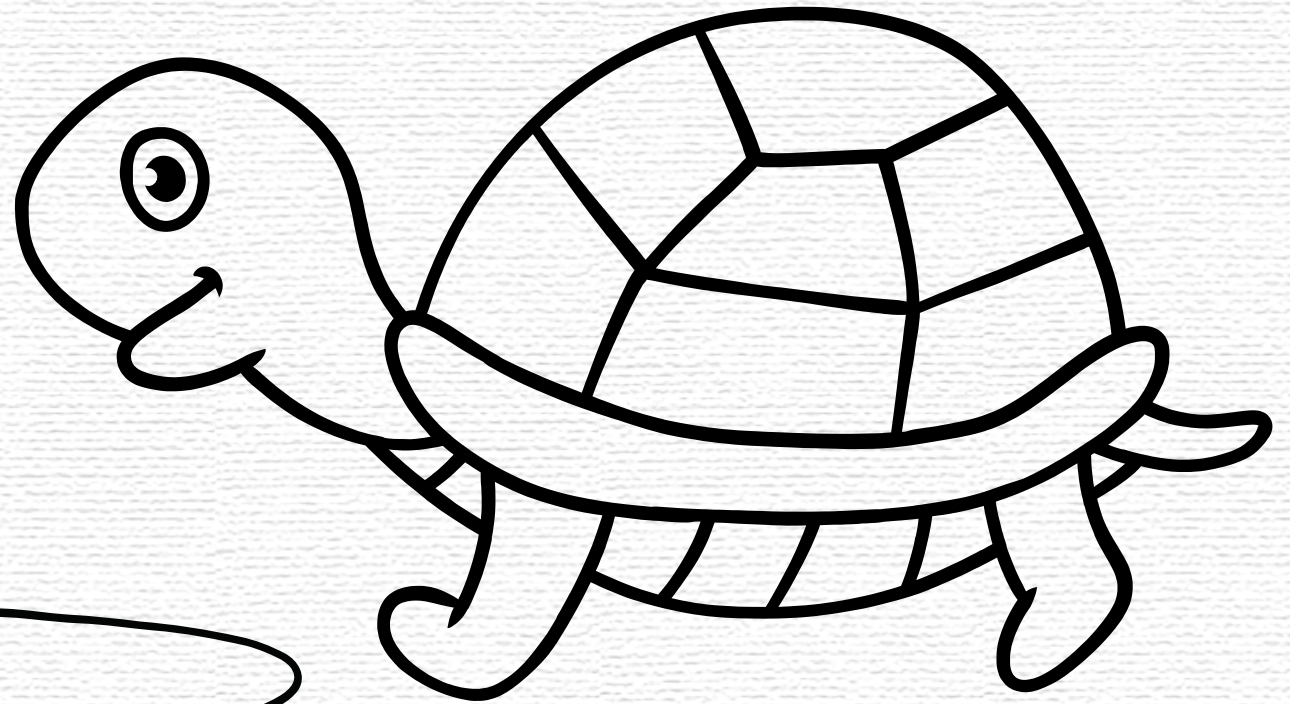
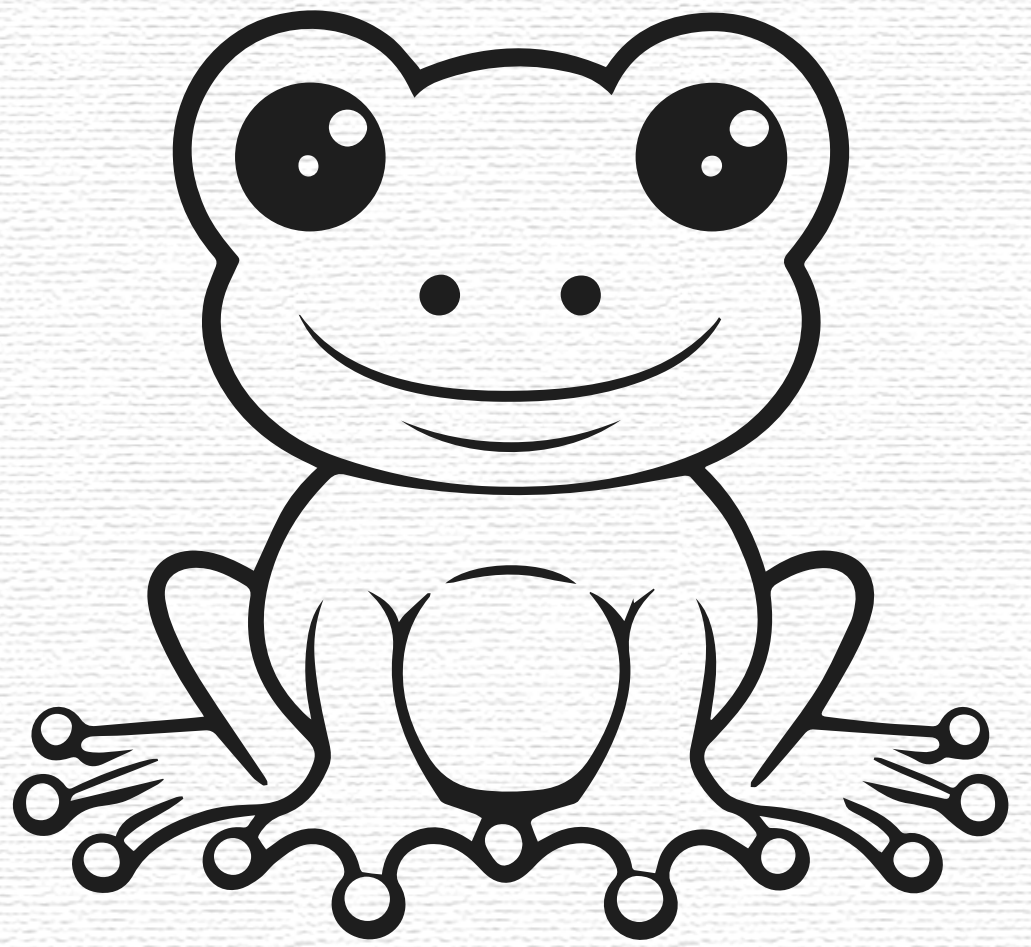
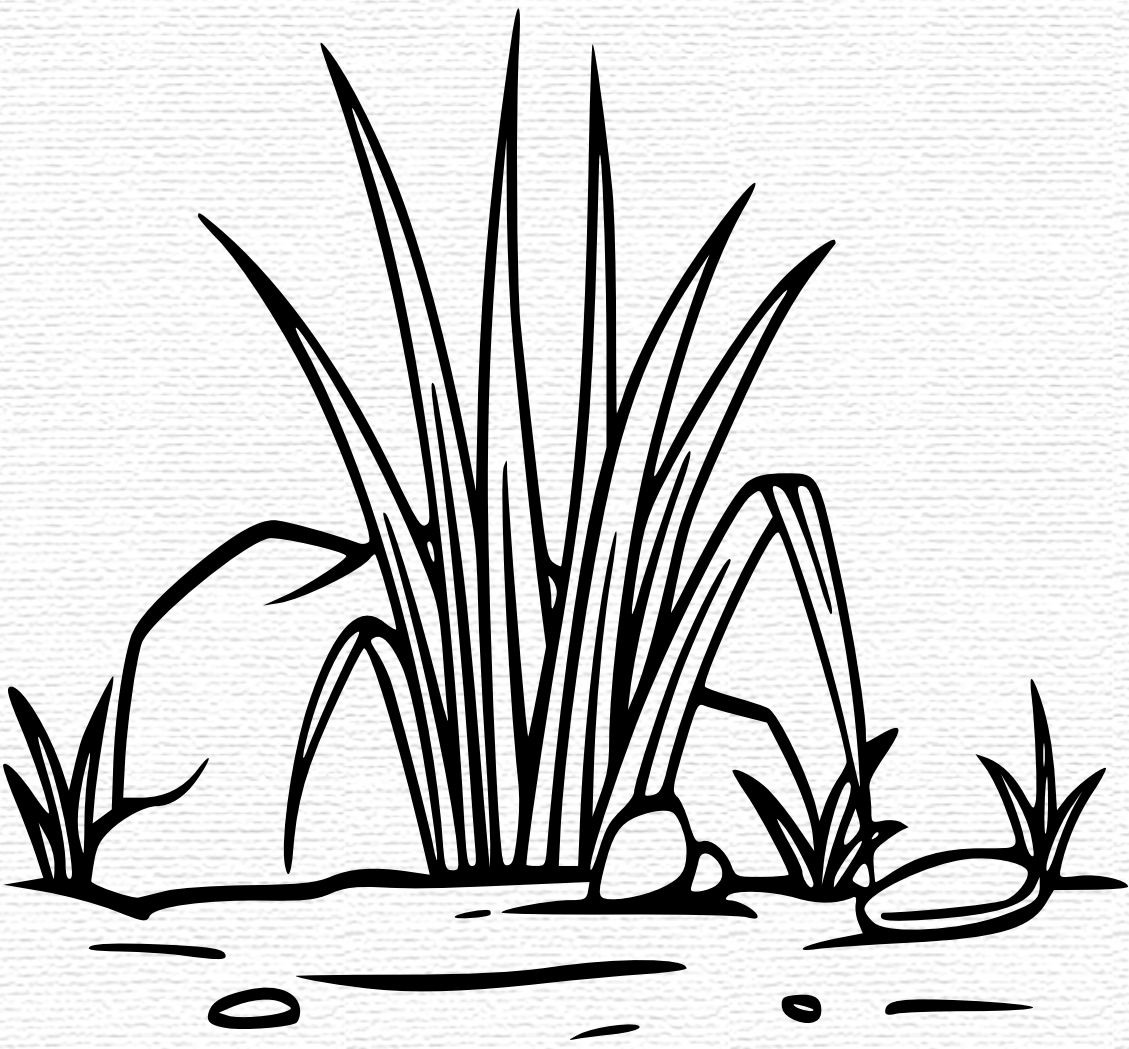

Things that are color **ORANGE**

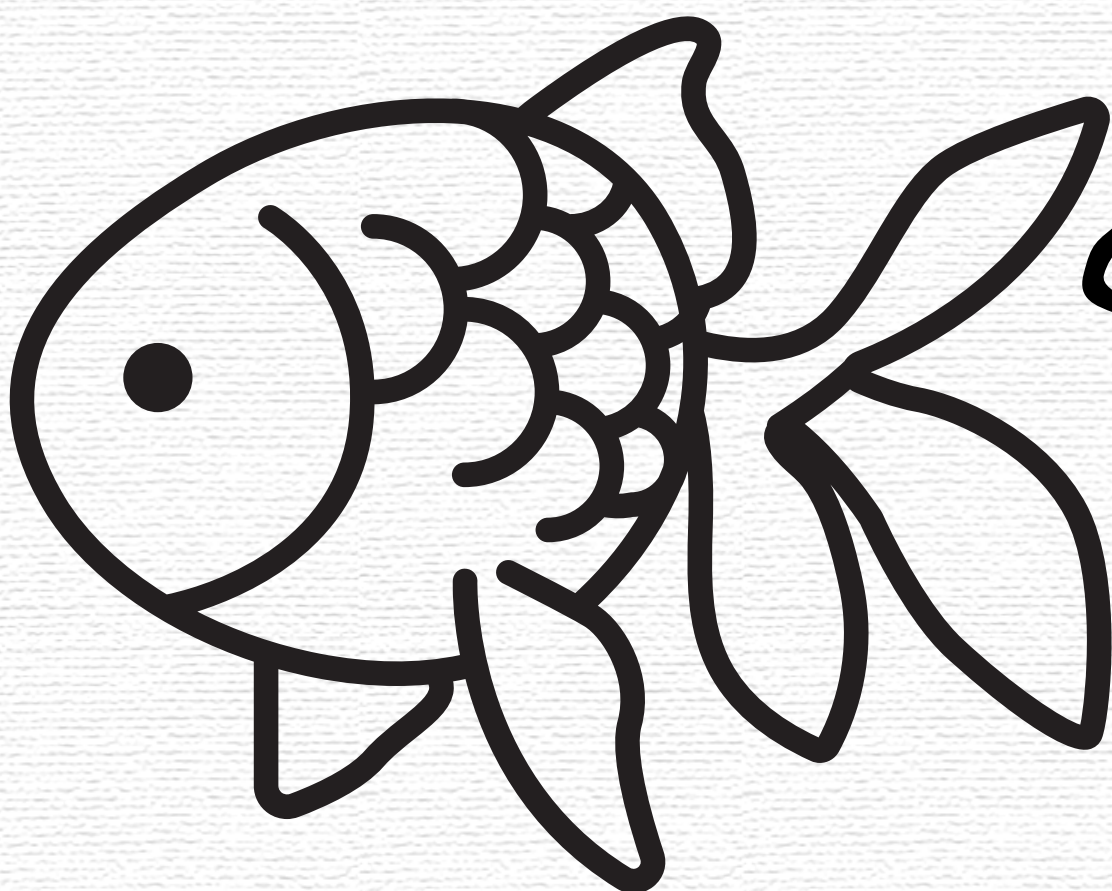
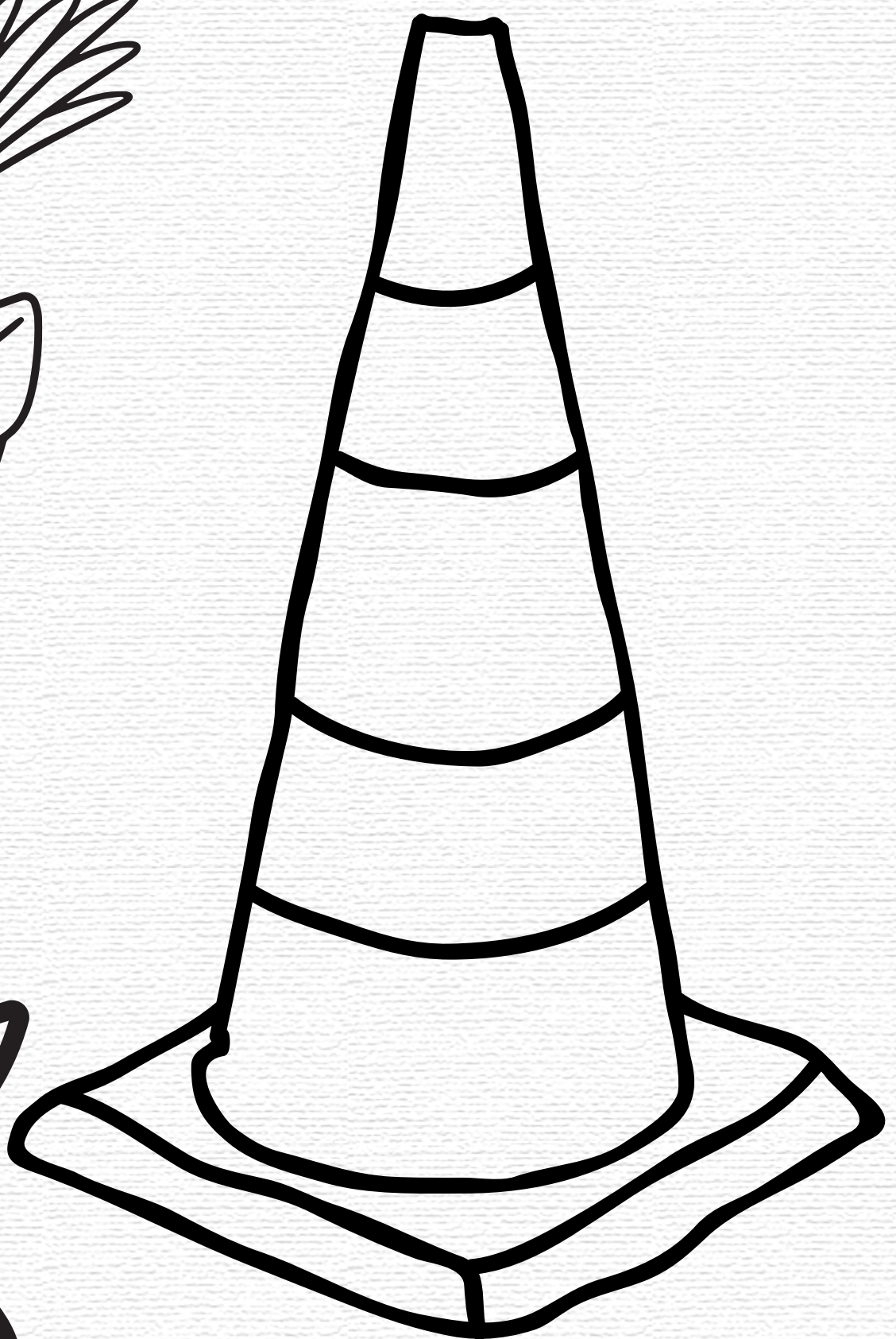
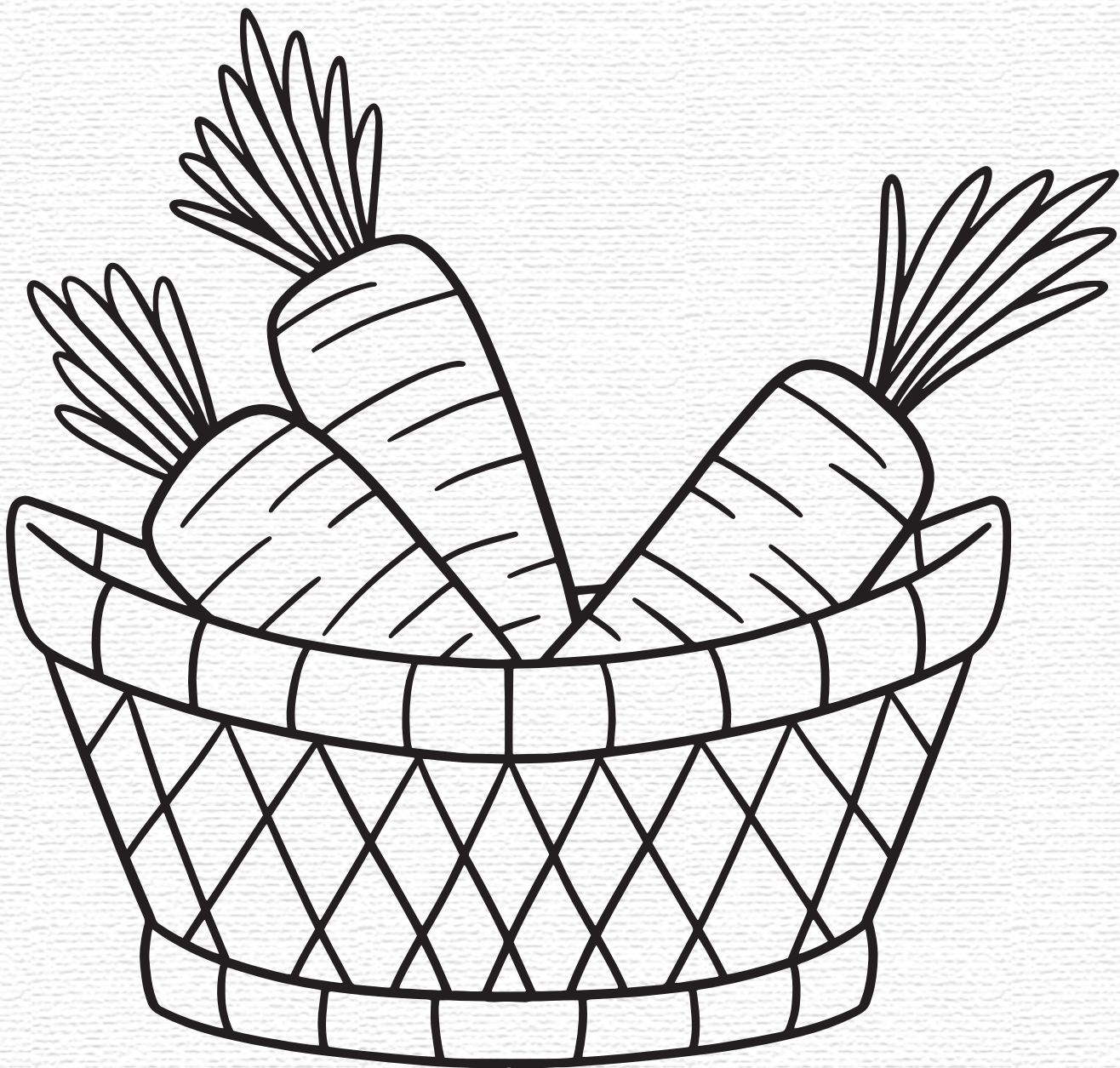
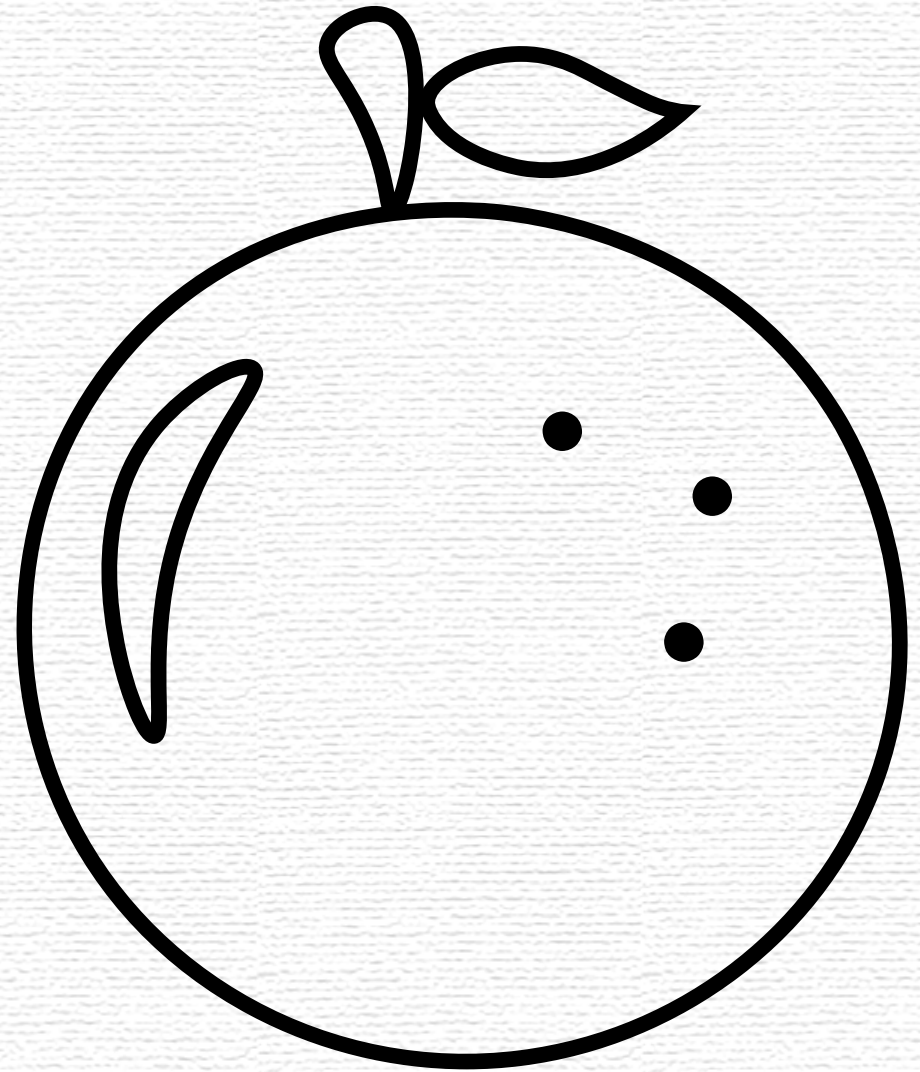

Things that are color **PURPLE**

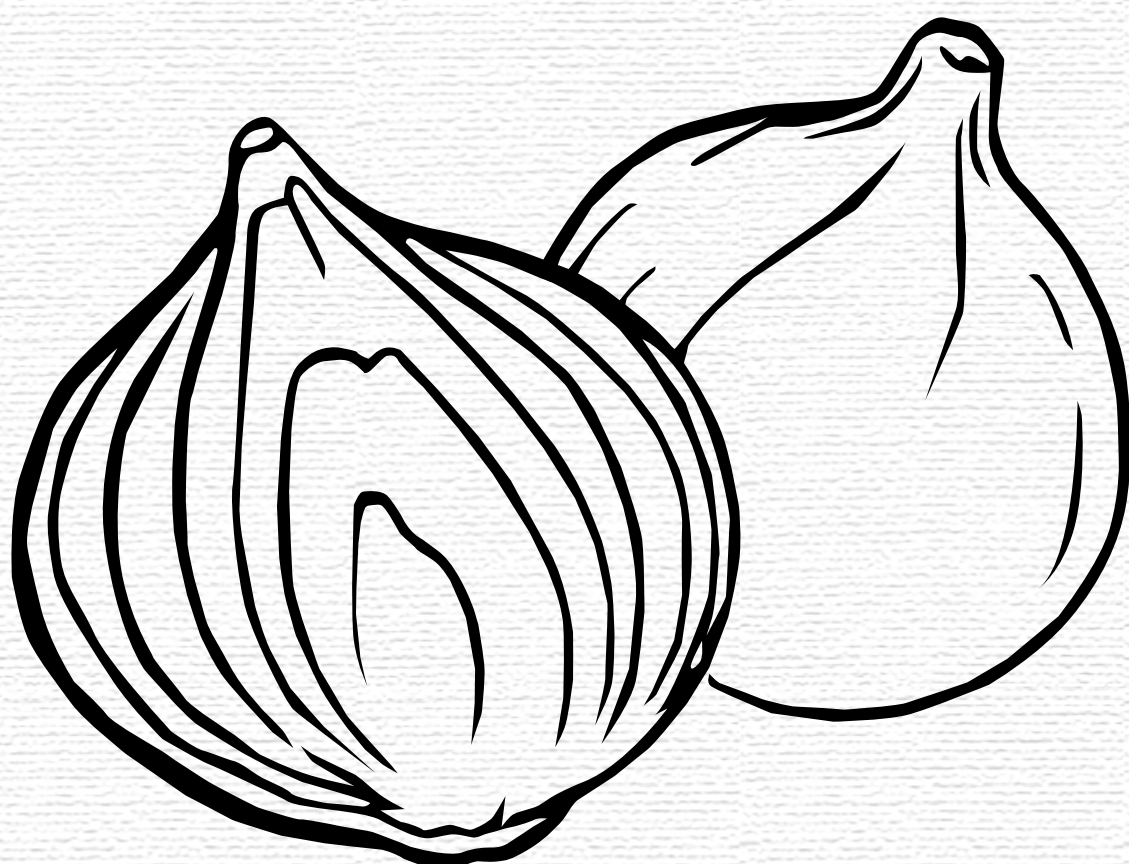
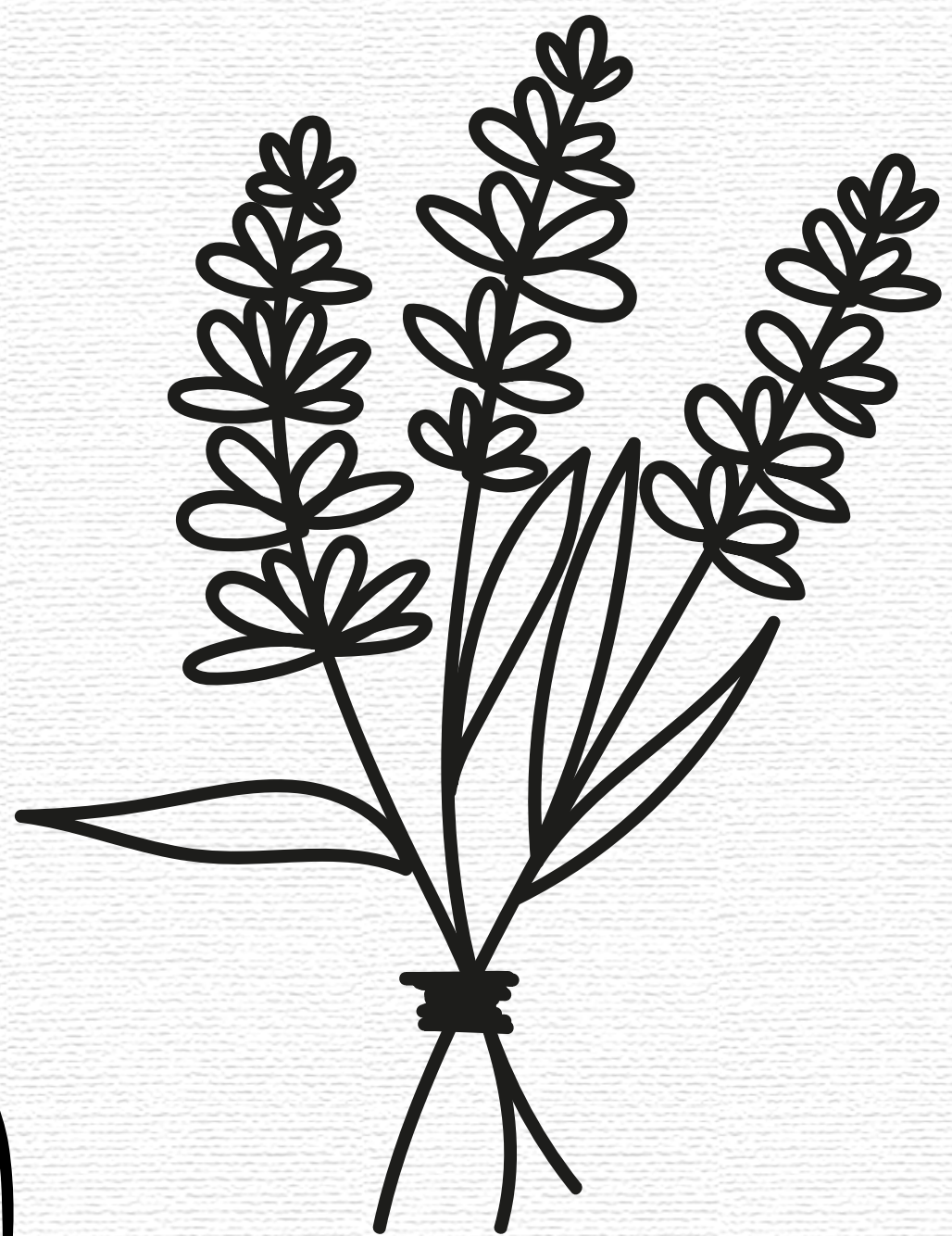
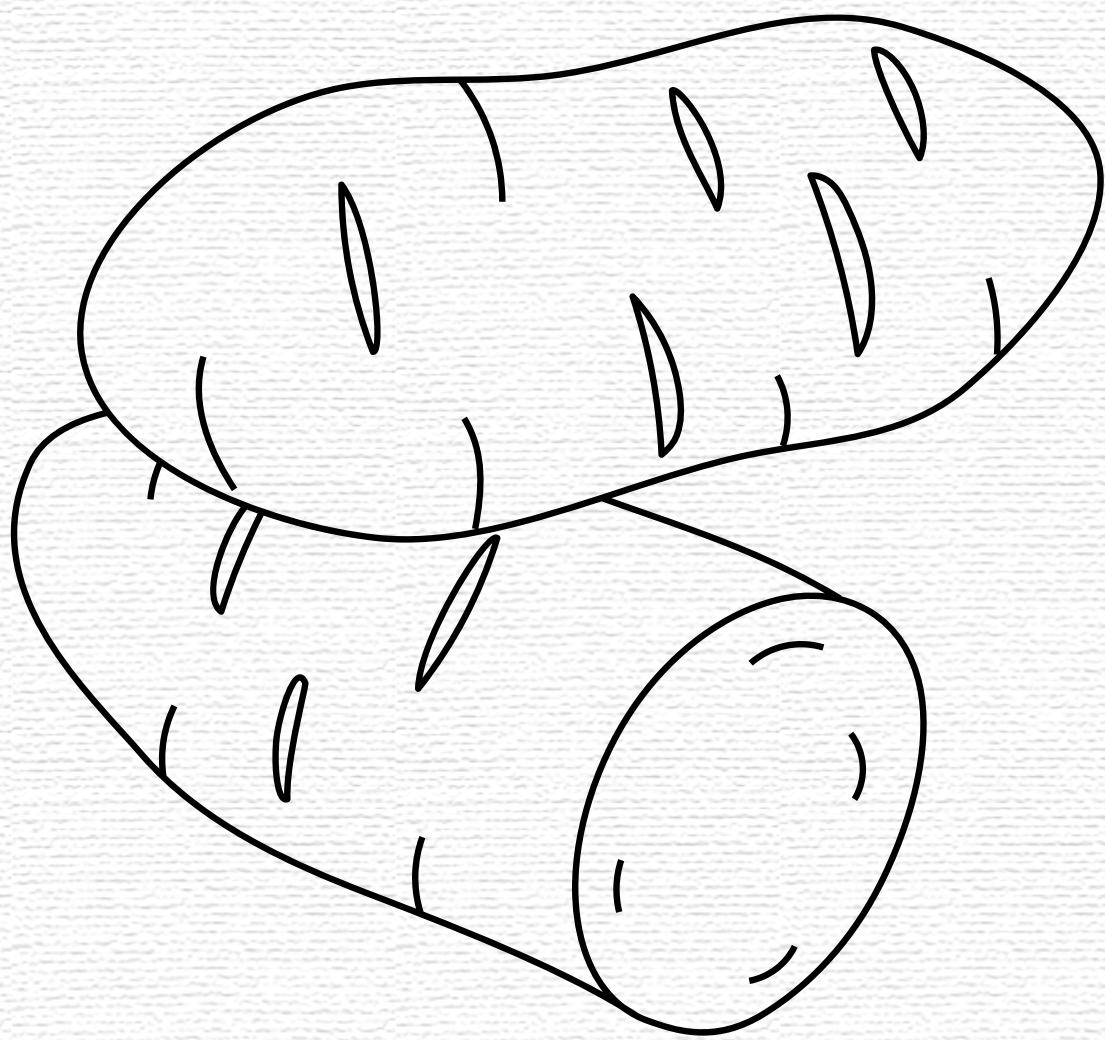
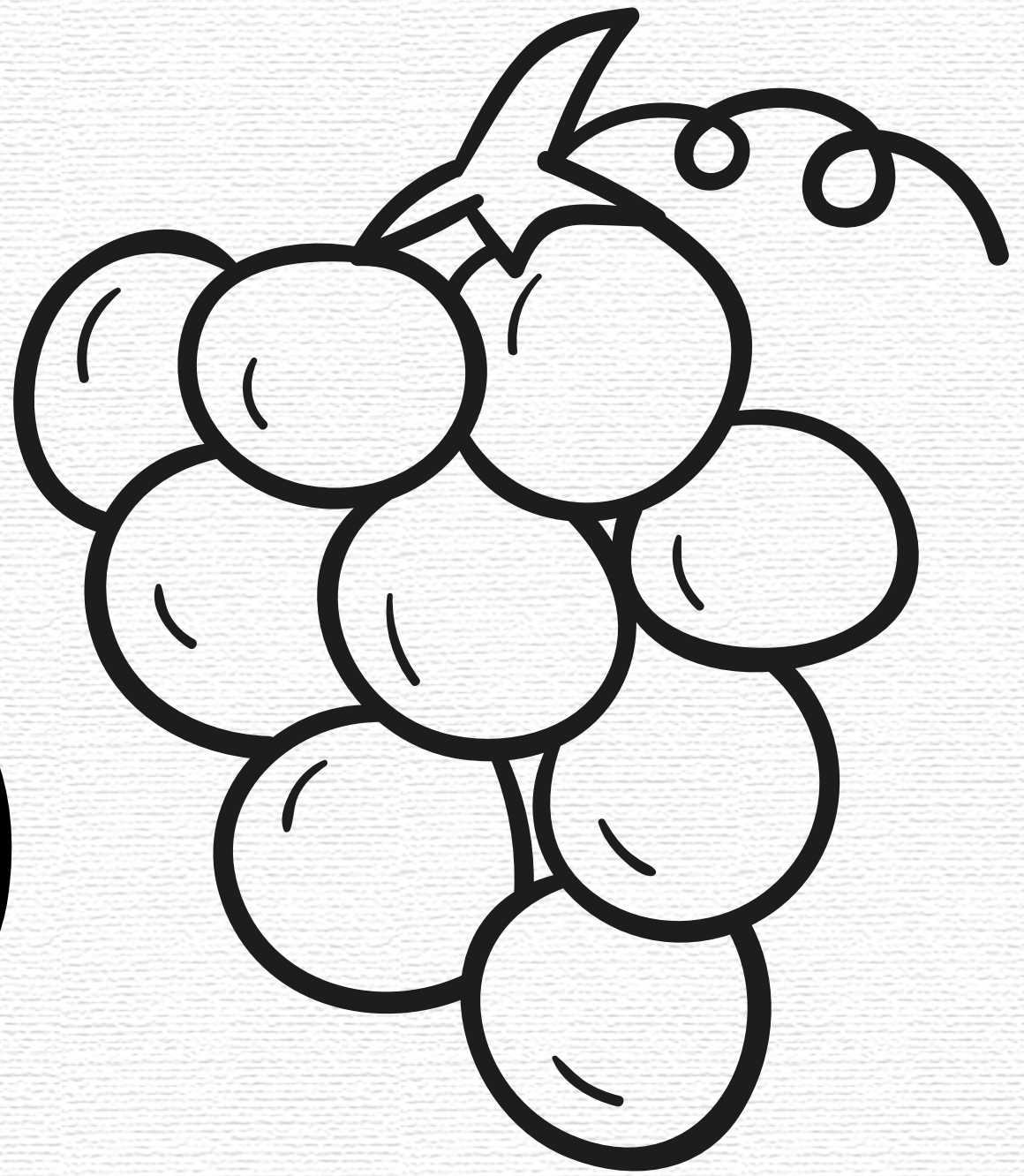
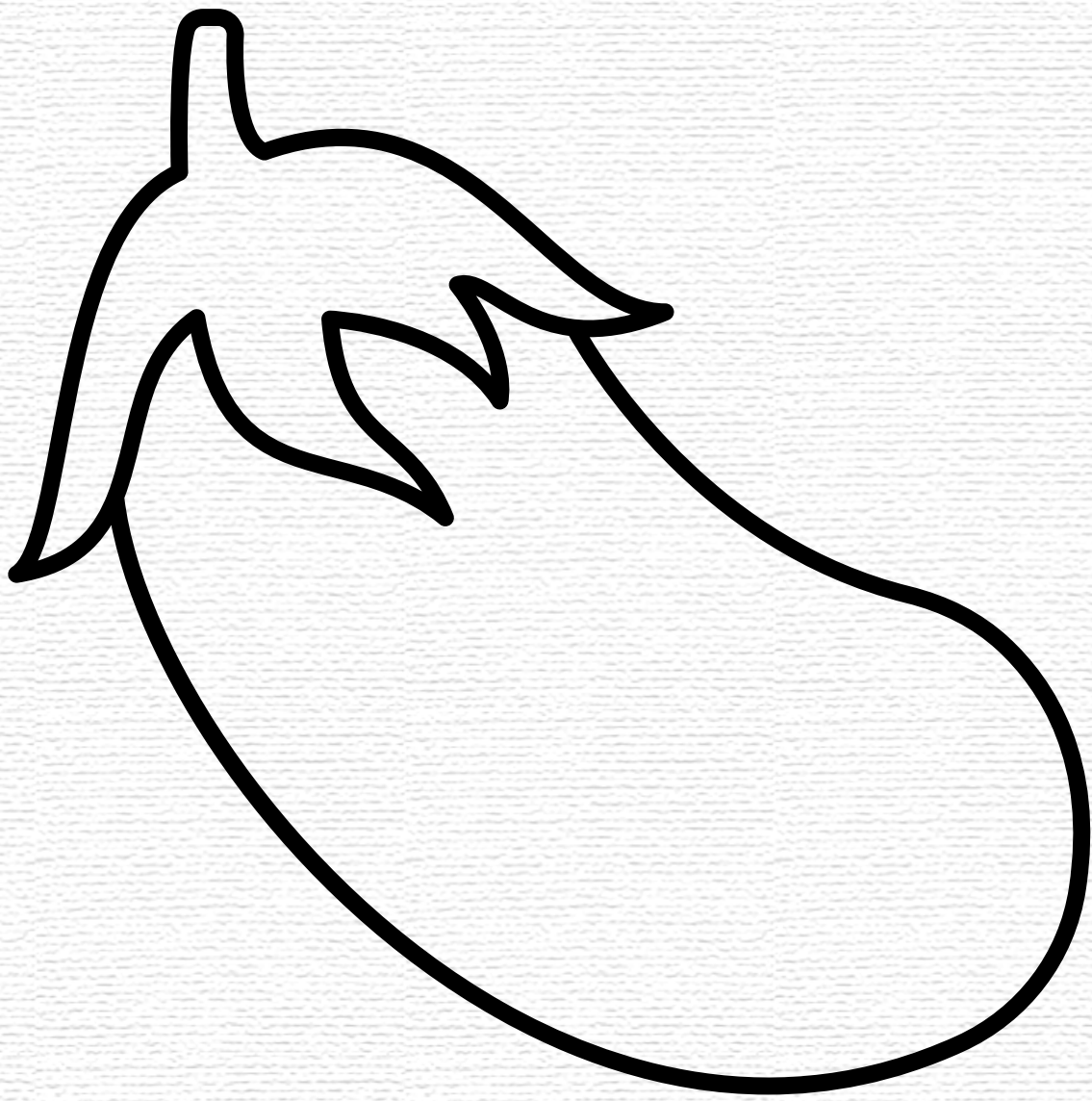

Things that are color **BLUE**

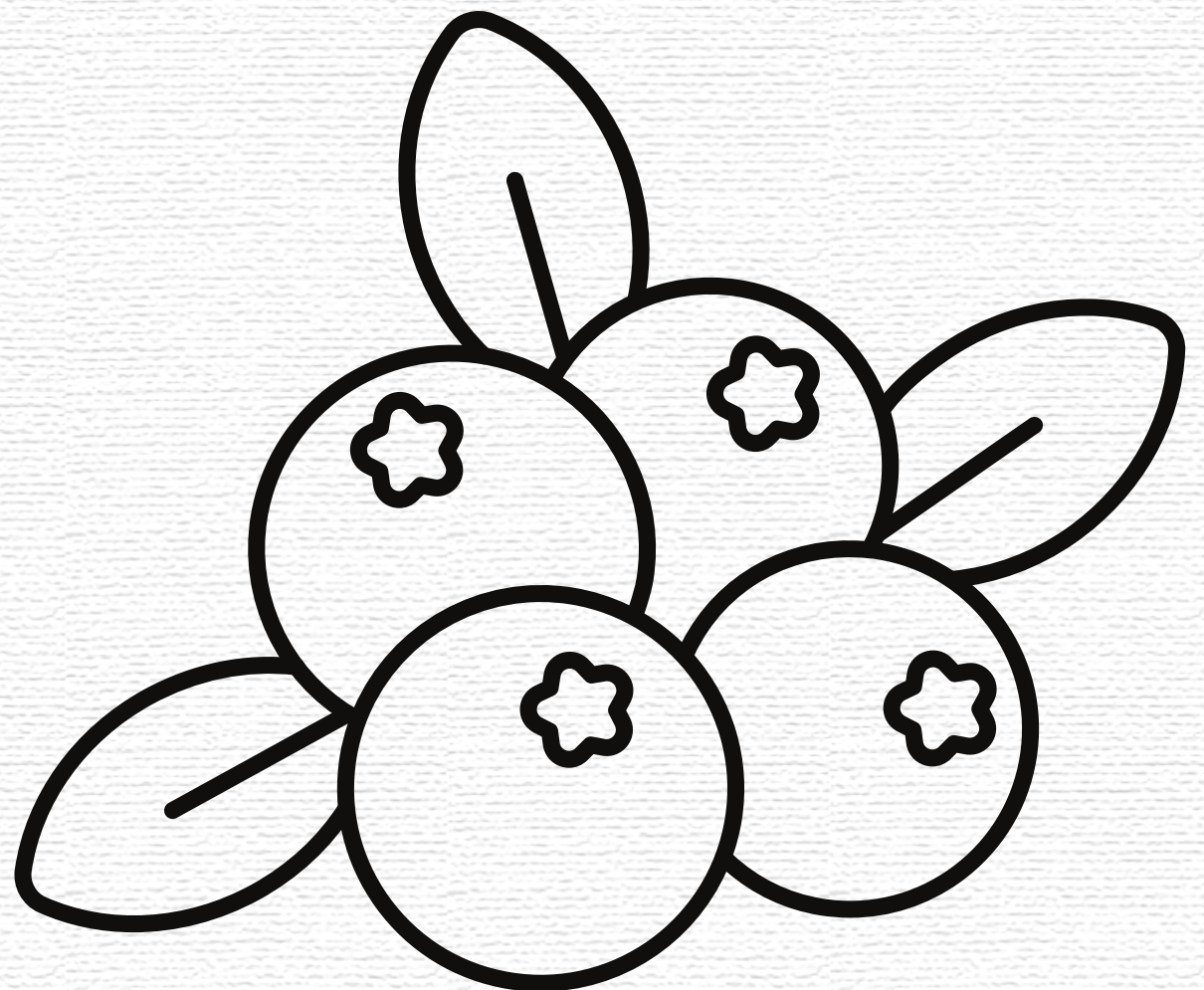
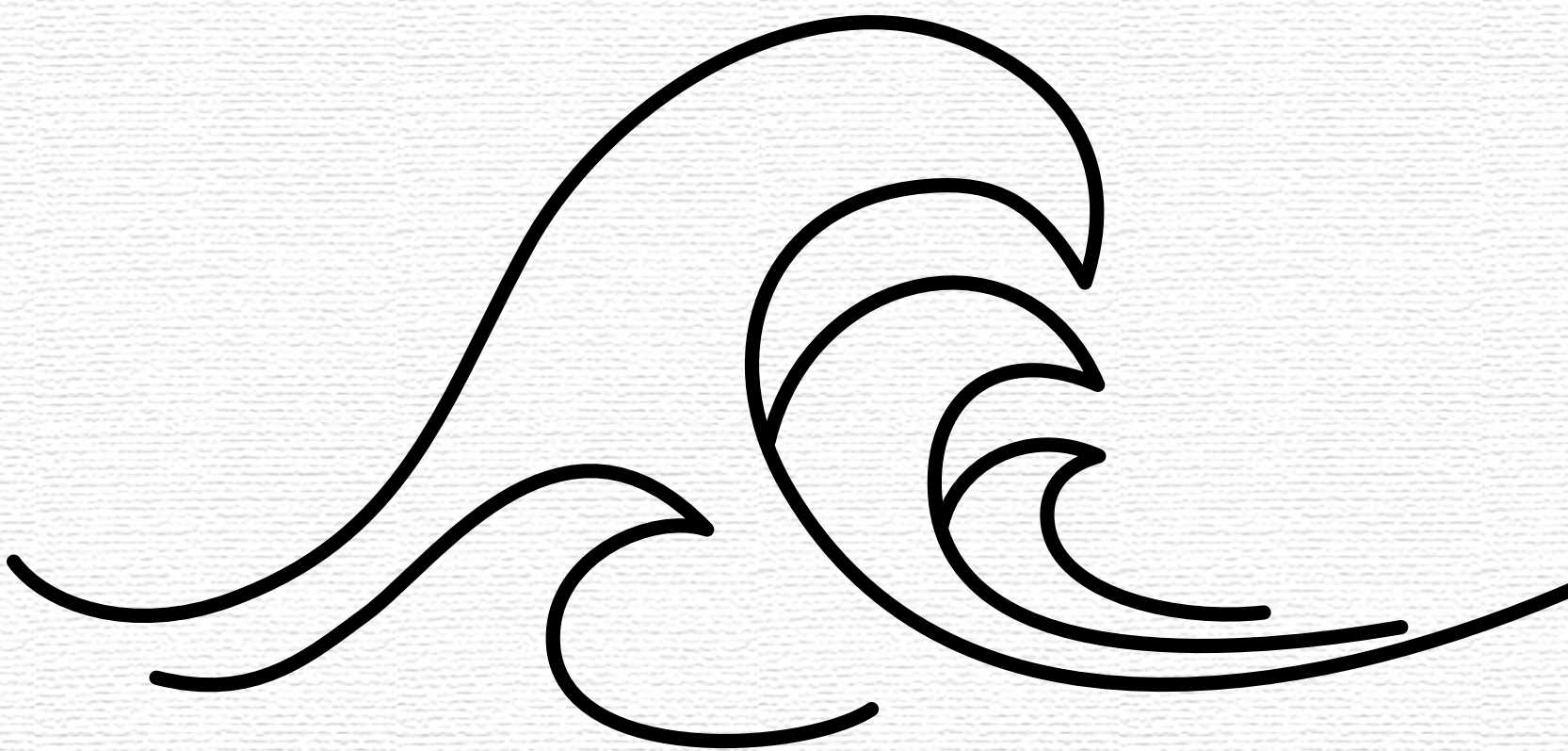
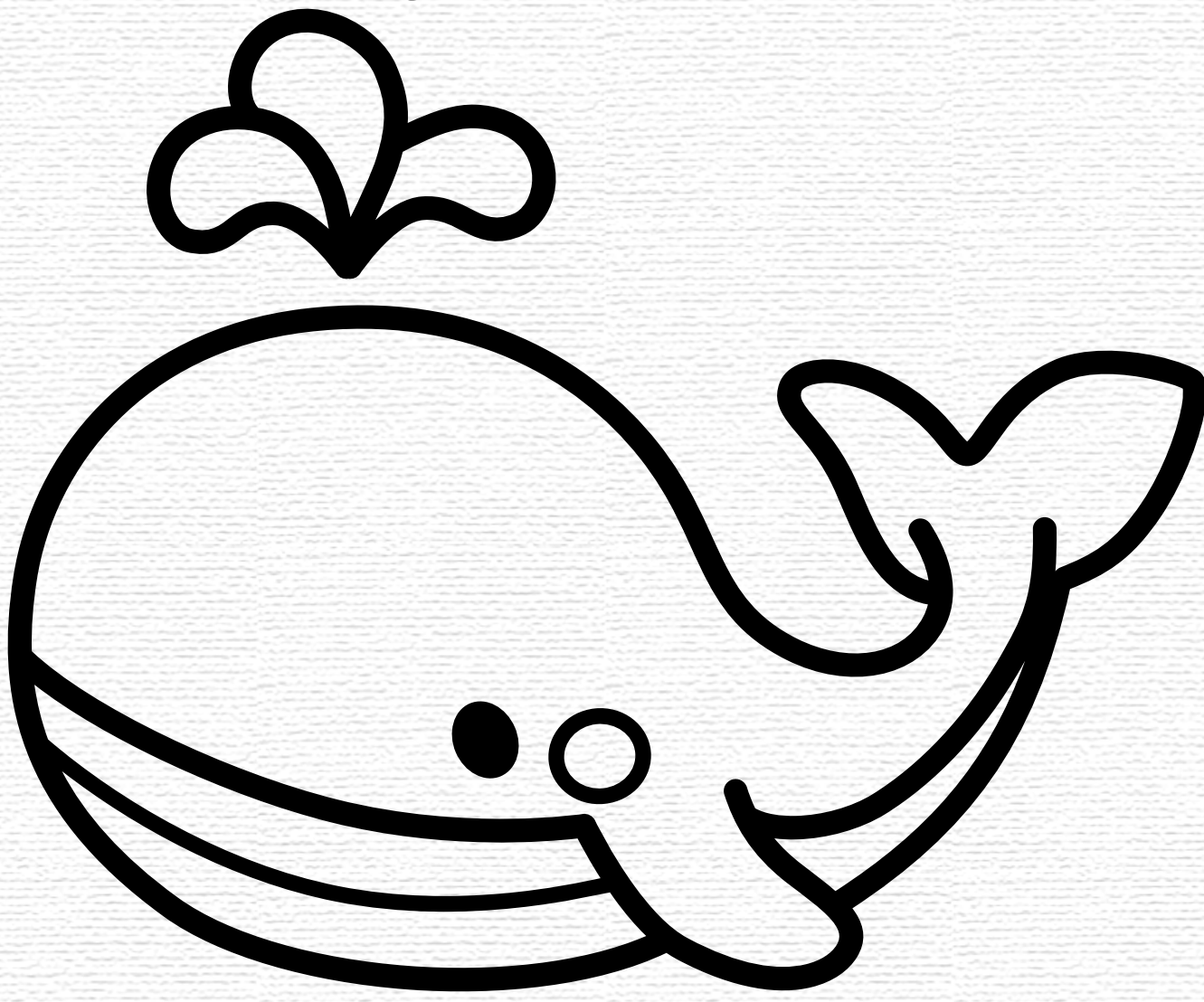

Things that are color **BLACK**

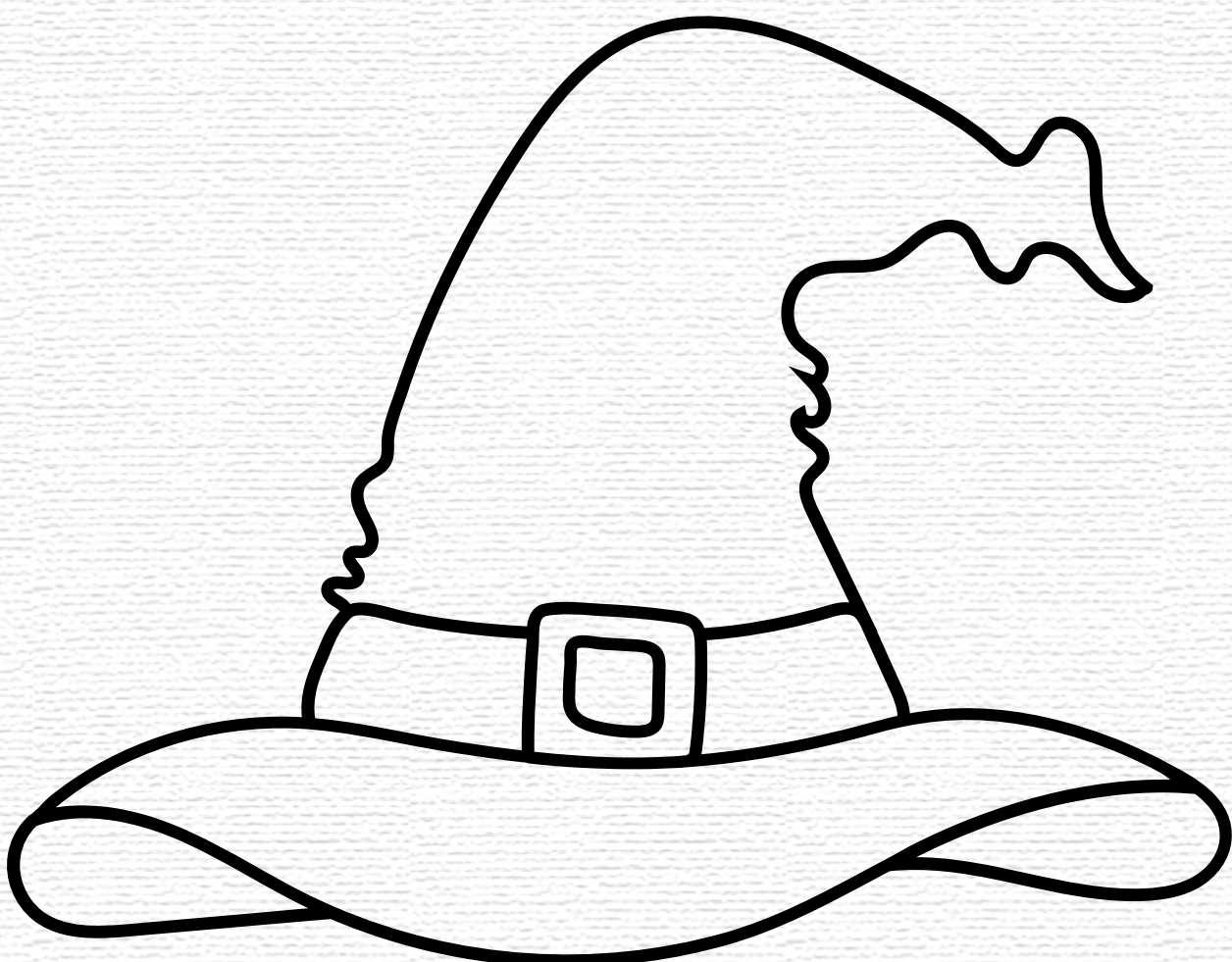
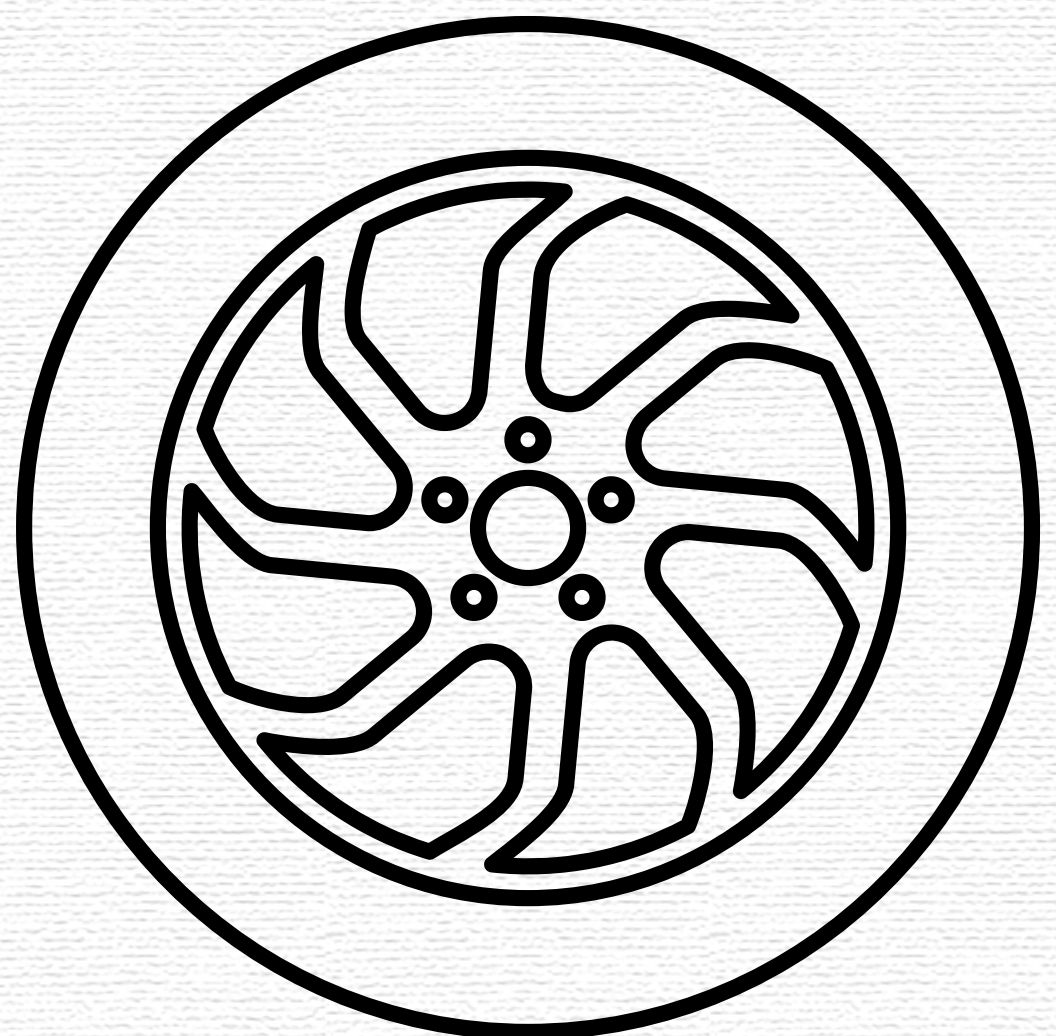
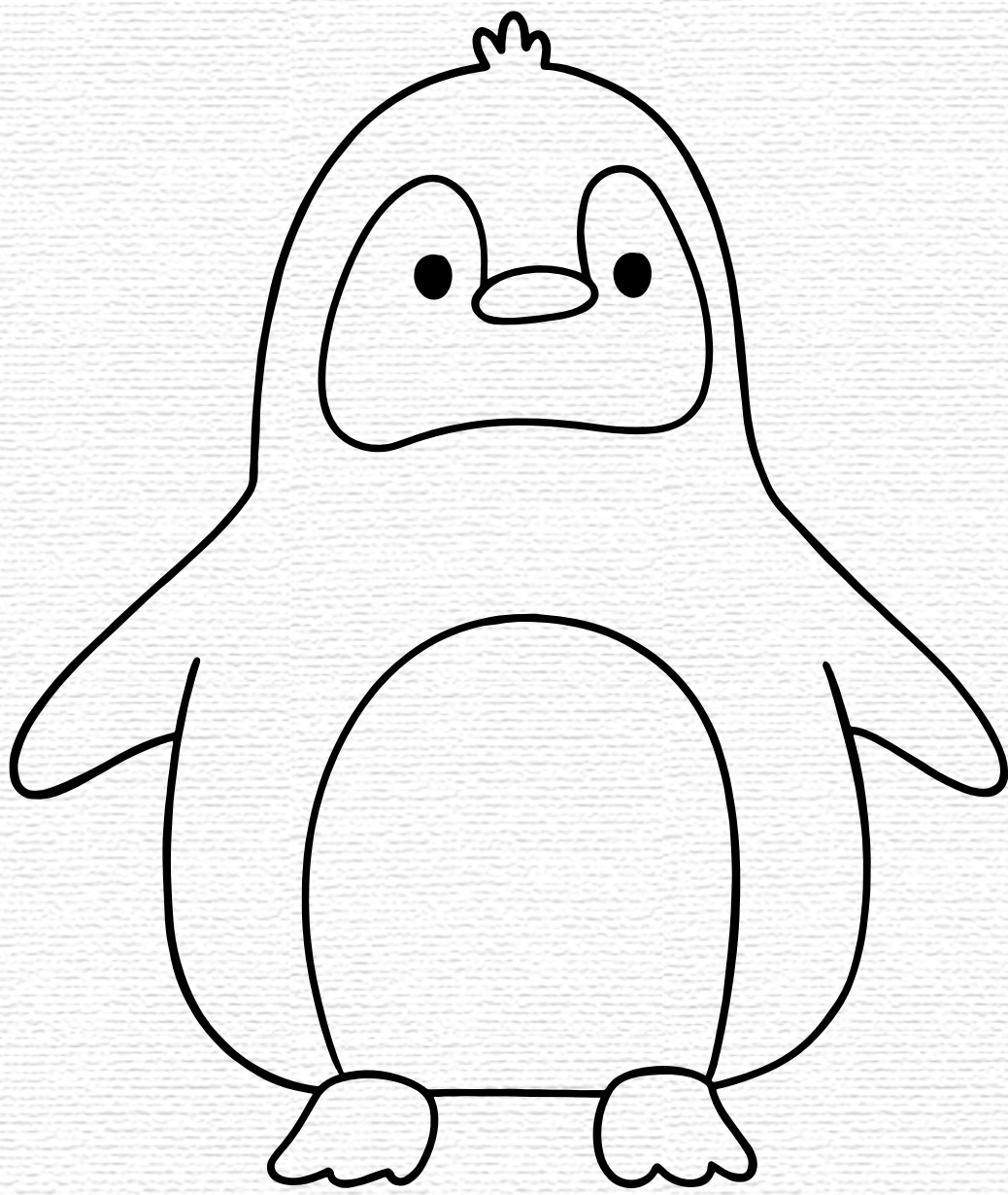
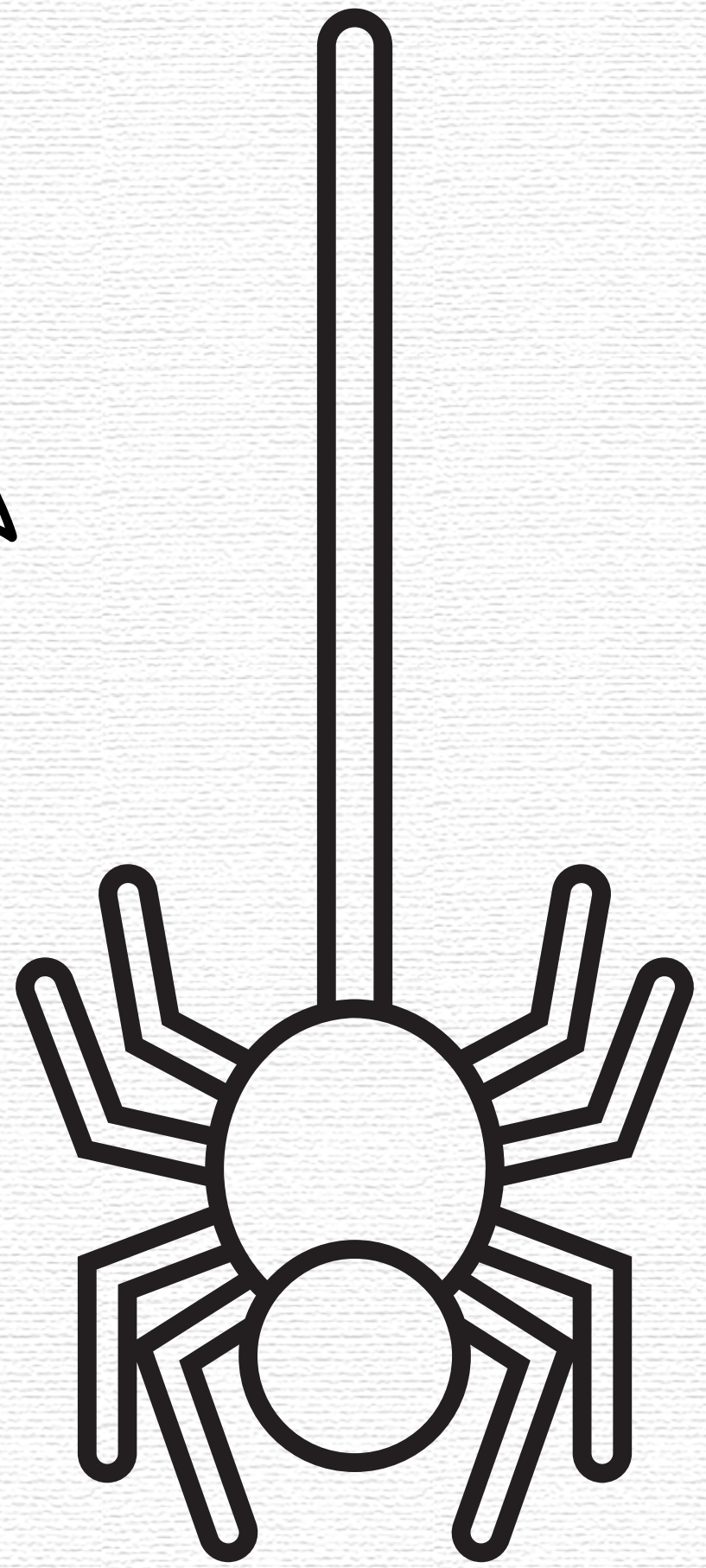
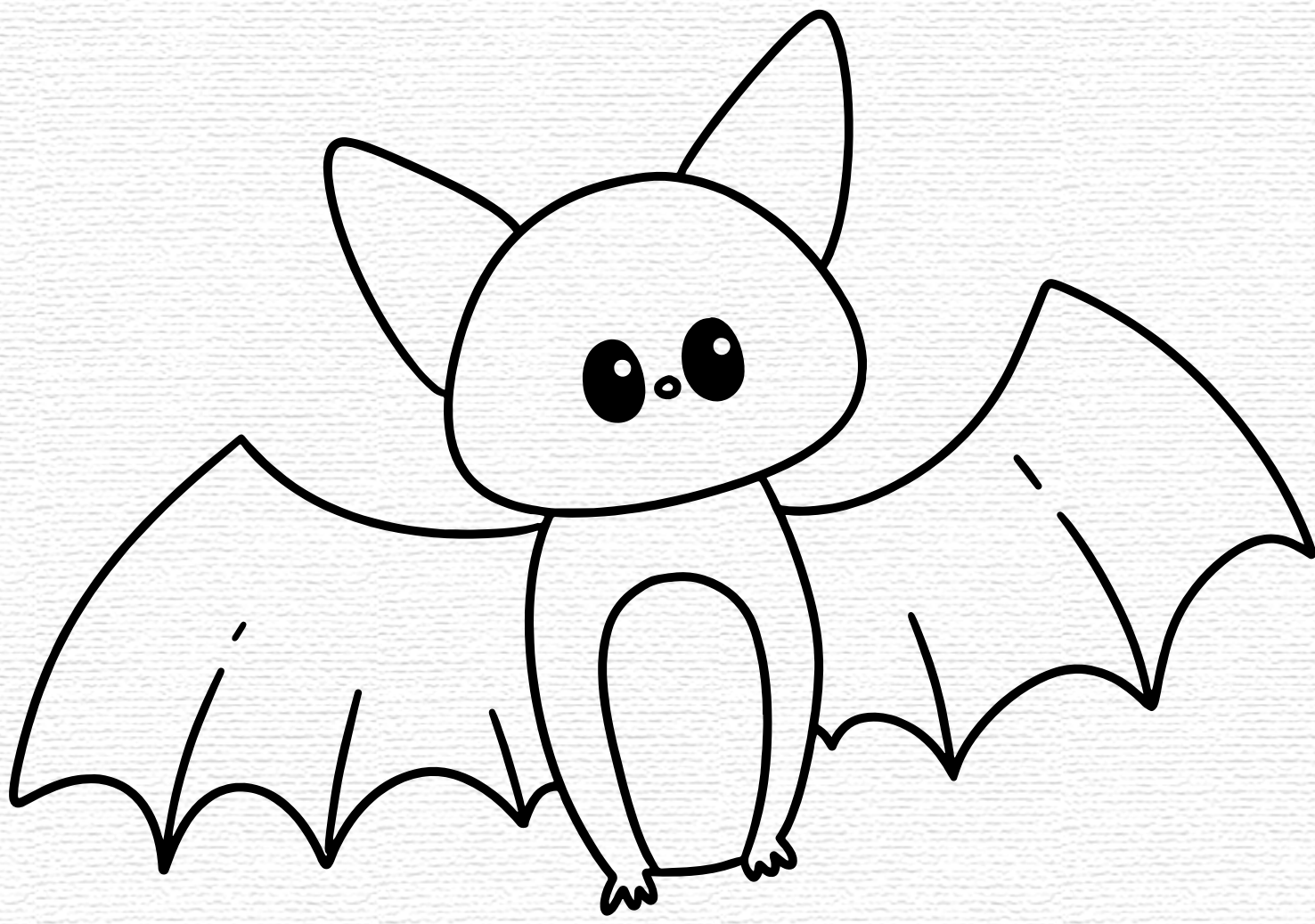

Numbers



Trace the words

1

one

one

2

two

two

3

three

three

4

four

four

5

five

five

6

six

six

7

seven

seven

8

eight

eight

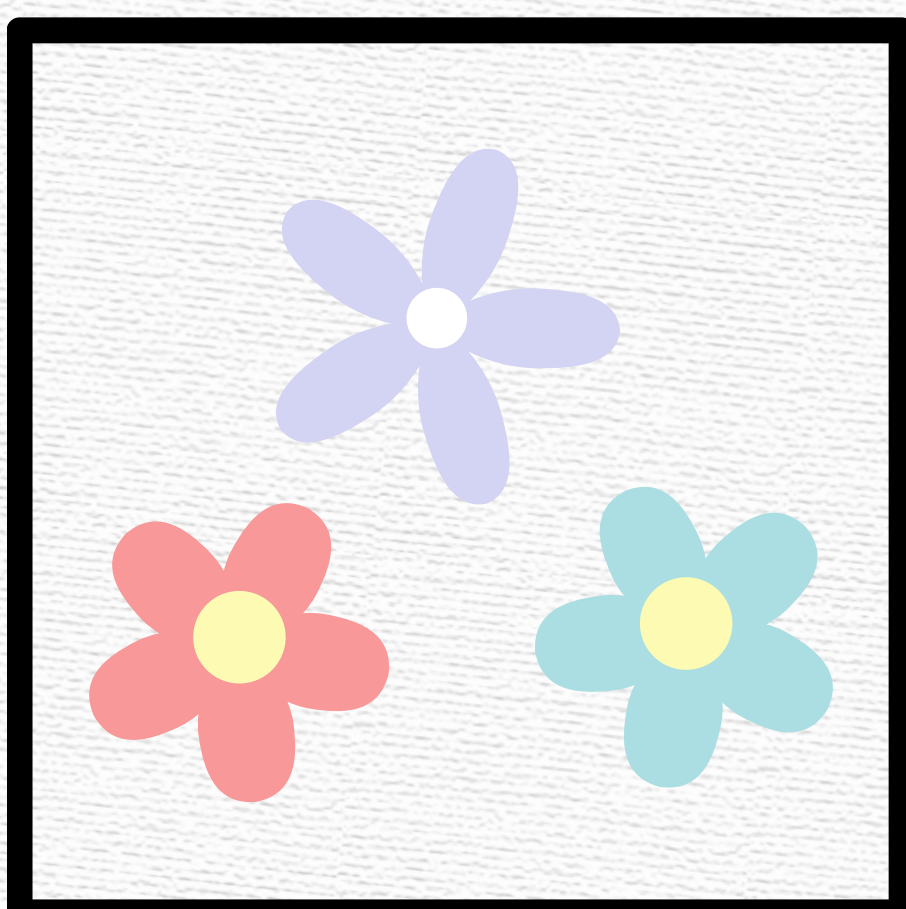
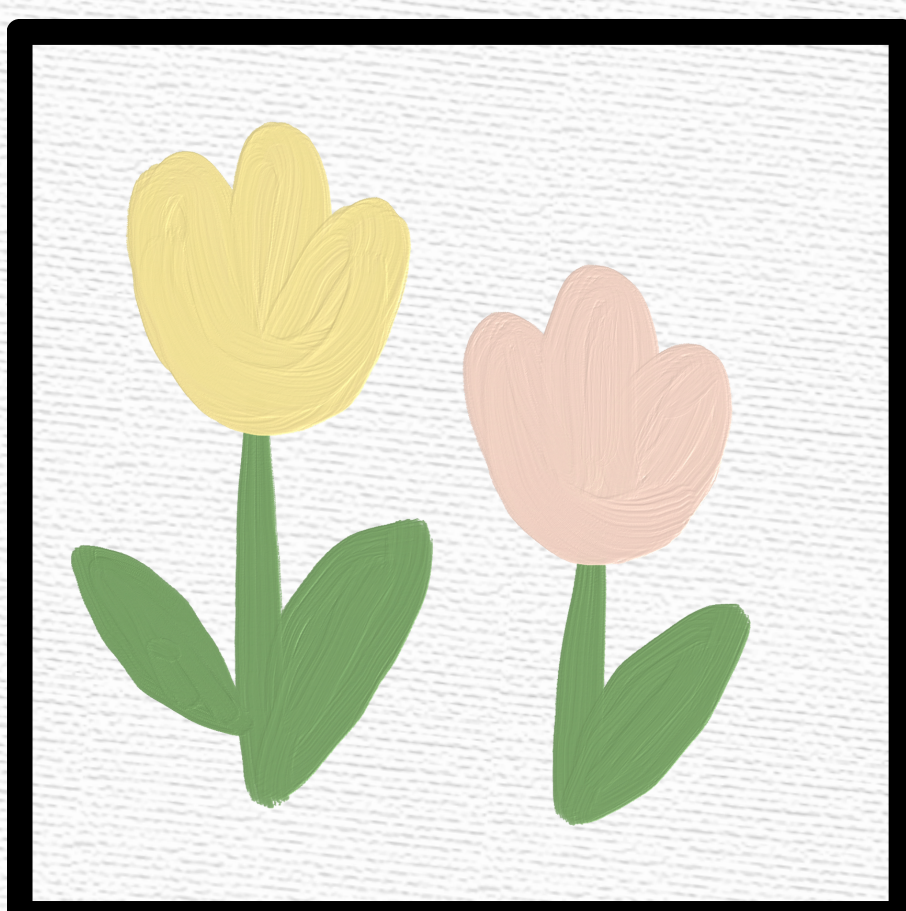
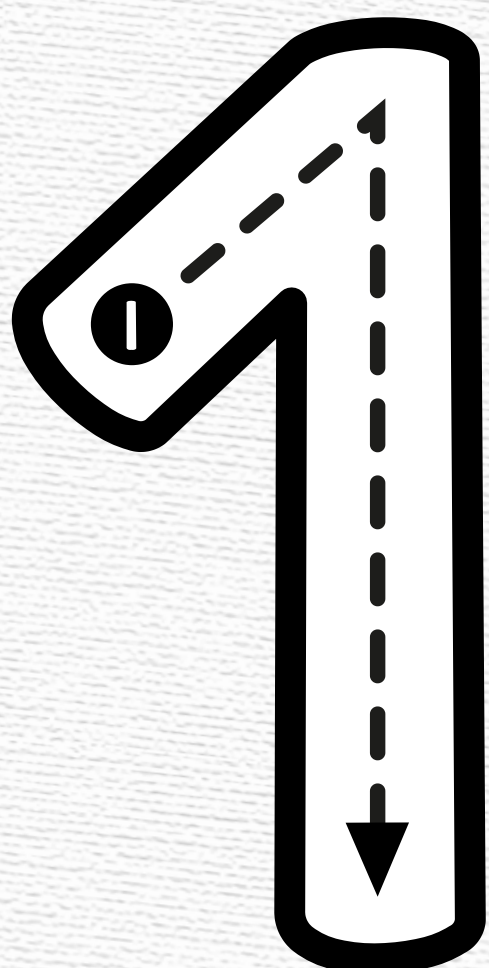

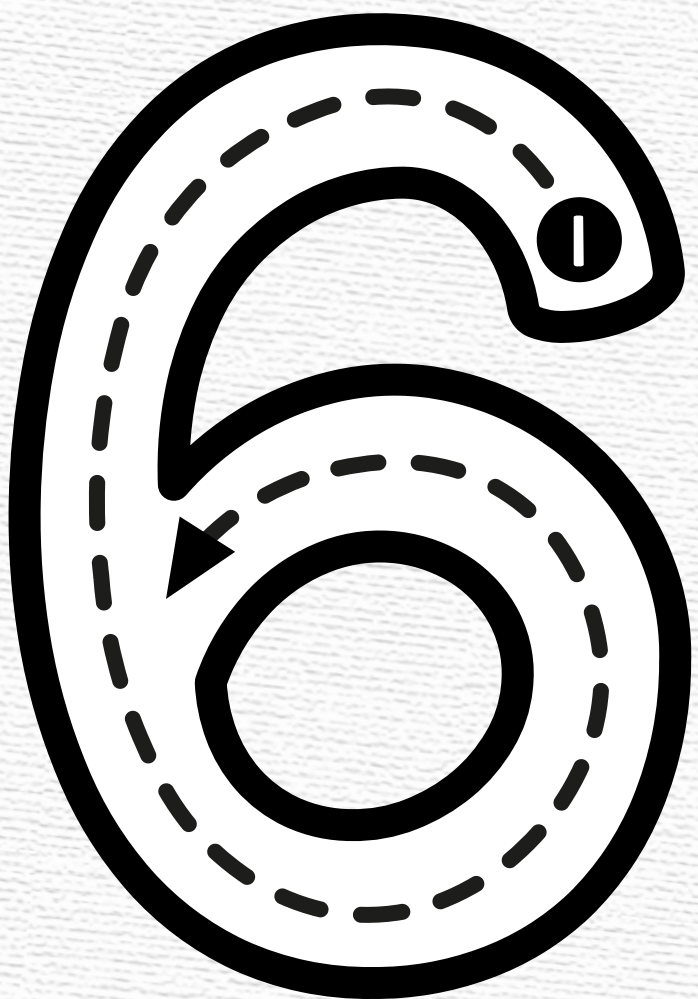
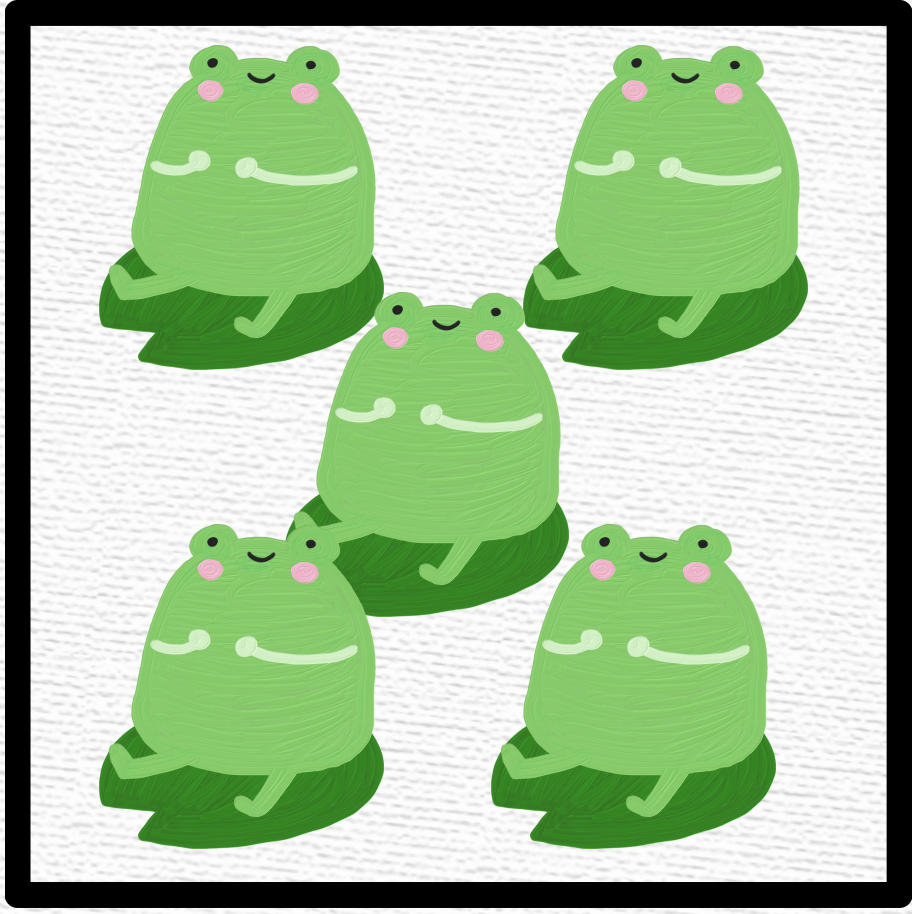
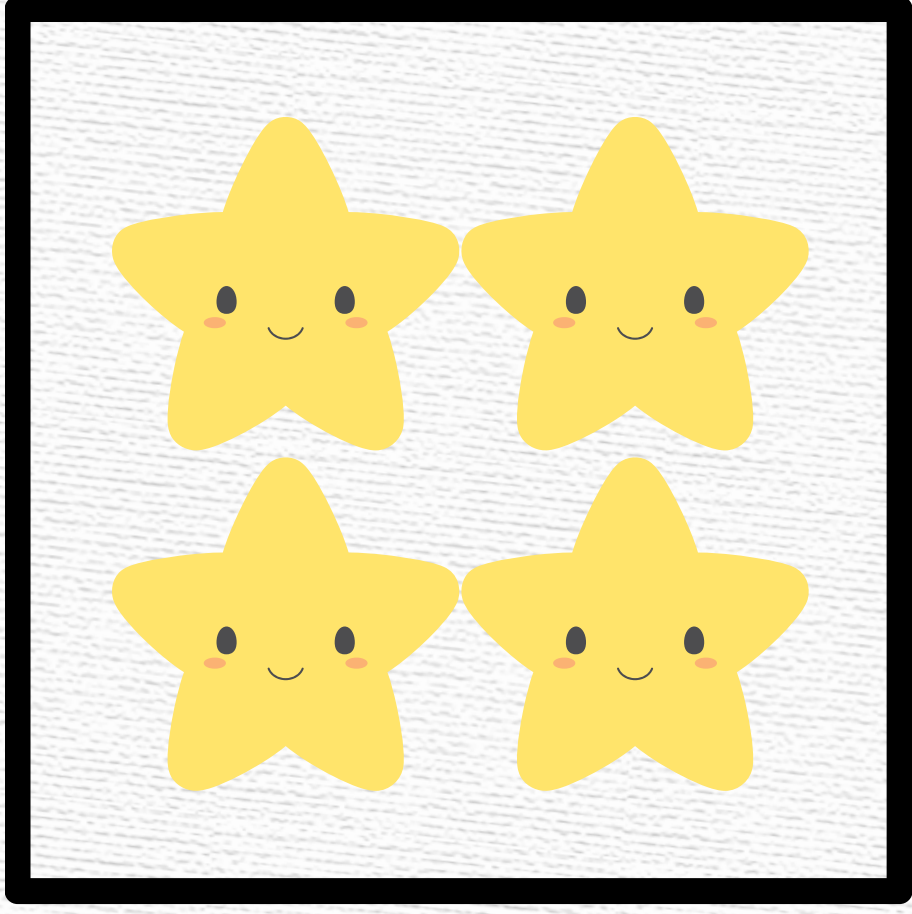
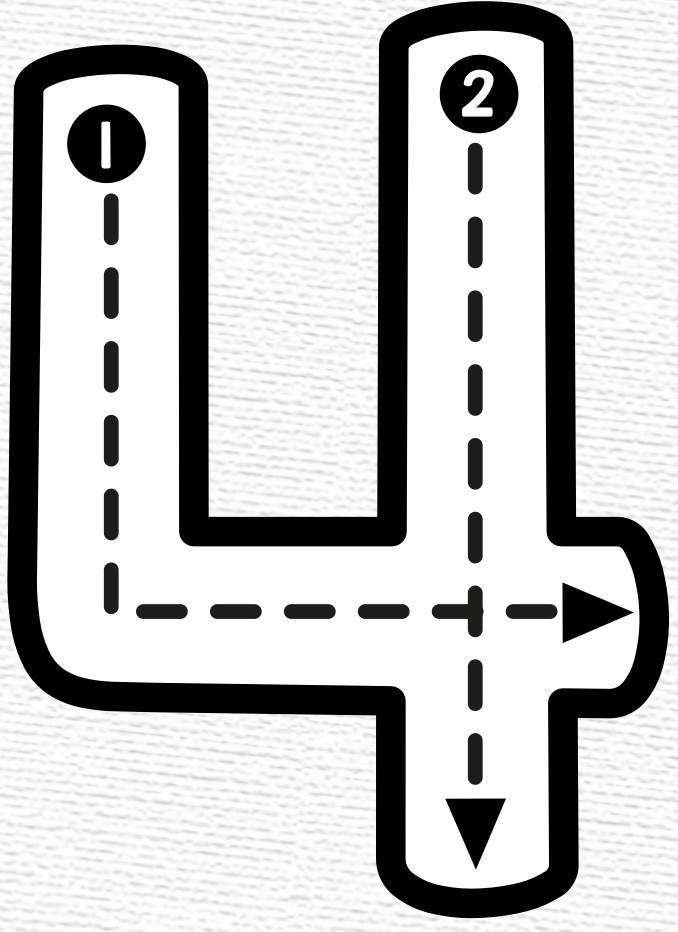

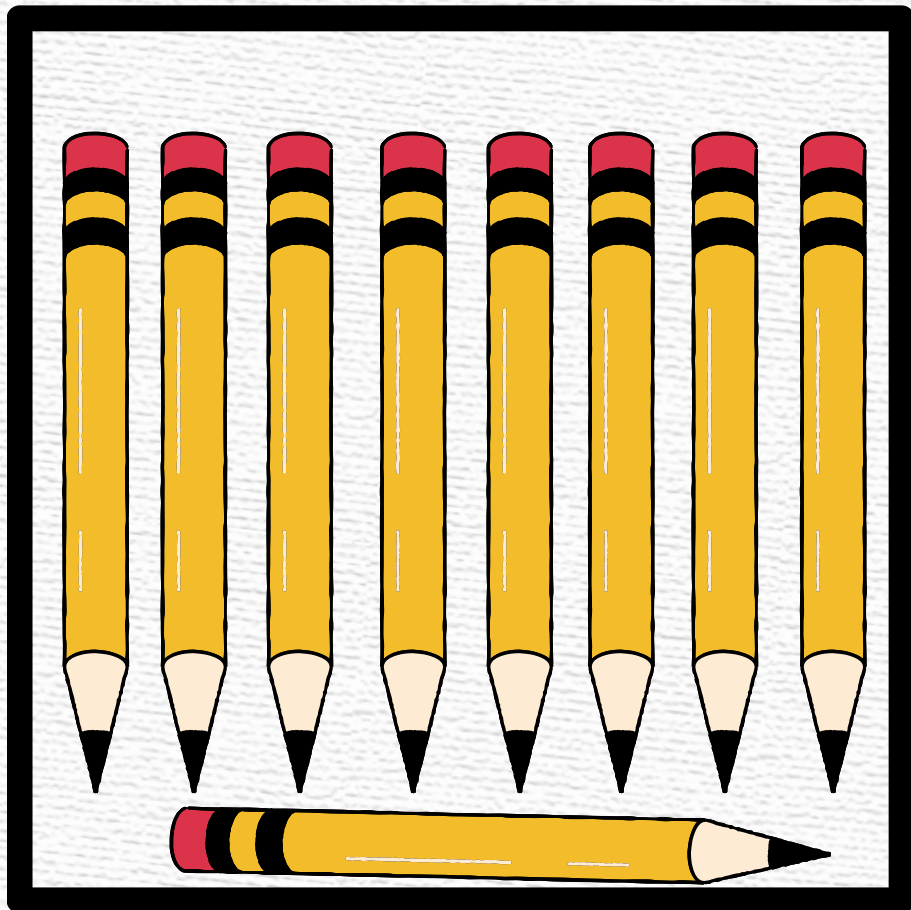
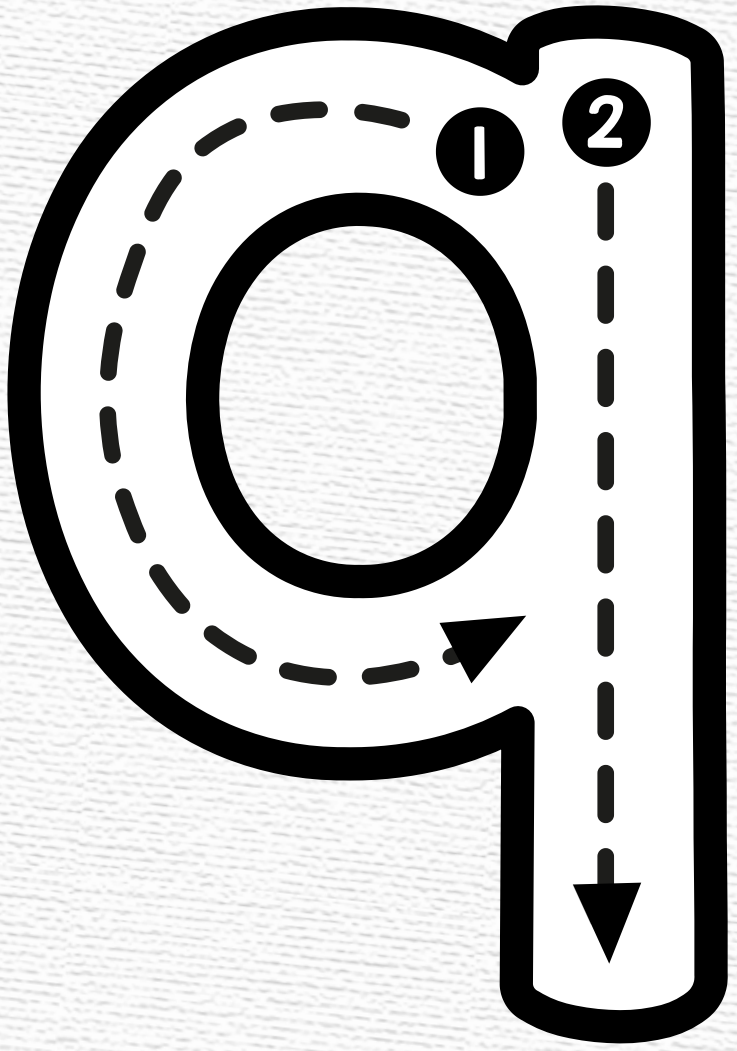
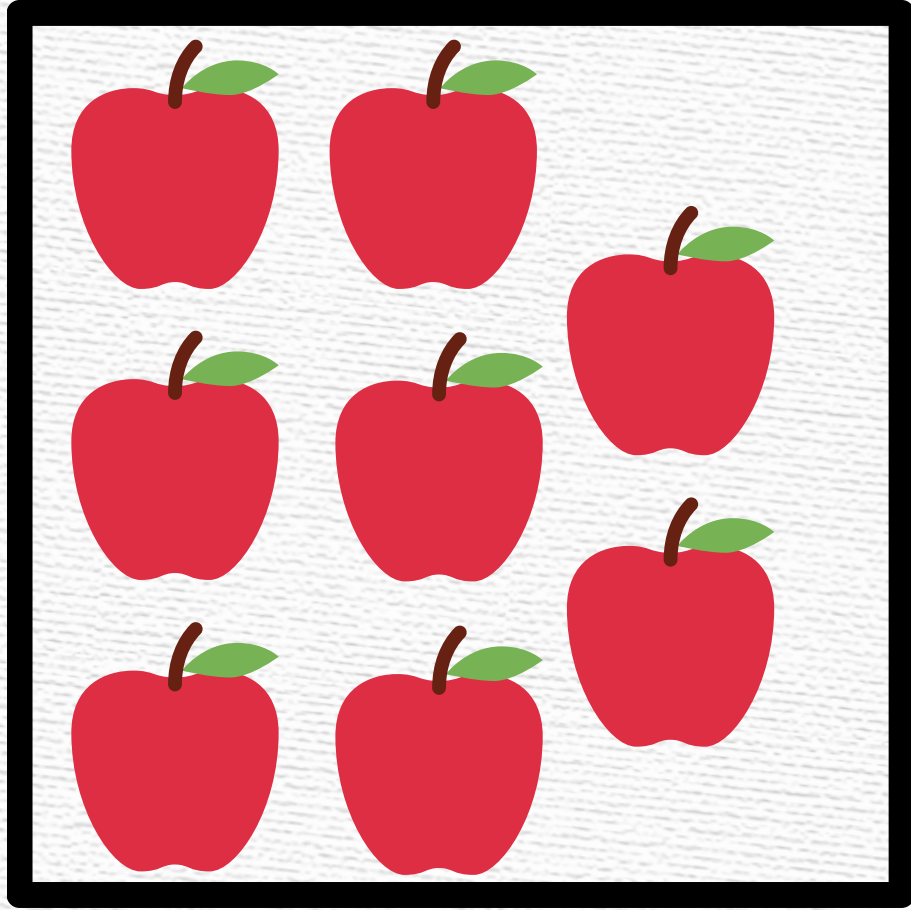
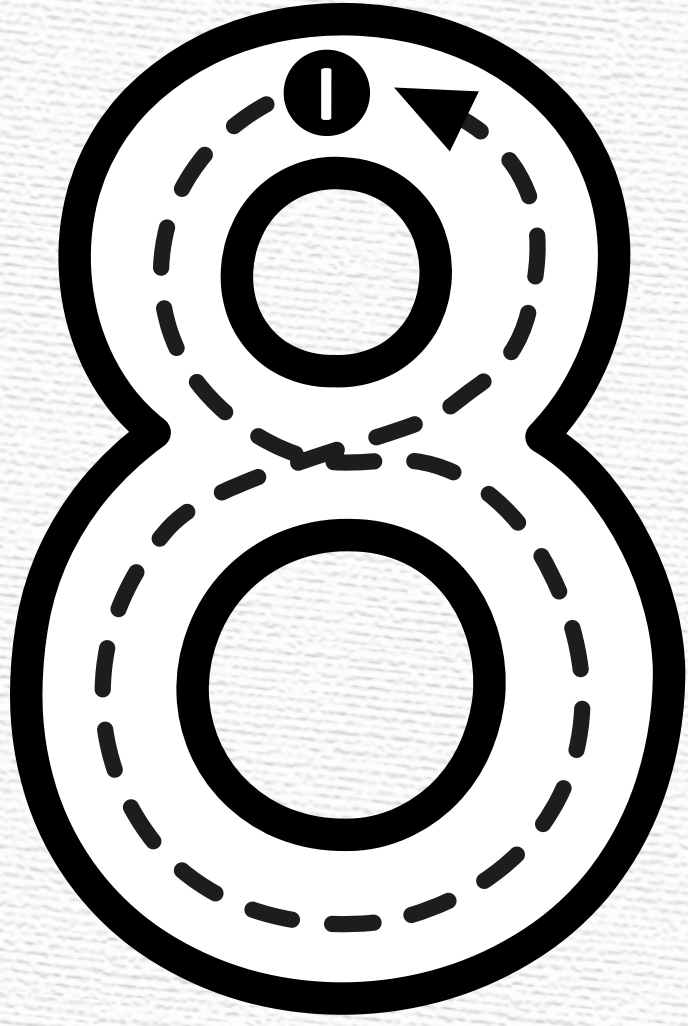
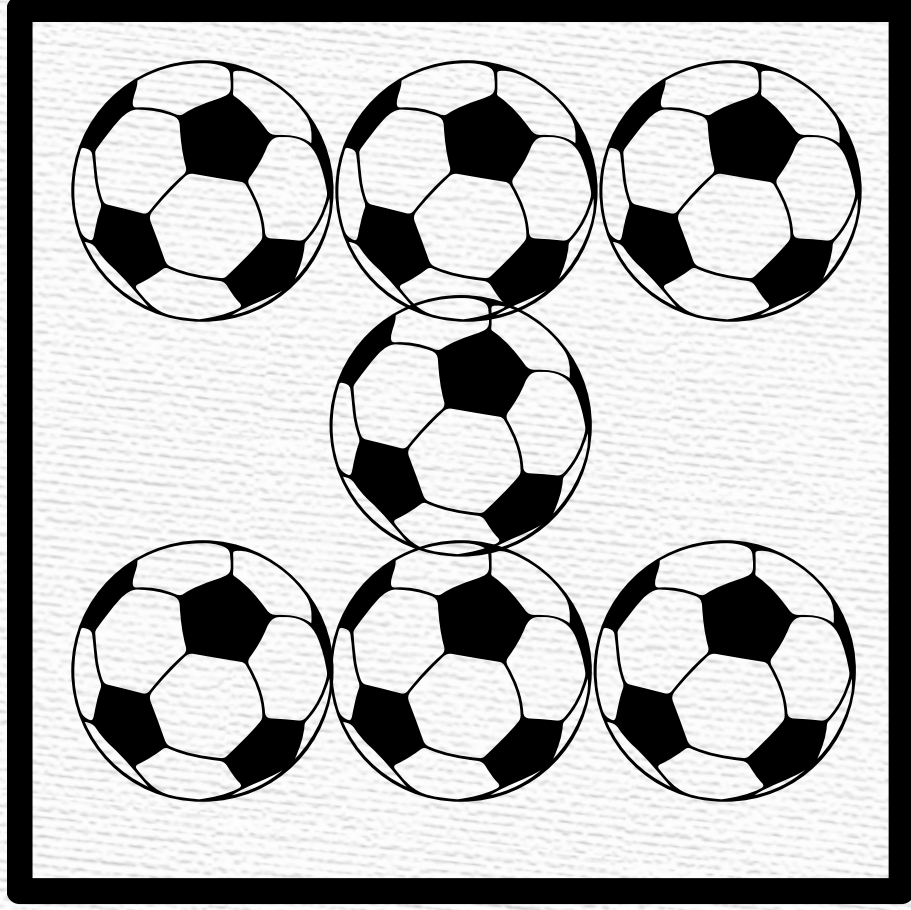

Shade the box that matches the numbers













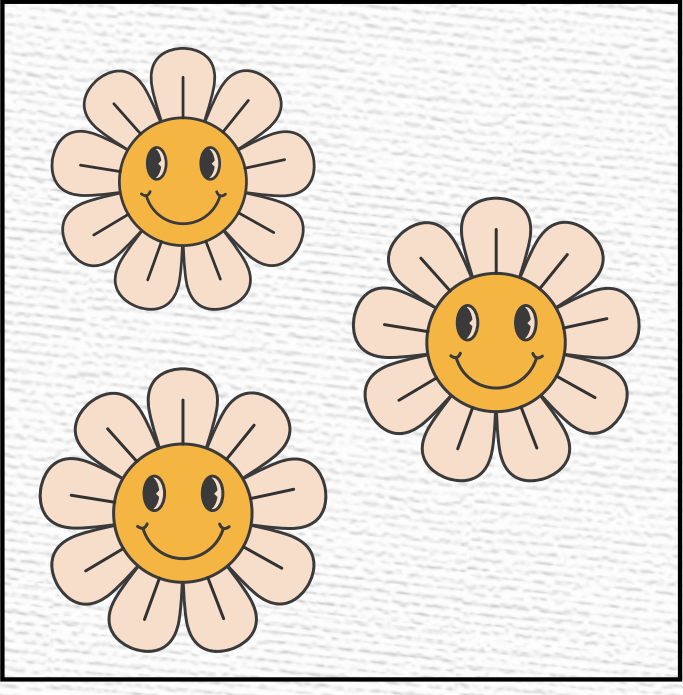

•

•

3

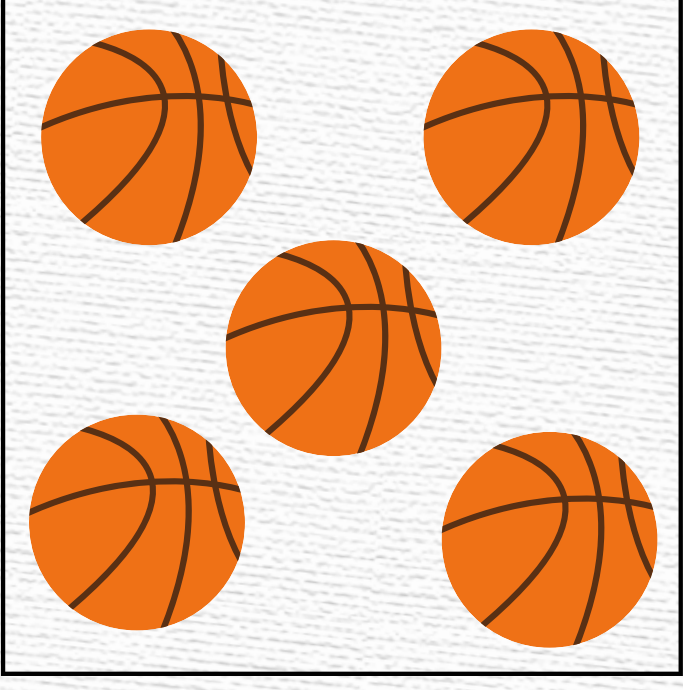

•

•

1

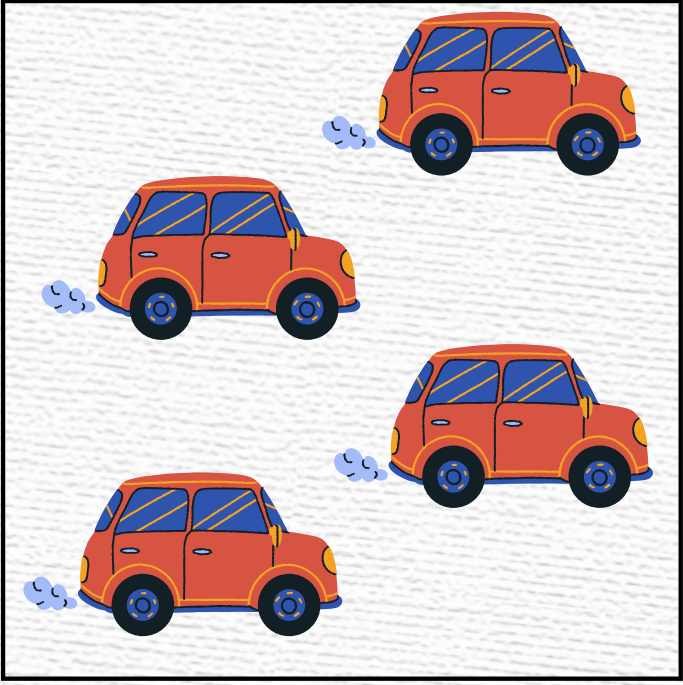

•

•

2



•

•

5

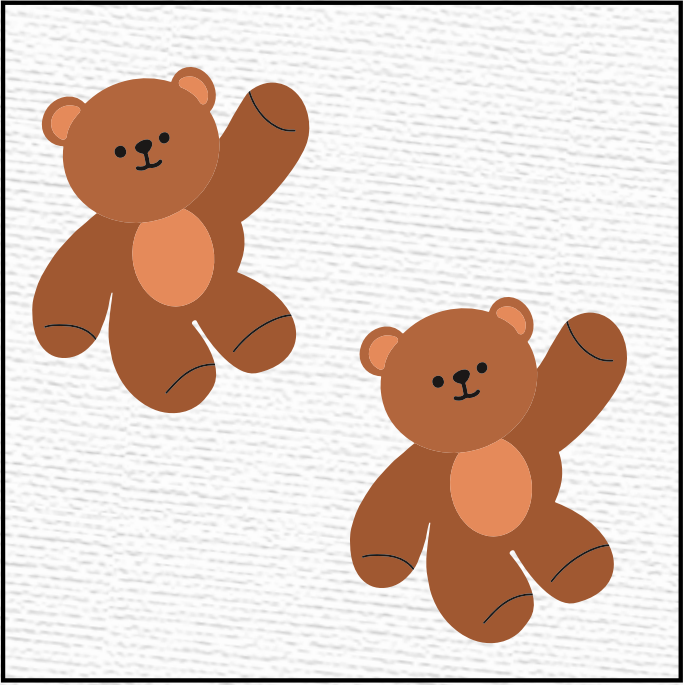

•

•

4

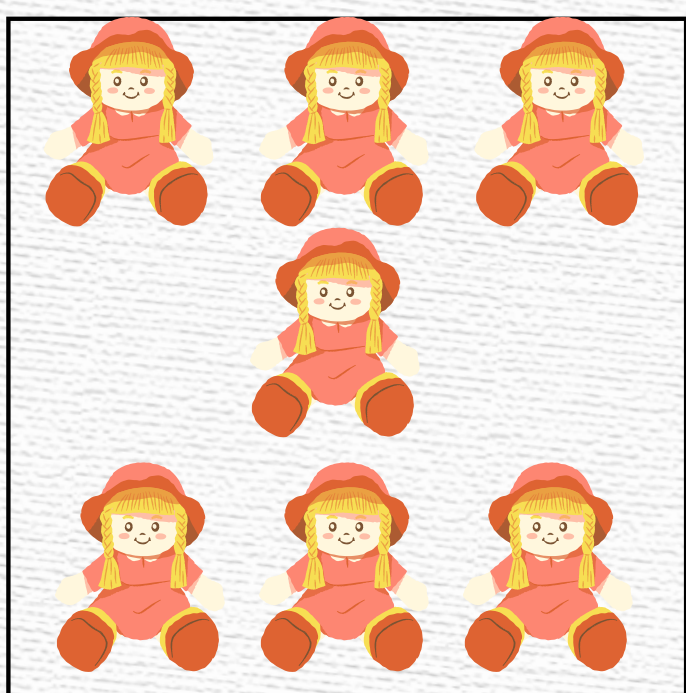

•

• 6

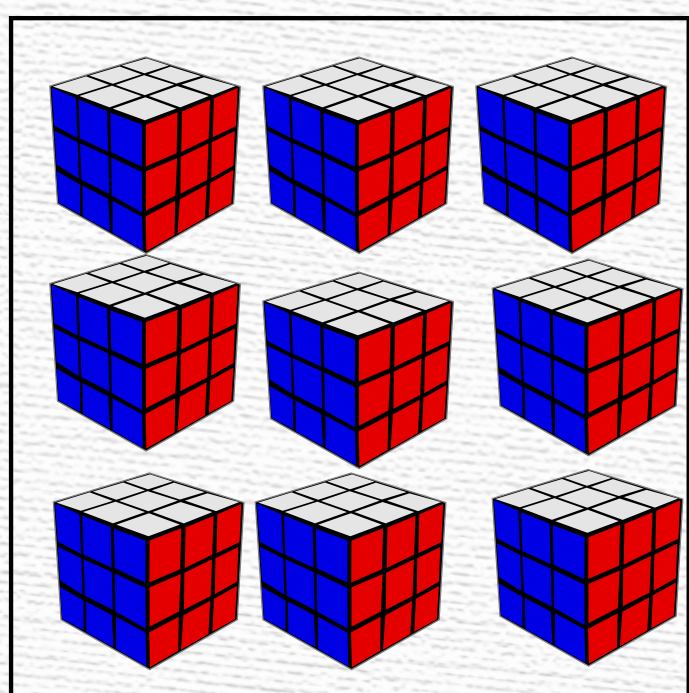

•

• 10

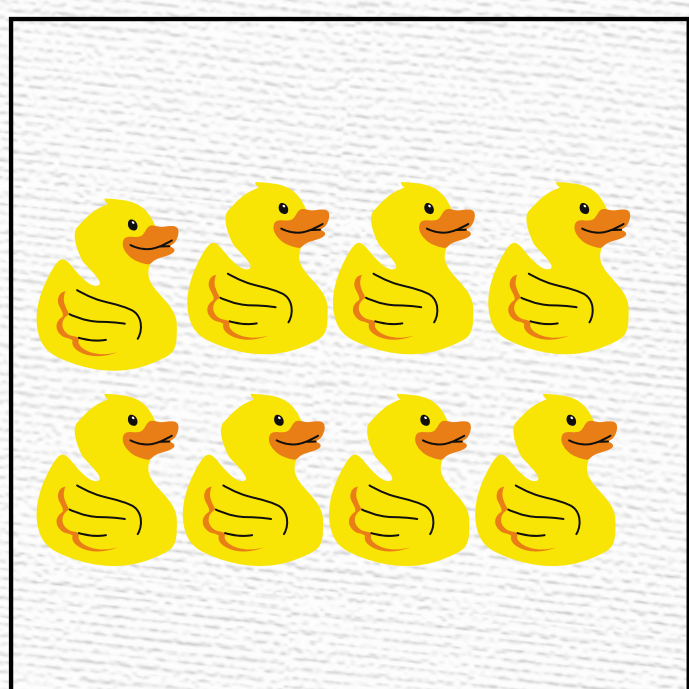

•

• 9



•

• 8

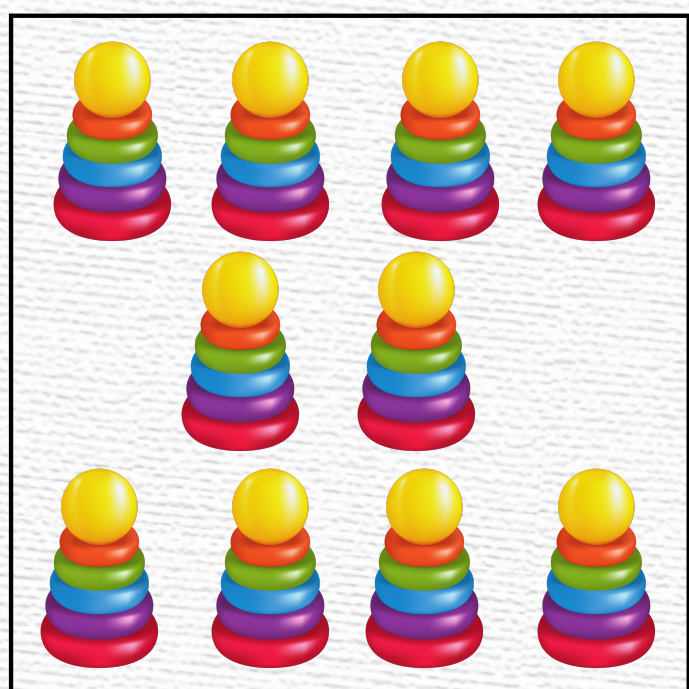

•

• 7

Shapes



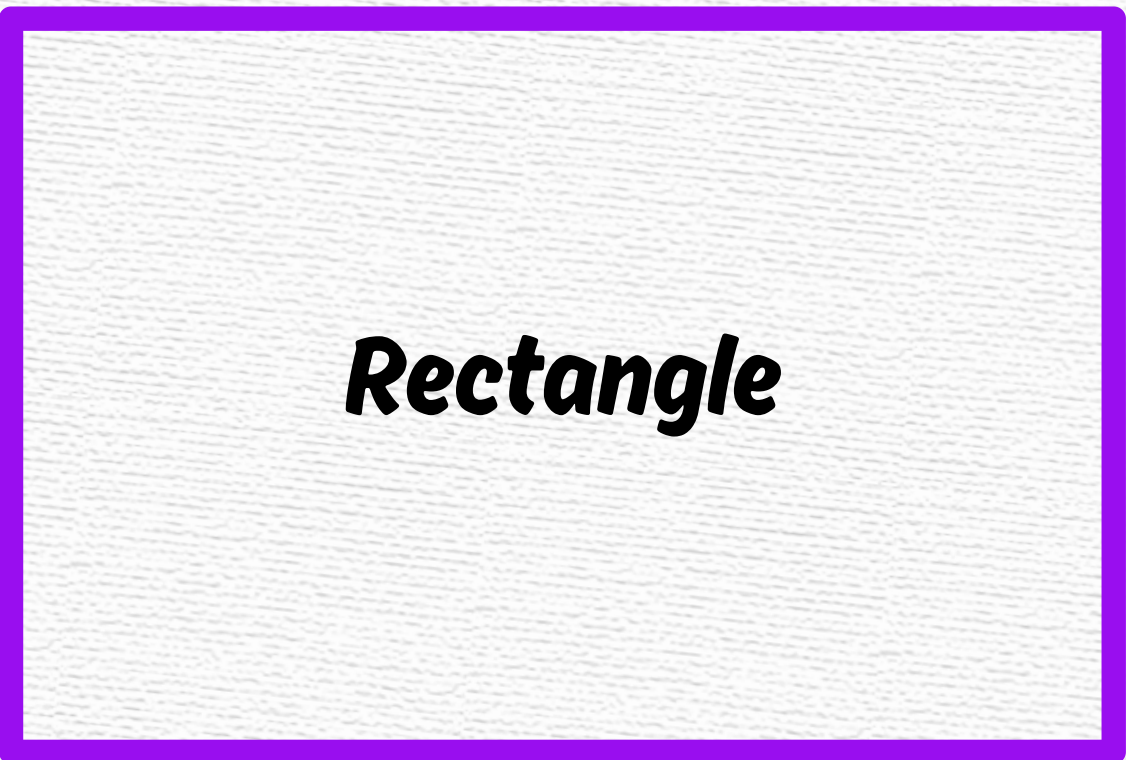
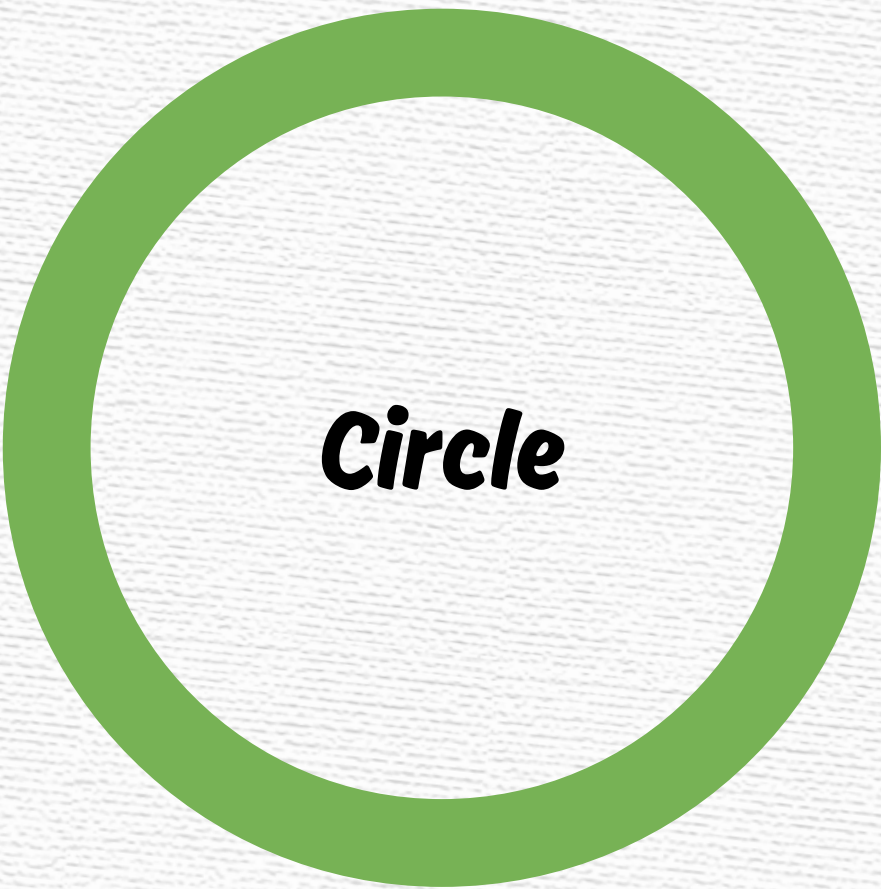
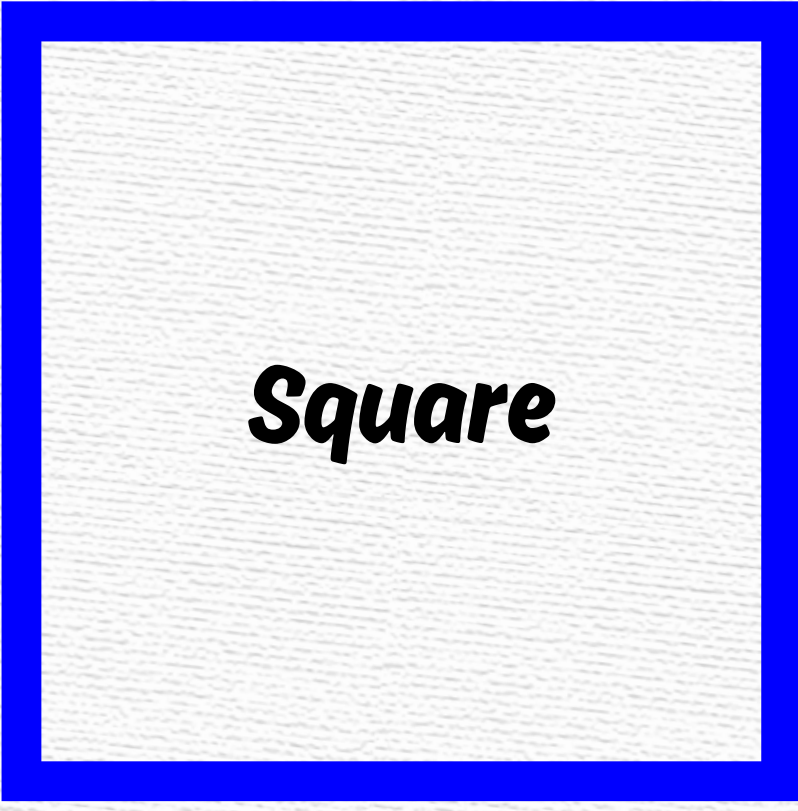
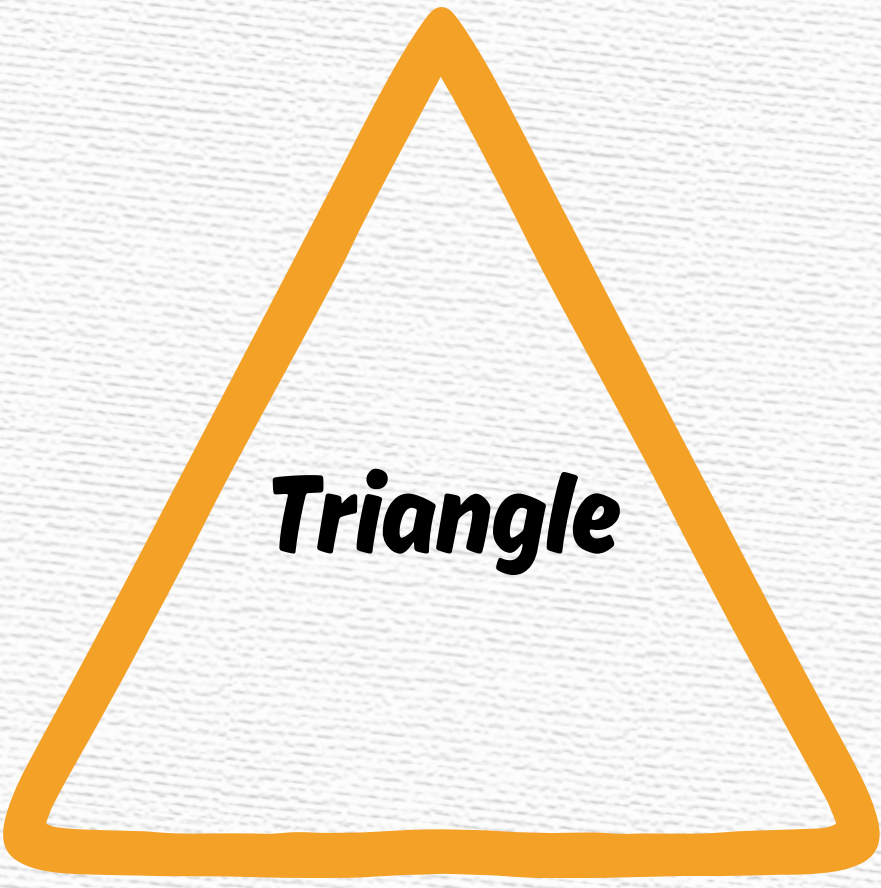

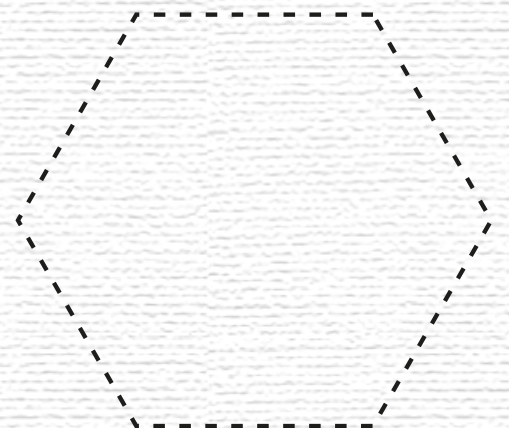
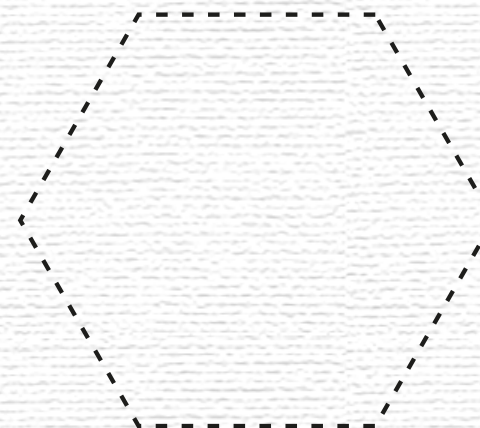
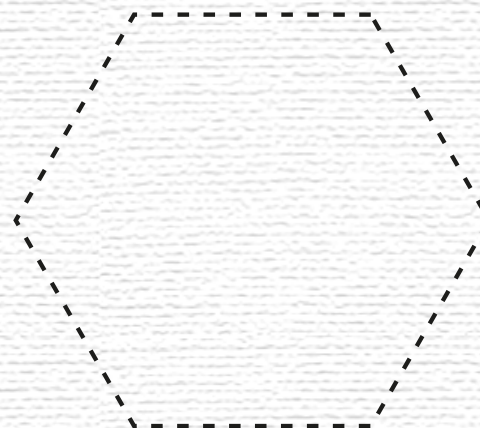
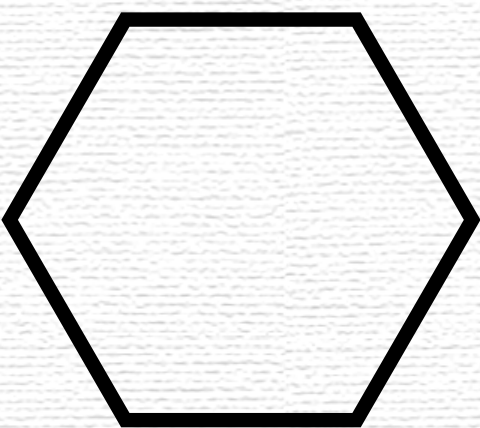
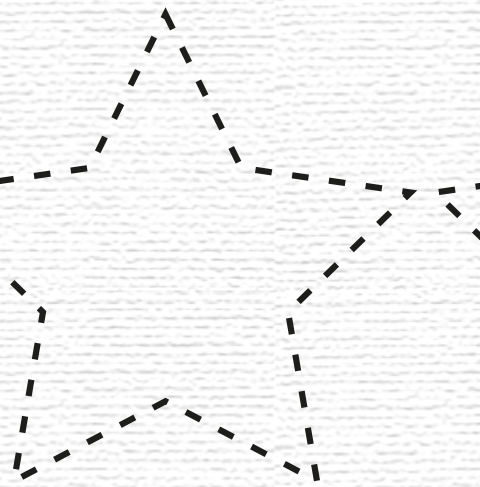
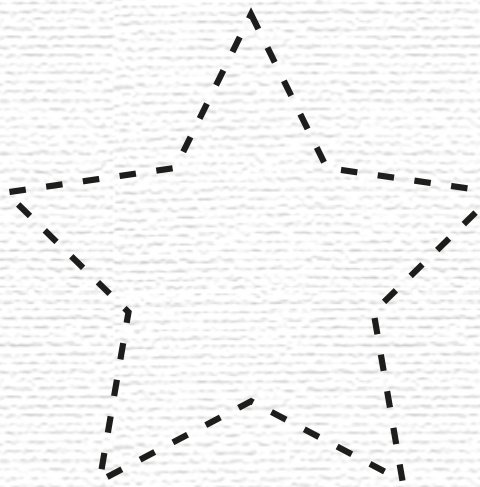
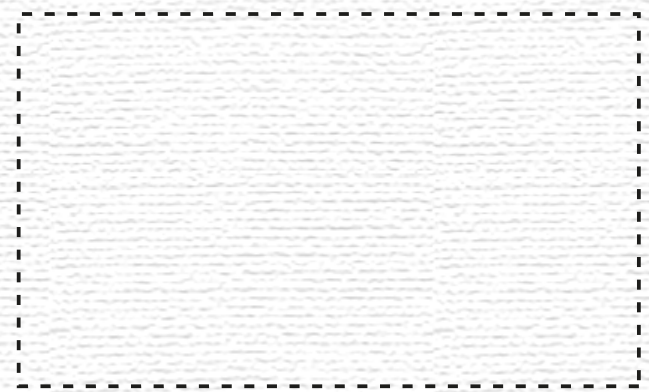
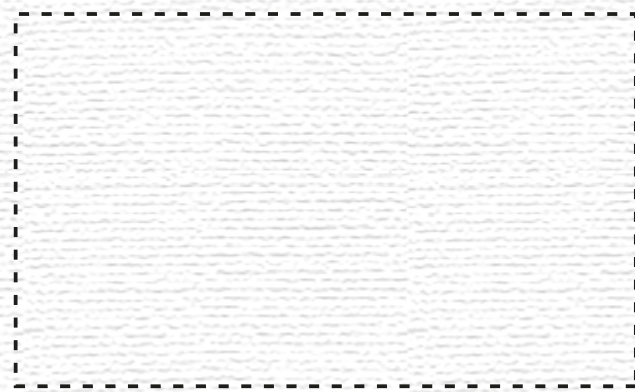
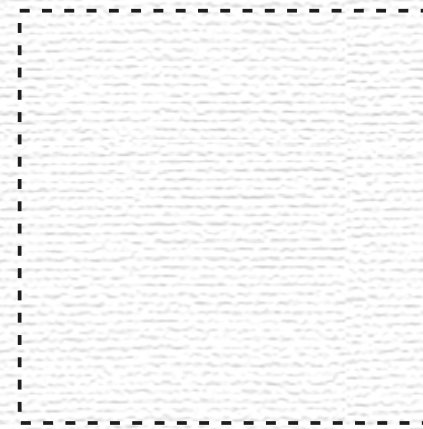
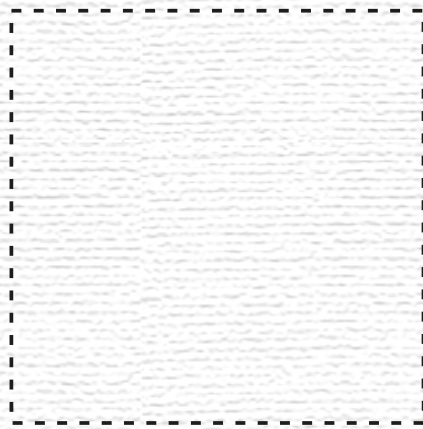
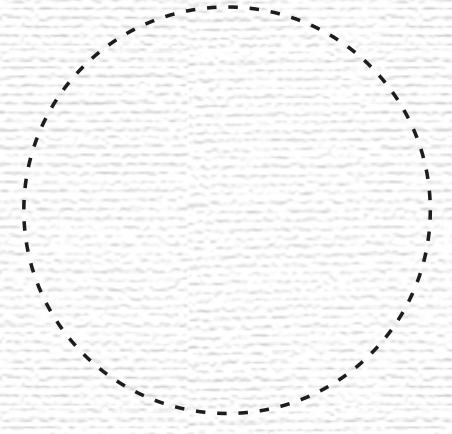
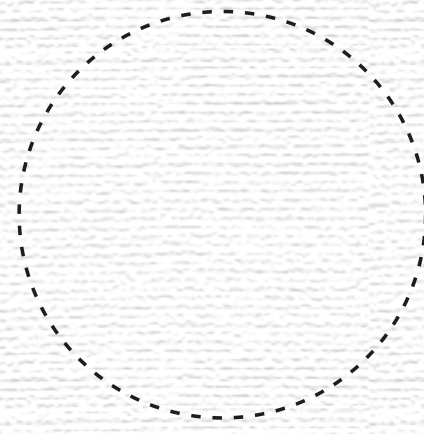
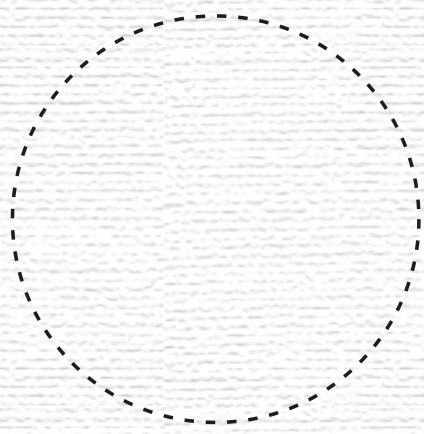
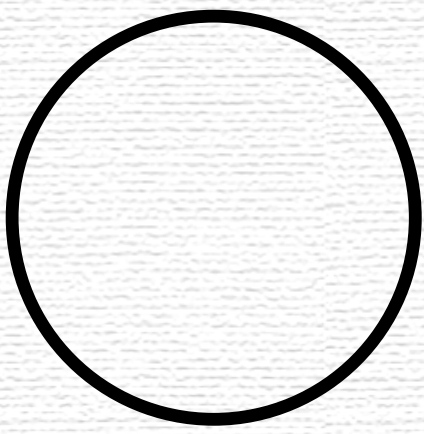
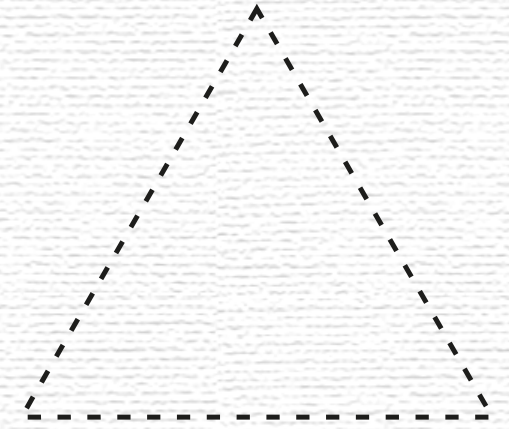
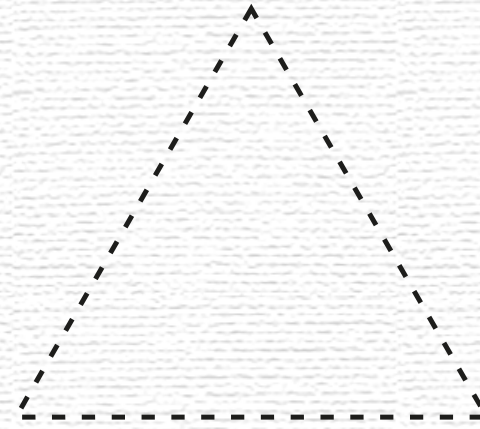
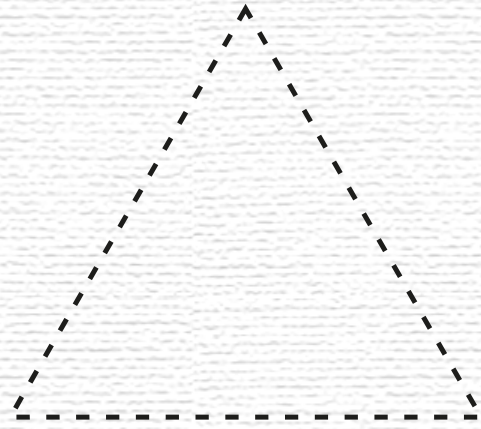
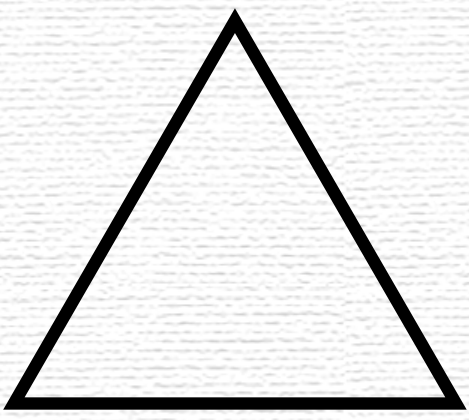

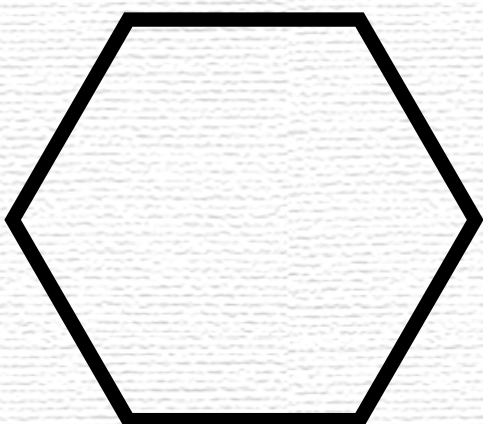
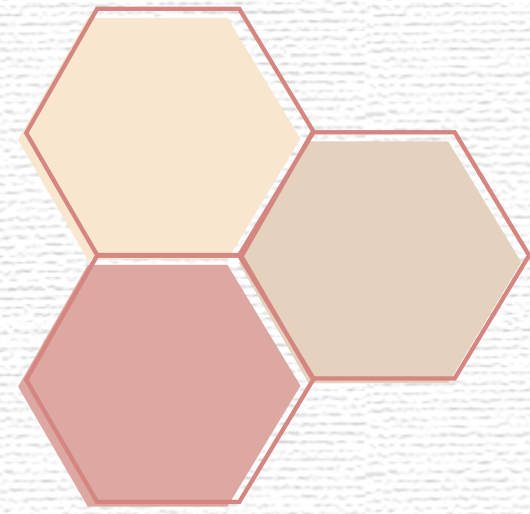
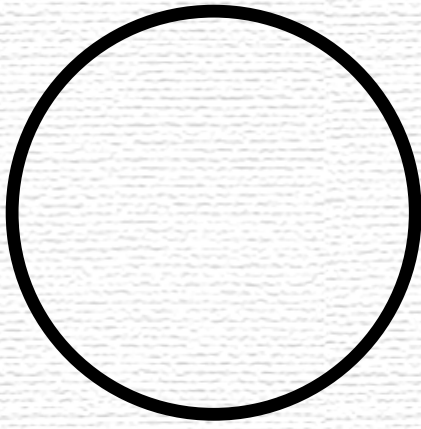
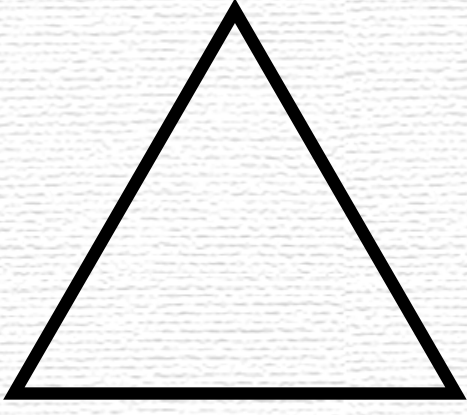

Color the same objects with the same color

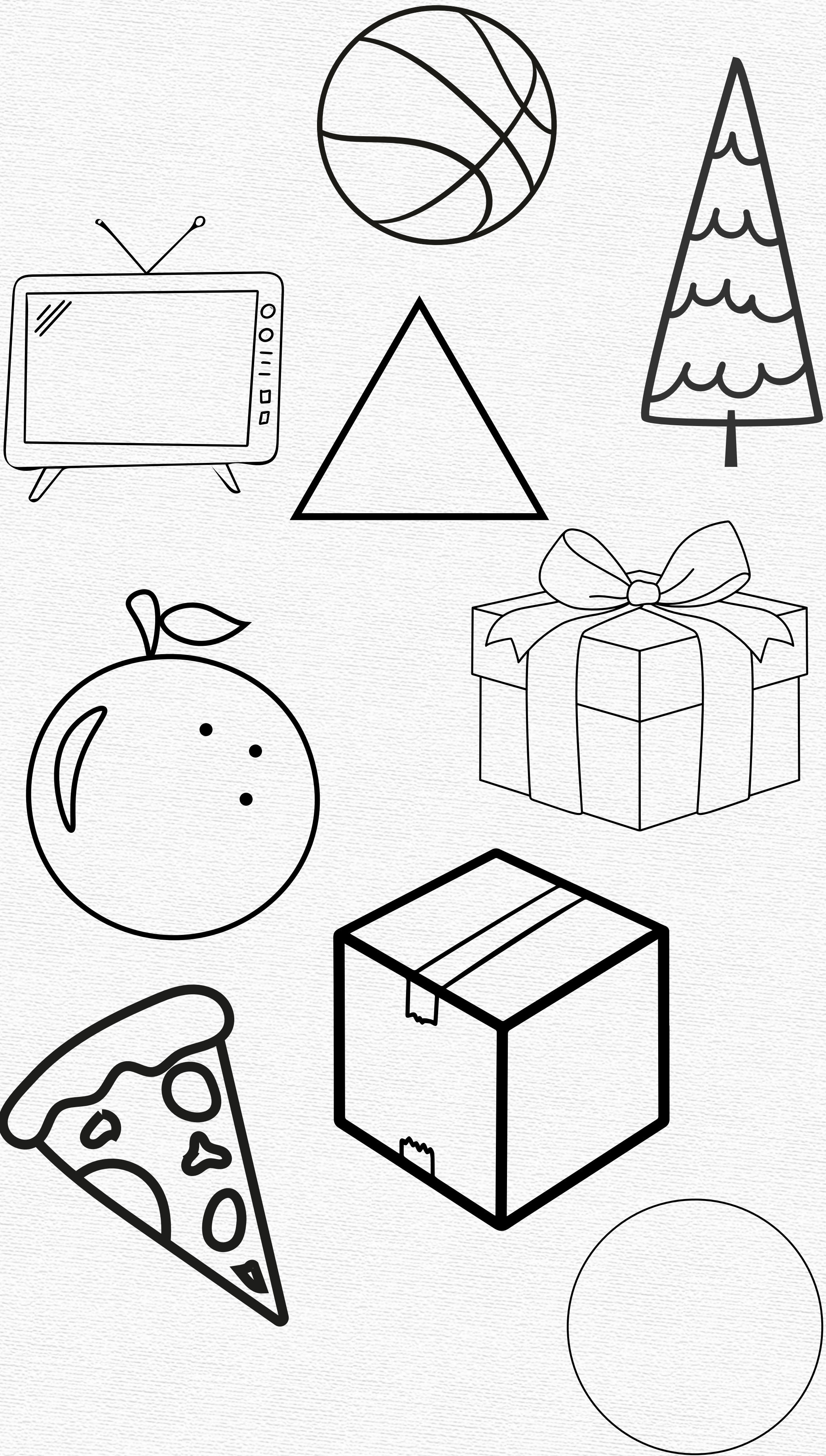

Help the animals!

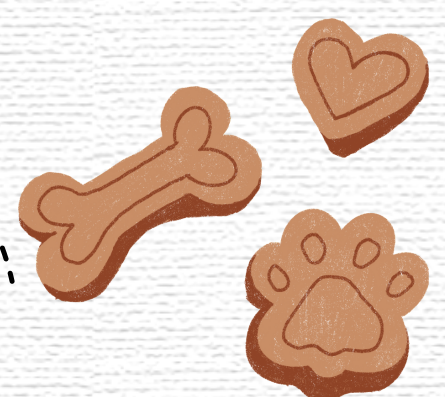
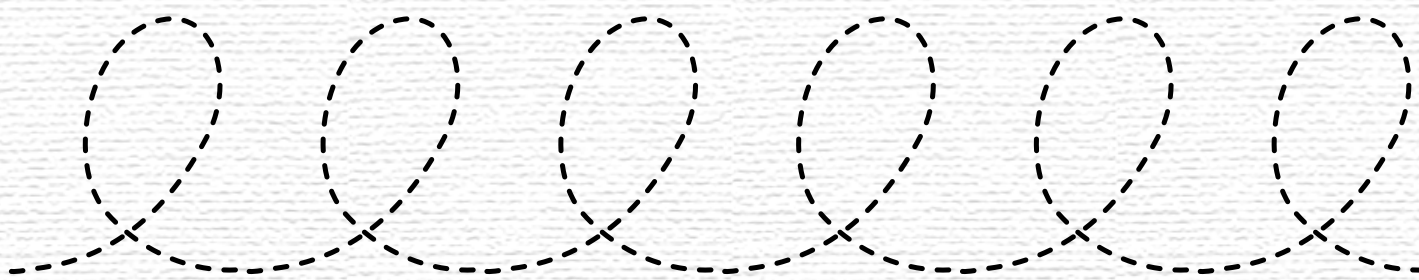
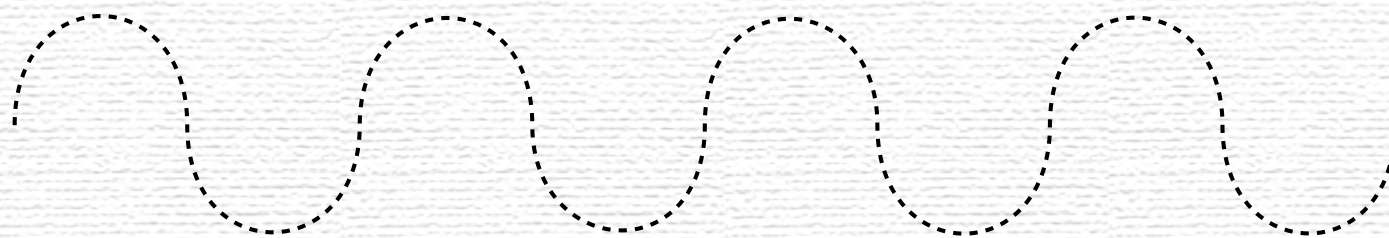
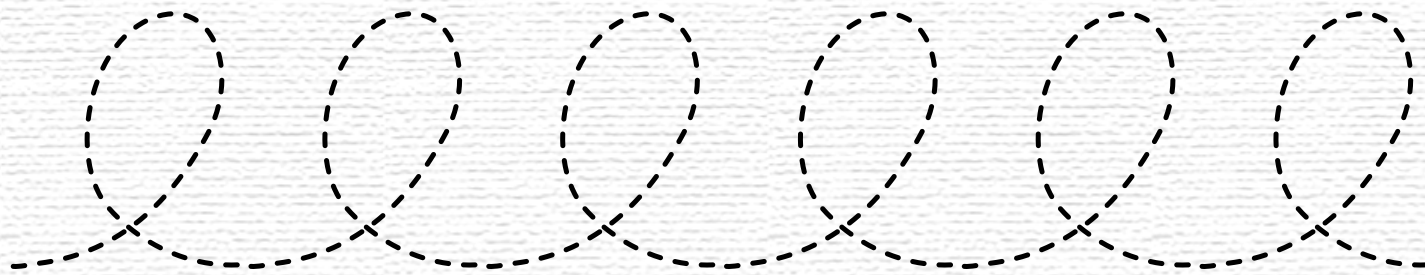
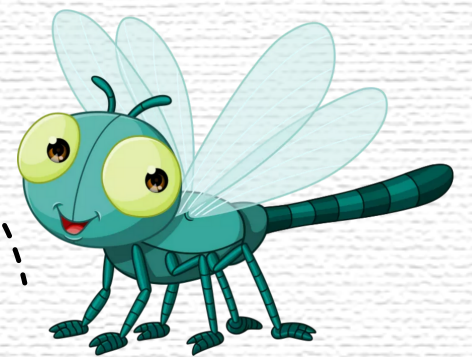
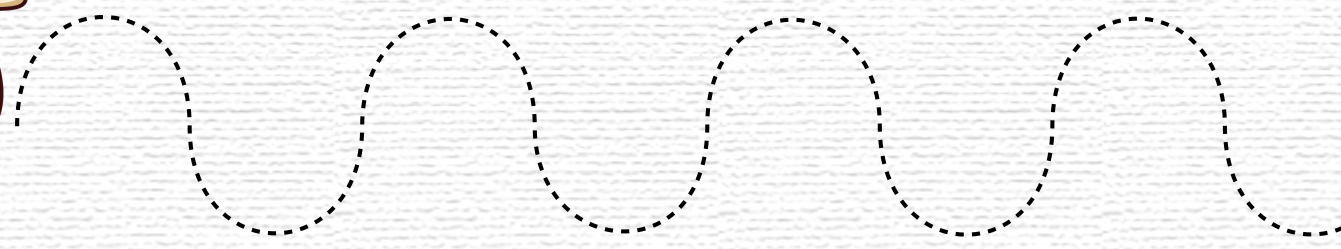

Parts of the body

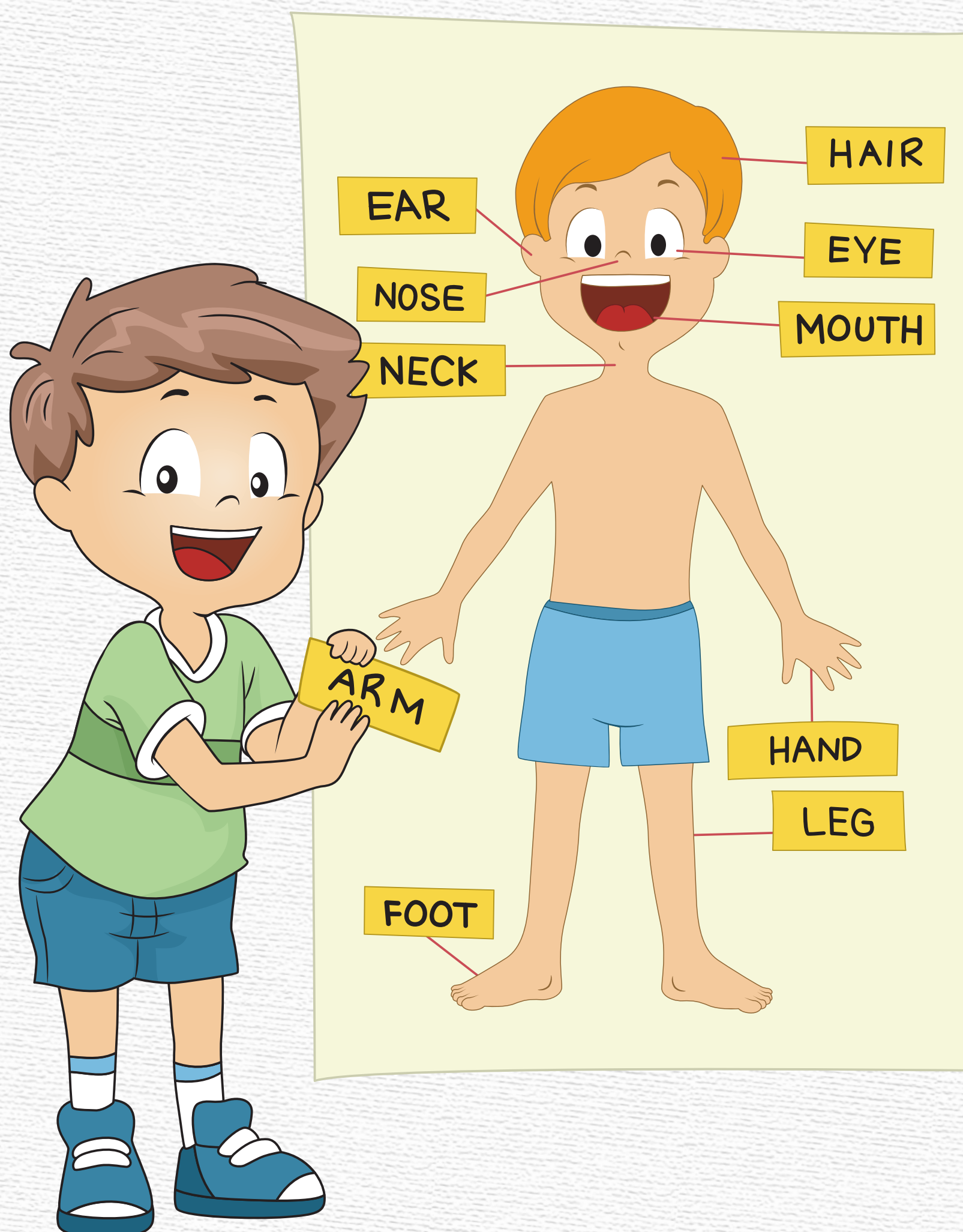

Draw a line and connect the body parts!

forehead

hair

cheeks

eyes

mouth

nose

ears

arms

neck

feet

legs

teeth

stomach

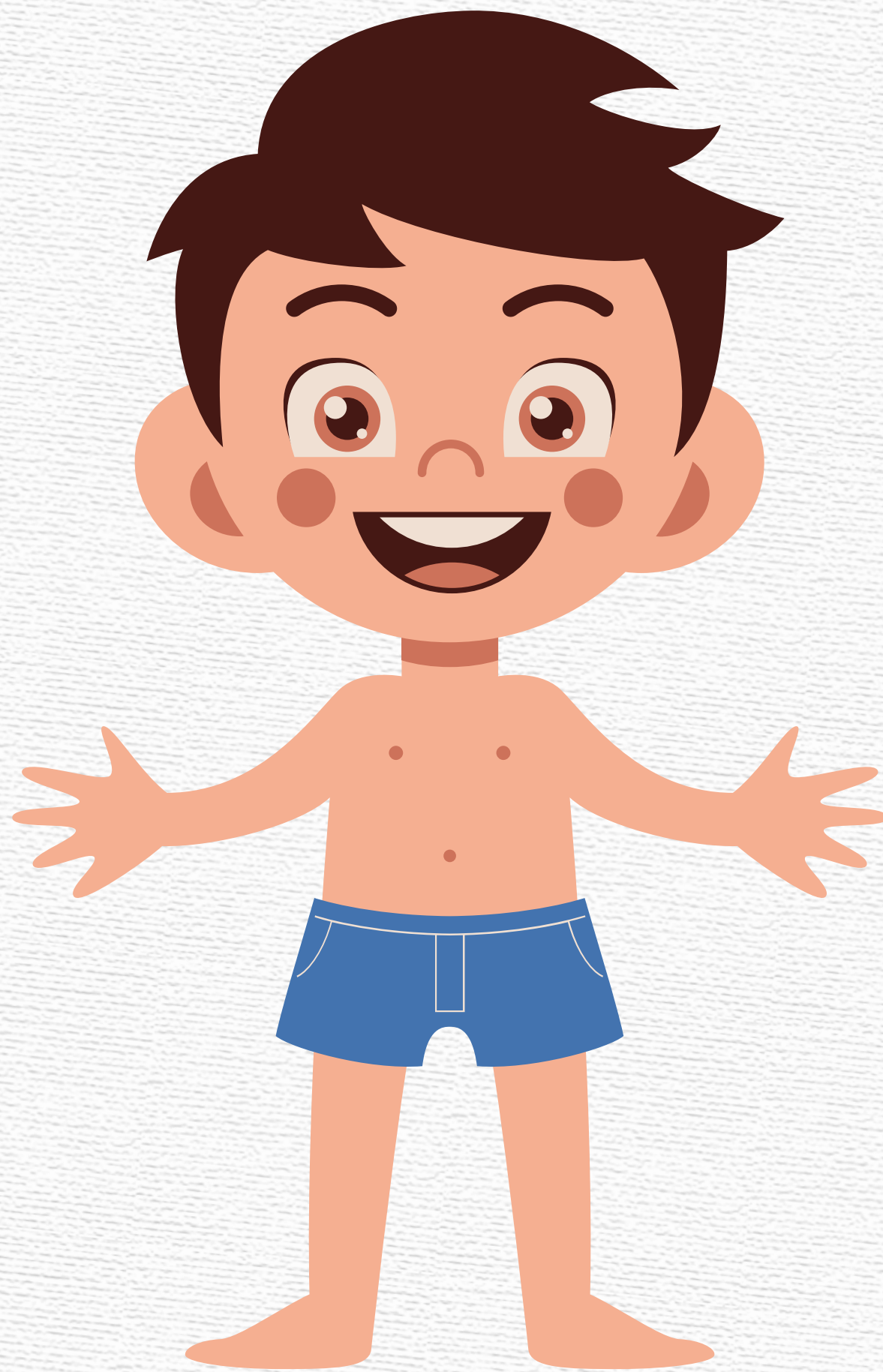

The Five Senses:

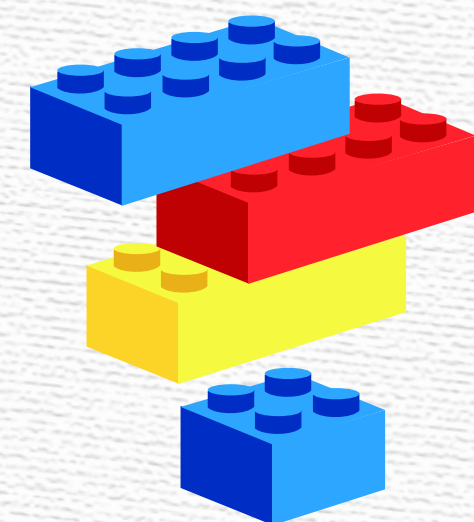
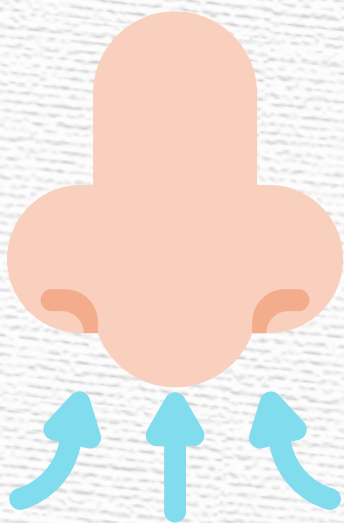
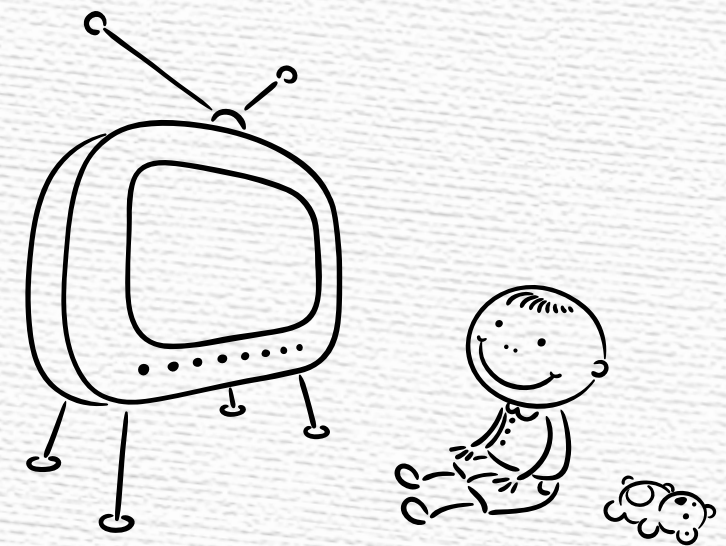
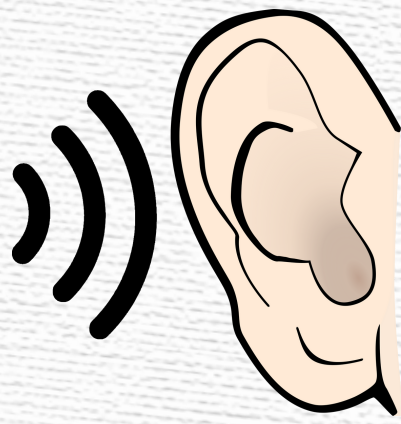
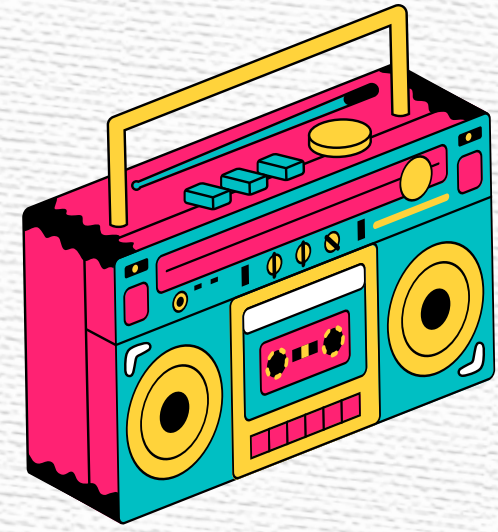
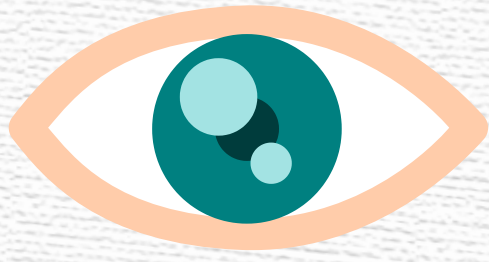

Match your body parts to the correct objects

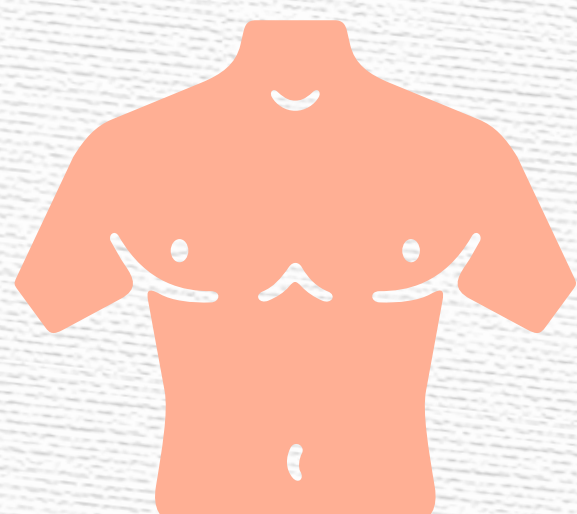
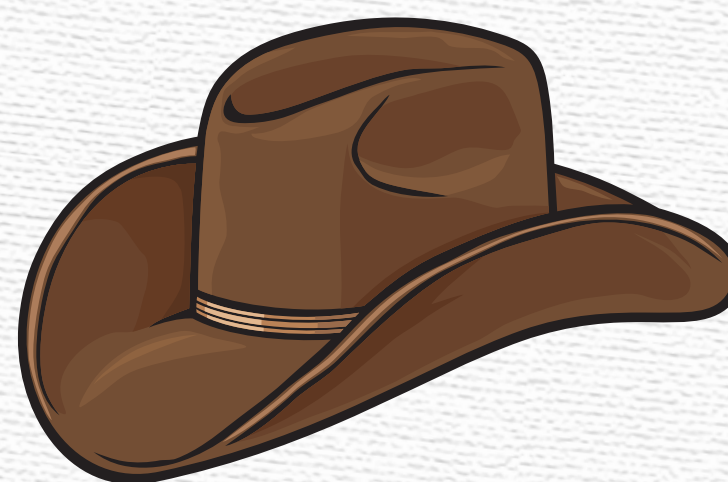
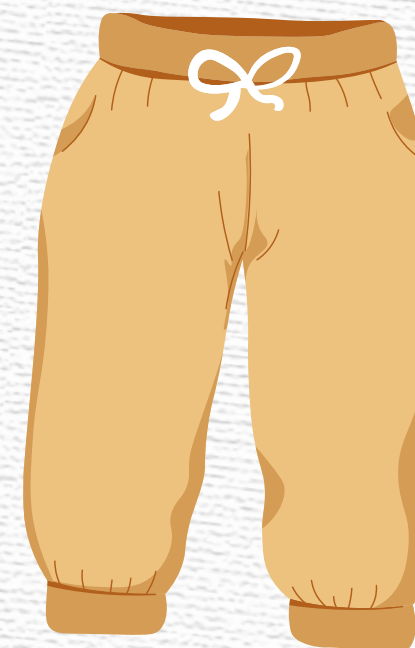
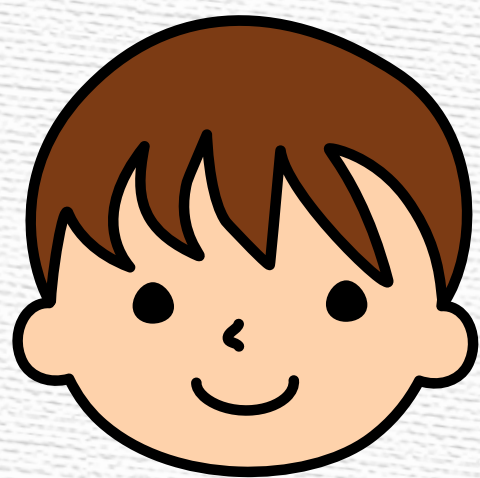

Match the people to the correct emotions



Match the people to the correct emotions

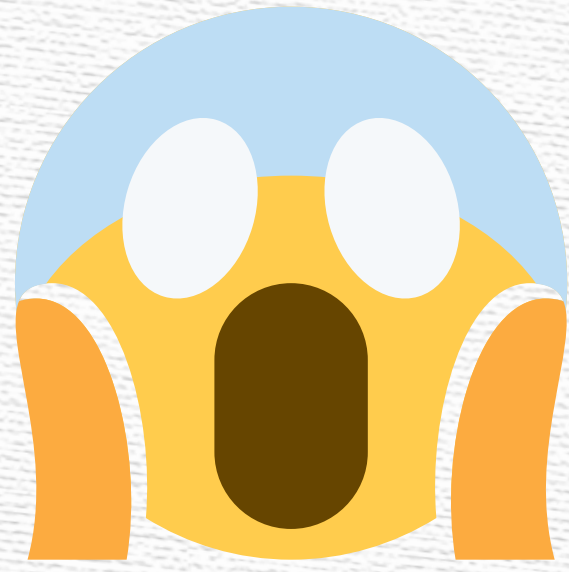

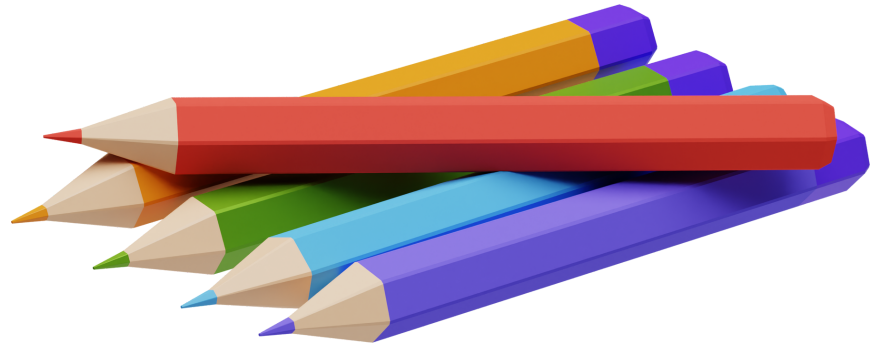

COLORING

BOOK

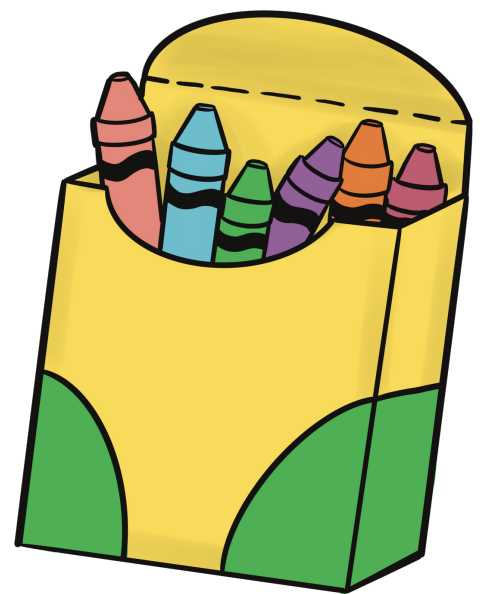
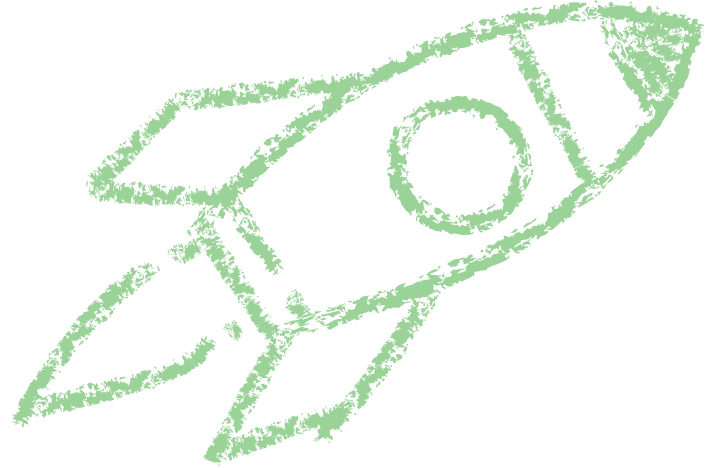

ABC

